

A
AANSLUITKLEM KLEMMENKAST
φ ANSCHLUSSKLEMME KLEMMKASTEN
TERMINAL CONNECTION BOX

AANSLUITKLEM TRANSISTOR
⊕ ANSCHLUSSKLEMME TRANSISTOR
TERMINAL TRANSISTOR

AANSLUITKLEM PLC-SLAVE
φ ANSCHLUSSKLEMME SPS-SLAVE
TERMINAL PLC-SLAVE

AANSLUITKLEM BEDIENINGSKAST
φ ANSCHLUSSKLEMME STEUERPUIT
TERMINAL CONTROL BOX

AANSLUITKLEM PLC
⊕ ANSCHLUSSKLEMME SPS
TERMINAL PLC

TYPE	OMSCHRIJVING UMSCHREIBUNG DESCRIPTION	PLC PROG: SPS PROG: PLC PROG:
M250-HYBRID	PROTO	M-H-01A
REV.	DATUM DATUM DATE	OPMERKING BEMERKUNG REMARK

this drawing is property of Holland Lift International, by all rights reserved
diese zeichnung ist eigentum von Holland Lift International, by all rights reserved
deze tekening is eigendom van Holland Lift International, by auteursrecht voorbehouden volgens de wet



Holland Lift International B.V.
Anodeweg 1
NL-1627 LJ Hoorn The Netherlands
T/F +31 (0)229-285555 / 285550
E service@hollandlift.com
W www.hollandlift.com

INDEX BLAD
INDEX BLATT
INDEX SHEET

Projekt: EM-21-001	Zeichnungsnummer:	Rev.:	erstellt von: Rothenbusch
Datum: 24.11.2014	Antage: =	Ort: +	Blatt: 1

A
B
C
D
E
F

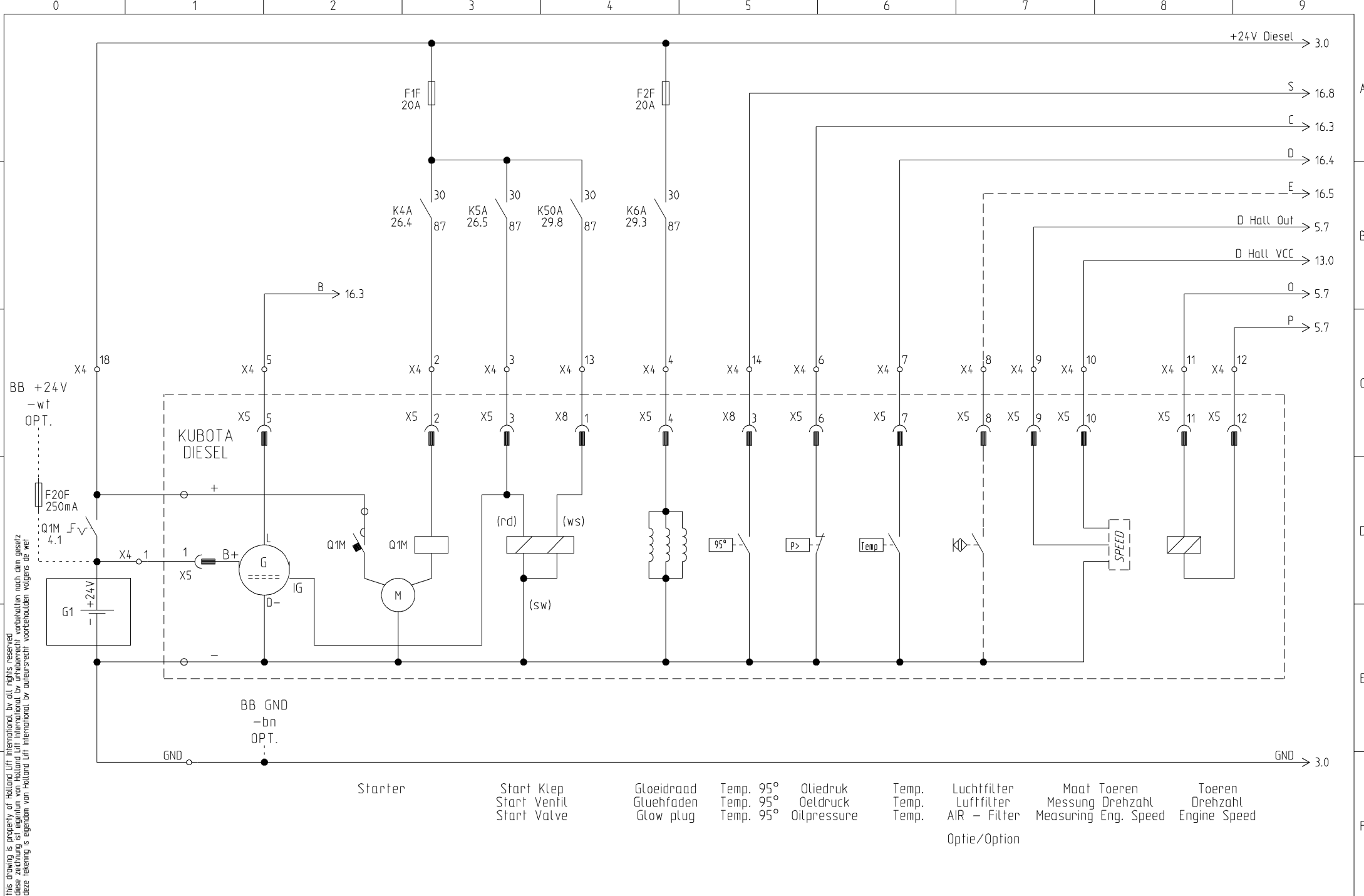

this drawing is property of Holland Lift International, by all rights reserved
 deze tekening is eigendom van Holland Lift International, by all rights reserved
 deze tekening is eigendom van Holland Lift International, by all rights reserved

Starter

Start Klep
Start Ventil
Start Valve

Gloeidraad
Glow plug

Temp. 95°
Temp. 95°
Temp. 95°
Oliedruk
Oilpressure

Temp.
Temp.
Temp.
Luchtfilter
Air - Filter

Maat Toeren
Messing Eng. Speed

Toeren
Drehzahl
Engine Speed

Optie/Option



Holland Lift International B.V.
Anodeweg 1
NL-1627 LJ Hoorn The Netherlands
T/F +31 (0)229-285555 / 285550
E service@hollandlift.com
W www.hollandlift.com

STROOMKRINGSCHEMA
STROMLAUFPLAN
CIRCUIT DIAGRAM

Projekt: EM-21-001
Datum: 24.11.2014

Zeichnungsnummer:
Anlage: =

Rev.:
Ort: +

erstellt von:
Rothenbusch
Blatt: 2

this drawing is property of Holland Lift International, by all rights reserved.
 deze tekening is eigendom van Holland Lift International, by auteursrecht voorbehouden volgens de wet

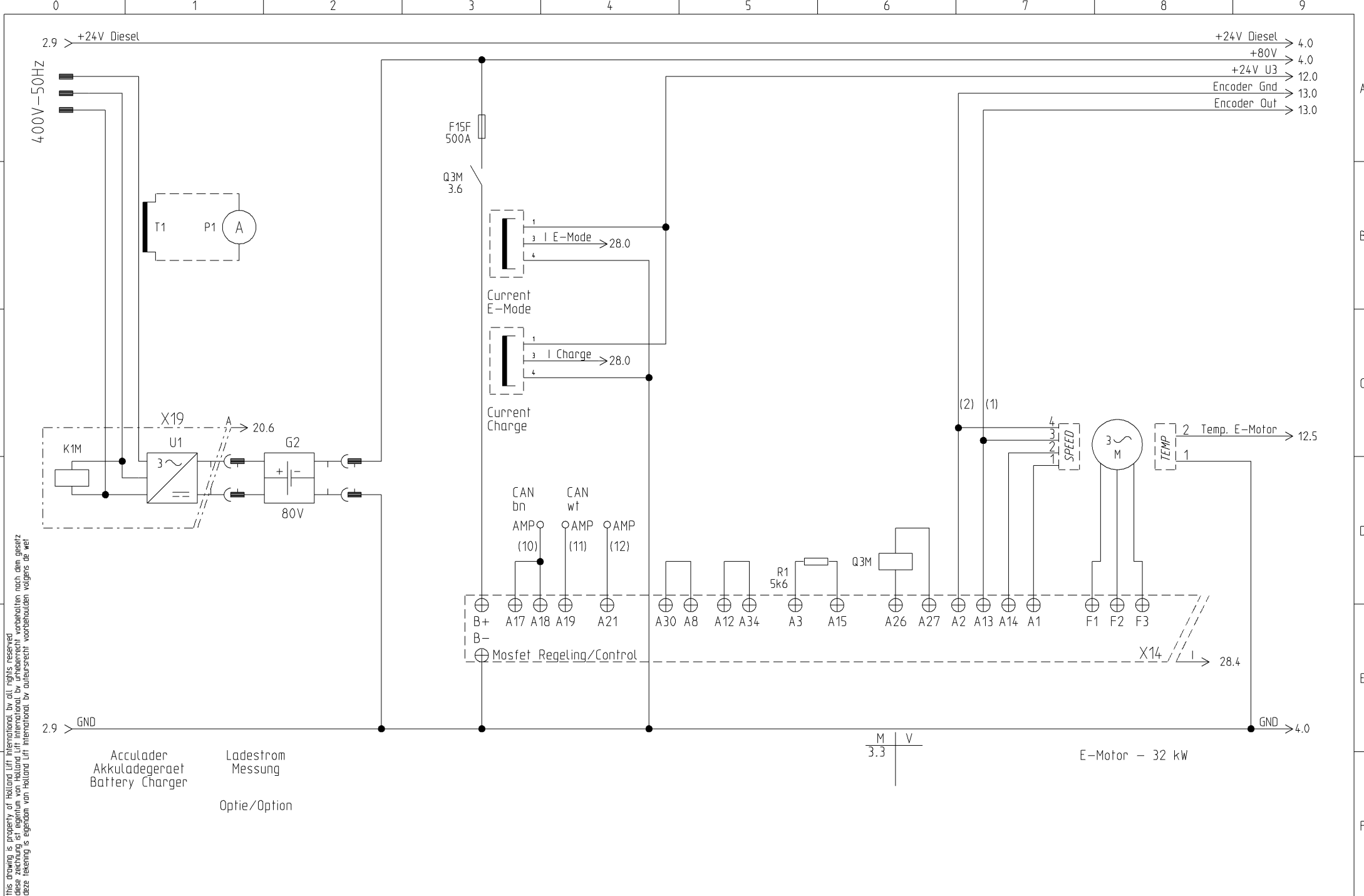

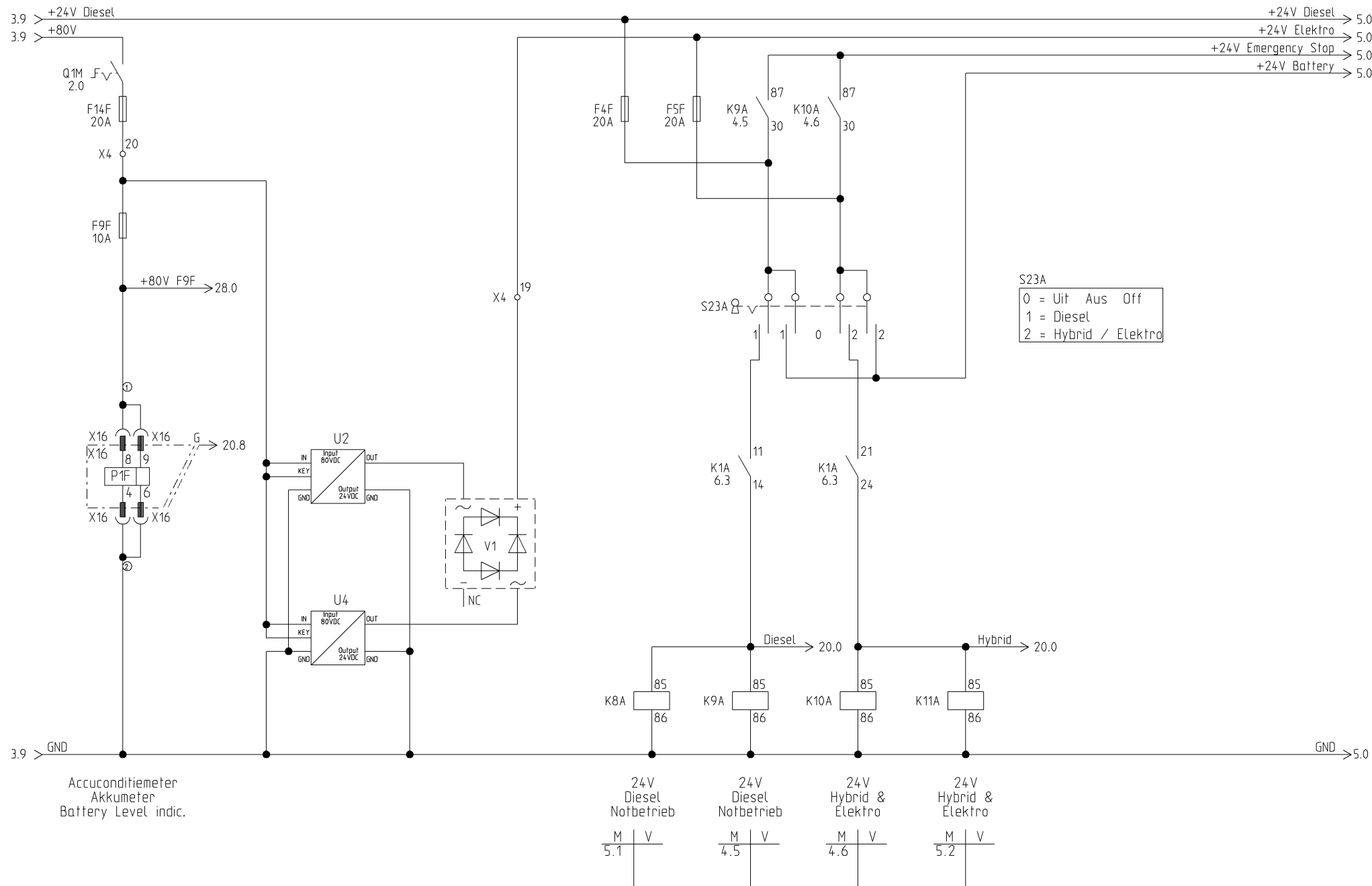

S23A
 0 = Uit Aus Off
 1 = Diesel
 2 = Hybrid / Elektro

Accuconditiometer
 Akkumefer
 Battery Level indic.

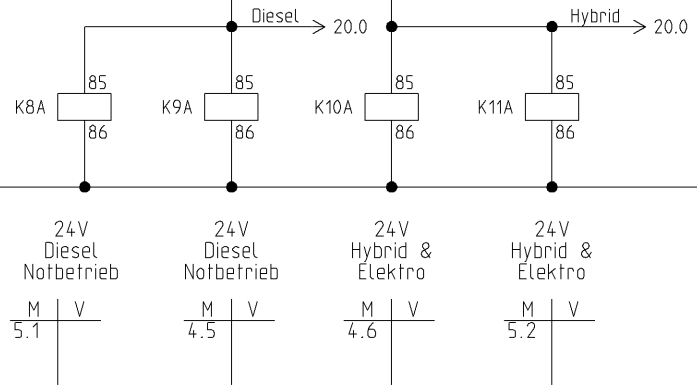

this drawing is property of Holland Lift International. All rights reserved.
 deze tekening is eigendom van Holland Lift International. Alle rechten voorbehouden volgens de wet.
 this drawing is property of Holland Lift International. All rights reserved.
 diese Zeichnung ist Eigentum von Holland Lift International. Alle Rechte vorbehalten nach dem Gesetz.
 deze tekening is eigendom van Holland Lift International. Alle rechten voorbehouden volgens de wet.



Holland Lift International B.V.
 Anodeweg 1
 NL-1627 LJ Hoorn The Netherlands
 T/F +31 (0)229-285555 / 285550
 E service@hollandlift.com
 W www.hollandlift.com

STROOMKRINGSCHEMA
 STROMLAUFPLAN
 CIRCUIT DIAGRAM

Projekt:	EM-21-001	Zeichnungsnummer:	Rev.:	erstellt von:
Datum:	24.11.2014	Anlage:	Ort:	Rothenbusch
				Blatt:
				4

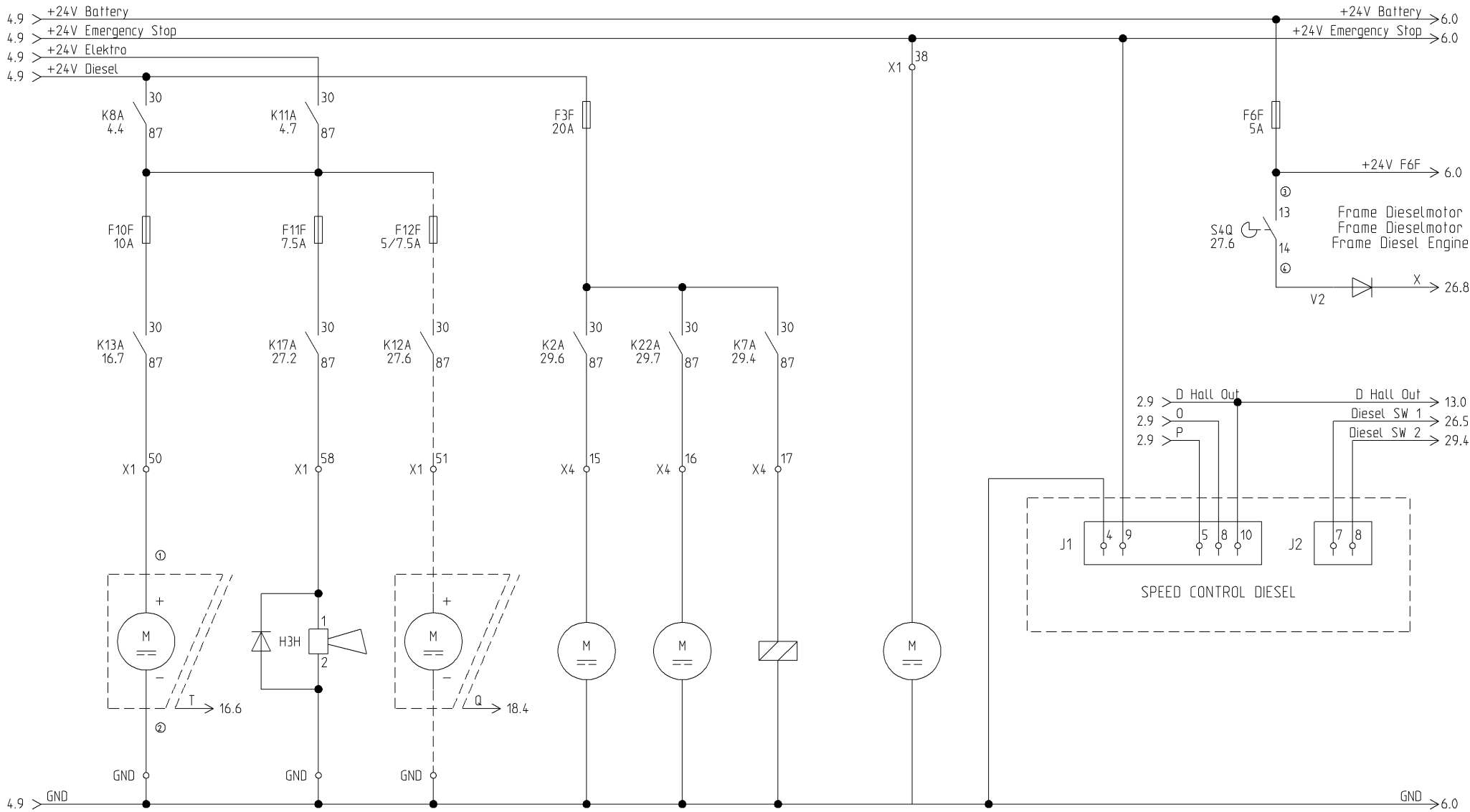

Koeler Hd. Olie
Kuehler Hd. Oel
Cooler Hd. Oil

Claxon
Hupe
Horn

Vetpomp
Fett Pumpe
Grease Pump
Optie/Option
Zie Blz 32-34
S. Blatt 32-34
See Page 32-34

Koeler 1
Kuehler 1
Cooler 1

Koeler 2
Kuehler 2
Cooler 2

Koppeling
Kupplung
Clutch

Koeler Mosfet Regeling
Kuehler Mosfet Regeling
Cooler Mosfet Control

Mosfet Regeling/Control

Toeren Controle Diesel
Drehzahlregelung Diesel
Speed Control Diesel

this drawing is property of Holland Lift International. All rights reserved.
 deze tekening is eigendom van Holland Lift International. Bij auteursrecht voorbehouden na het gezet.
 deze tekening is eigendom van Holland Lift International. Bij auteursrecht voorbehouden volgens de wet.

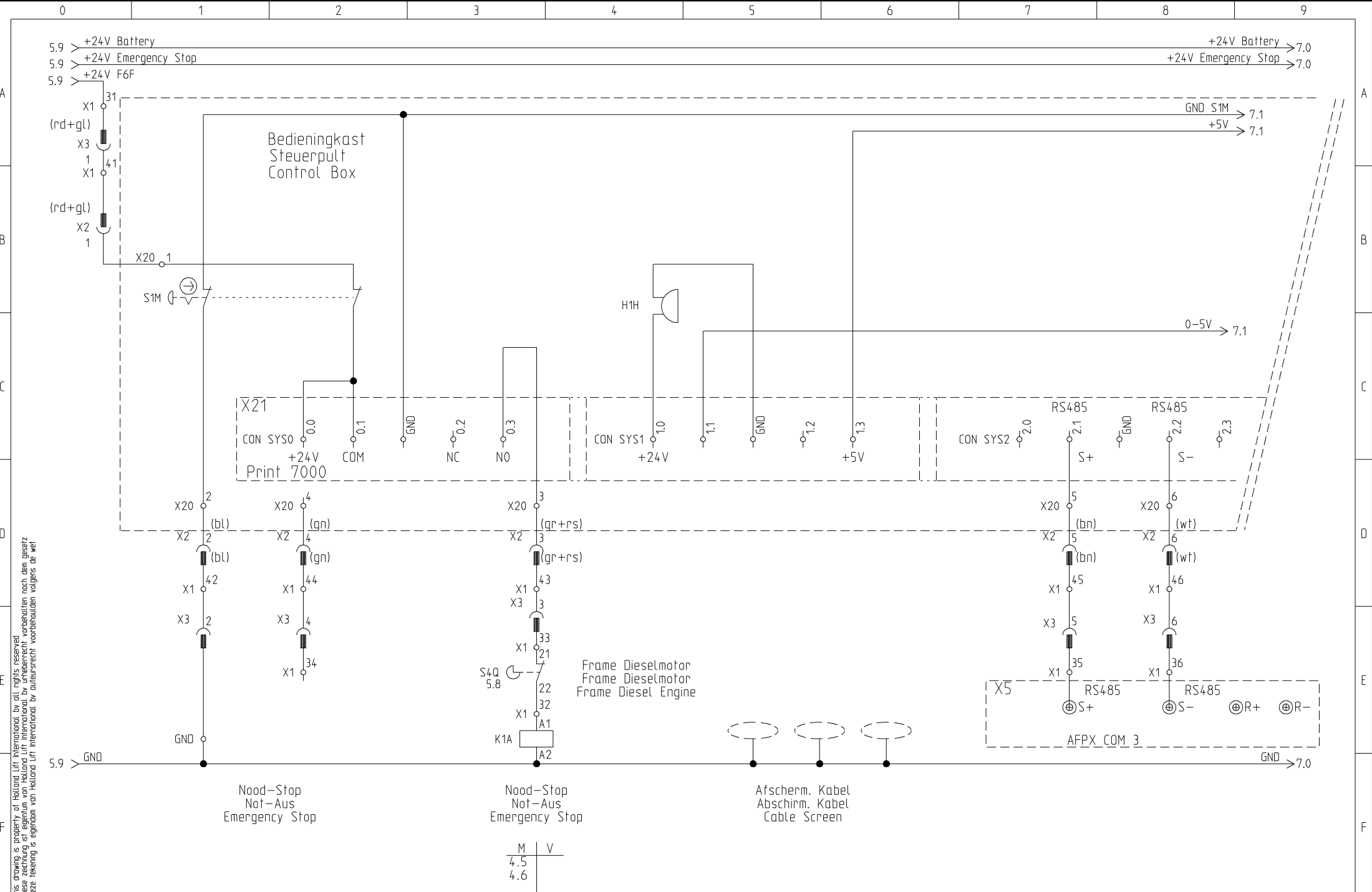

this drawing is property of Holland Lift International, by all rights reserved
 deze tekening is eigendom van Holland Lift International, by all rights reserved
 deze tekening is eigendom van Holland Lift International, by all rights reserved



Holland Lift International B.V.
 Anodeweg 1
 NL-1627 LJ Hoorn The Netherlands
 T/F +31 (0)229-285555 / 285550
 E service@hollandlift.com
 W www.hollandlift.com

STROOMKRINGSCHEMA
 STROMLAUFPLAN
 CIRCUIT DIAGRAM

Projekt: EM-21-001
 Datum: 24.11.2014

Zeichnungsnummer:
 Anlage: =

Rev.:
 Ort: +

erstellt von: Rothenbusch
 Blatt: 6

M	V
4.5	
4.6	

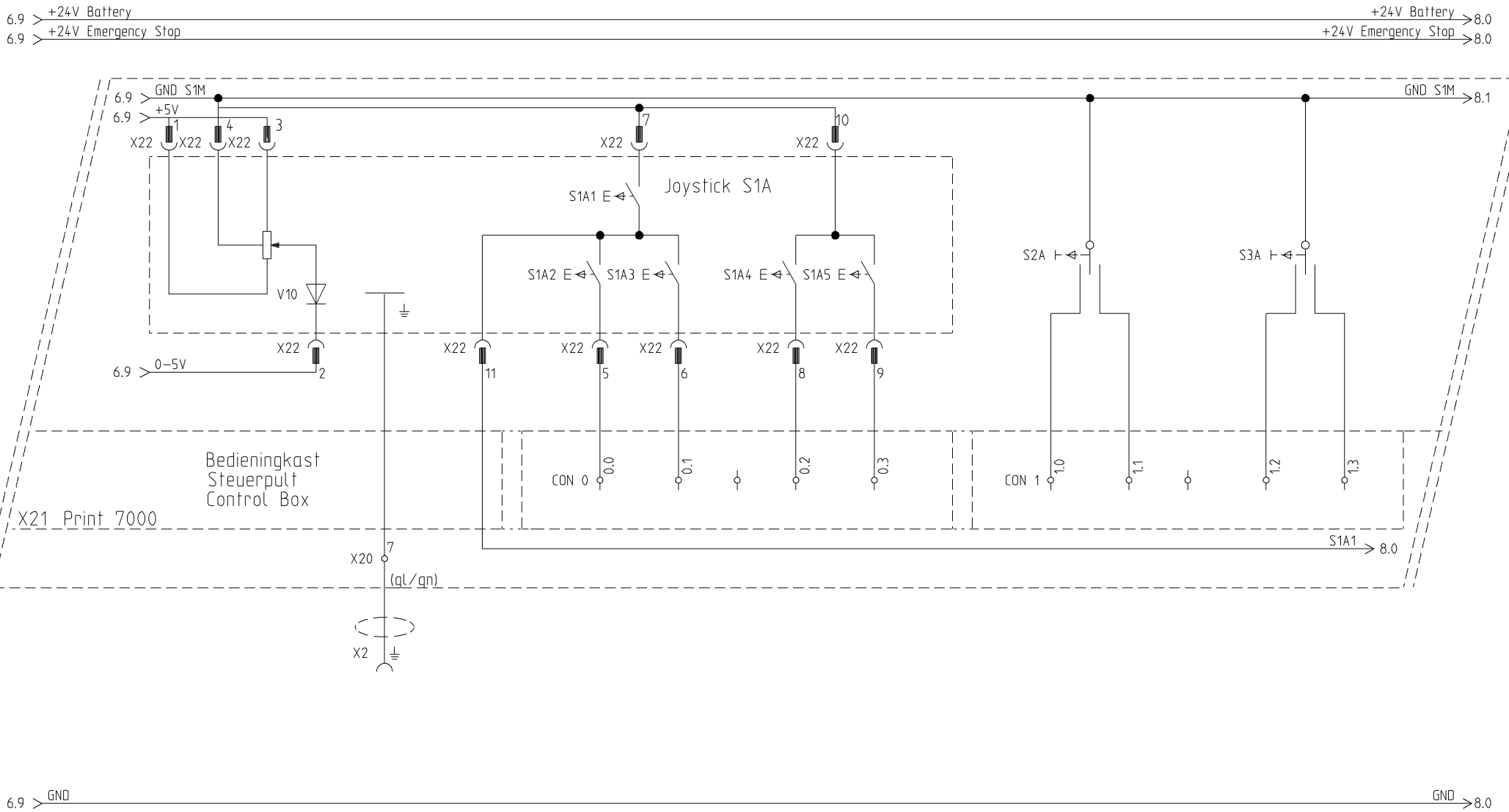

S1A1 Dodemansknop
 S1A1 Totmansknop
 S1A1 Dead Man,s Button

Op-Joysick-Neer
 Auf-Joystick-Nieder
 On-Joystick-Down

Links-Sturen-Rechts
 Links-Lenken-Rechts
 Left-Steering-Right

Claxon-Sign.gever
 Hupe-Signalgeber
 Horn-Signal

Sper/Diff
 Sperr/Diff
 Stip/Diff

Heffen/Dalen
 Heben/Senken
 Lift Up/Lift Down

Rijden/Sturen
 Fahren/Lenken
 Driving/Steering

this drawing is property of Holland Lift International, by all rights reserved
 deze tekening is eigendom van Holland Lift International, by all rights reserved
 deze tekening is eigendom van Holland Lift International, by all rights reserved

7.9 > +24V Battery
 7.9 > +24V Emergency Stop

+24V Battery > 9.0
 +24V Emergency Stop > 9.0

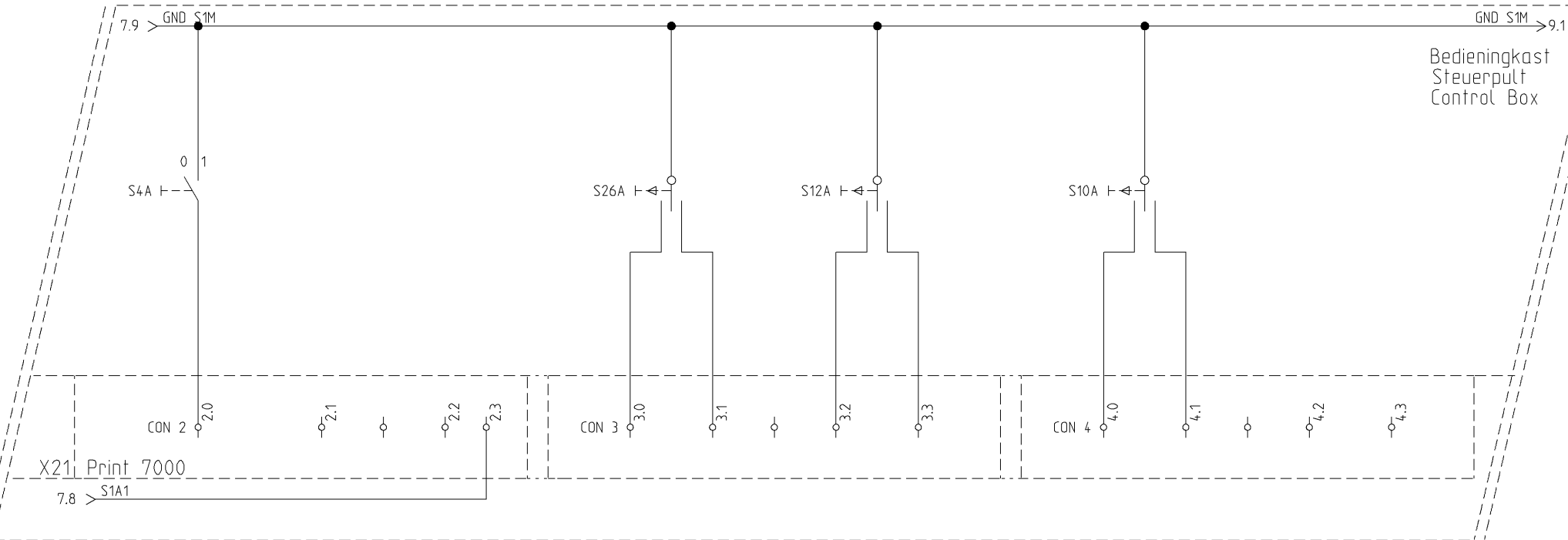

X21, Print 7000
 7.8 > S1A1

S4A
 0 = Langzaam Langsam Slow
 1 = Snel Schnell Fast

7.9 > GND GND > 9.0

Snelheid
 Geschwindigkeit
 Speed

S1A1 Dodemansknop
 S1A1 Totmansknopf
 S1A1 Dead Man's Button

Hybrid Elektro
 — Mode —

4xN-Stempels-Autom. Niveleer
 4xN-Stuetzen-Autom. Nivel.
 4xN-Jack-Autom. Nivel

In-Plattform-Uit
 Ein-Plattform-Aus
 In-Plattform-Out

this drawing is property of Holland Lift International, by all rights reserved
 deze tekening is eigendom van Holland Lift International, by all rights reserved
 deze tekening is eigendom van Holland Lift International, by auteursrecht voorbehouden volgens de wet



Holland Lift International B.V.
 Anodeweg 1
 NL-1627 LJ Hoorn The Netherlands
 T/F +31 (0)229-285555 / 285550
 E service@hollandlift.com
 W www.hollandlift.com

STROOMKRINGSCHEMA
 STROMLAUFPLAN
 CIRCUIT DIAGRAM

Projekt: EM-21-001	Zeichnungsnummer:	Rev.:	erstellt von: Rothenbusch
Datum: 24.11.2014	Anlage: =	Ort: +	Blatt: 8

8.9 > +24V Battery
 8.9 > +24V Emergency Stop

+24V Battery > 10.0
 +24V Emergency Stop > 10.0

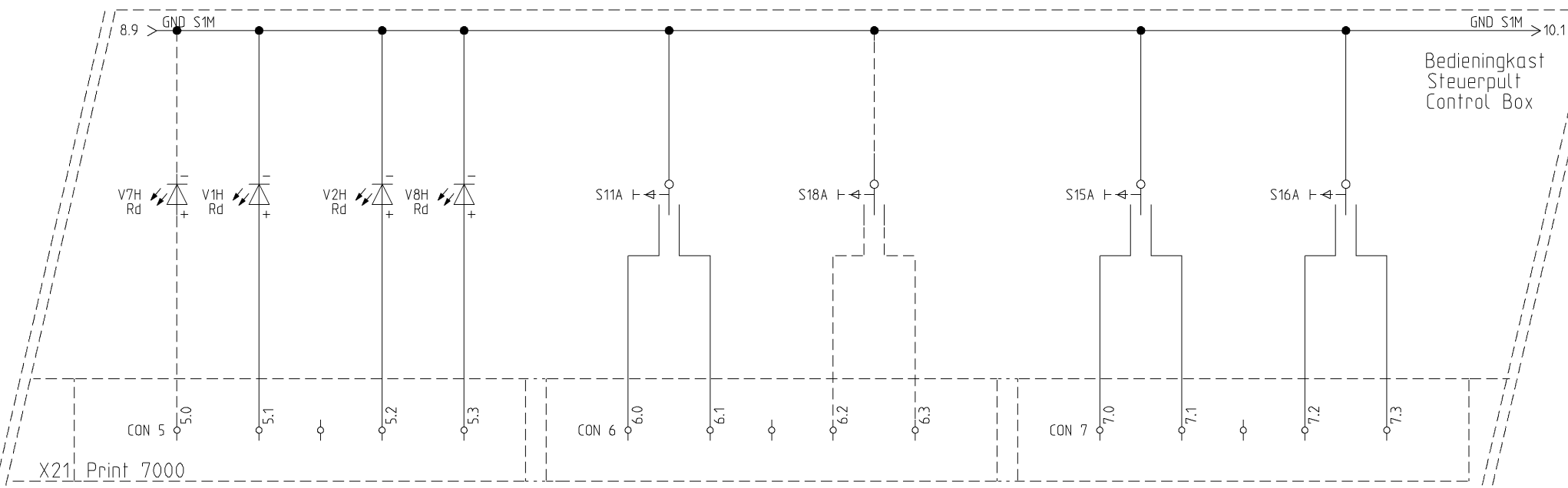

8.9 > GND GND > 10.0

Vetpomp Fett Pumpe Grease Pump	Overload Ueberlastung Overload	Scheefstand Neigung Grade/Slope	Tank leeg Tank leer Tank empty	Start - Motor - Stop Start - Motor - Halt Start - Engine - Stop	Aan Generator Uit An Generator Aus On Generator Off	LA in LH ein LR in	LA uit LH aus LR out	RA in RH ein RR in	RA uit RH aus RR out
Optie/Option				Optie/Option	Stempels-Stuetzen-Jacks		Stempels-Stuetzen-Jacks		

this drawing is property of Holland Lift International, by all rights reserved
 deze tekening is eigendom van Holland Lift International, by auteursrecht voorbehouden volgens de wet
 deze tekening is eigendom van Holland Lift International, by auteursrecht voorbehouden volgens de wet



Holland Lift International B.V.
 Anodeweg 1
 NL-1627 LJ Hoorn The Netherlands
 T/F +31 (0)229-285555 / 285550
 E service@hollandlift.com
 W www.hollandlift.com

STROOMKRINGSHEMA
 STROMLAUFPLAN
 CIRCUIT DIAGRAM

Projekt: EM-21-001	Zeichnungsnummer:	Rev.:	erstellt von: Rothenbusch
Datum: 24.11.2014	Anlage: =	Ort: +	Blatt: 9

9.9 > +24V Battery
 9.9 > +24V Emergency Stop

+24V Battery > 11.0
 +24V Emergency Stop > 11.0

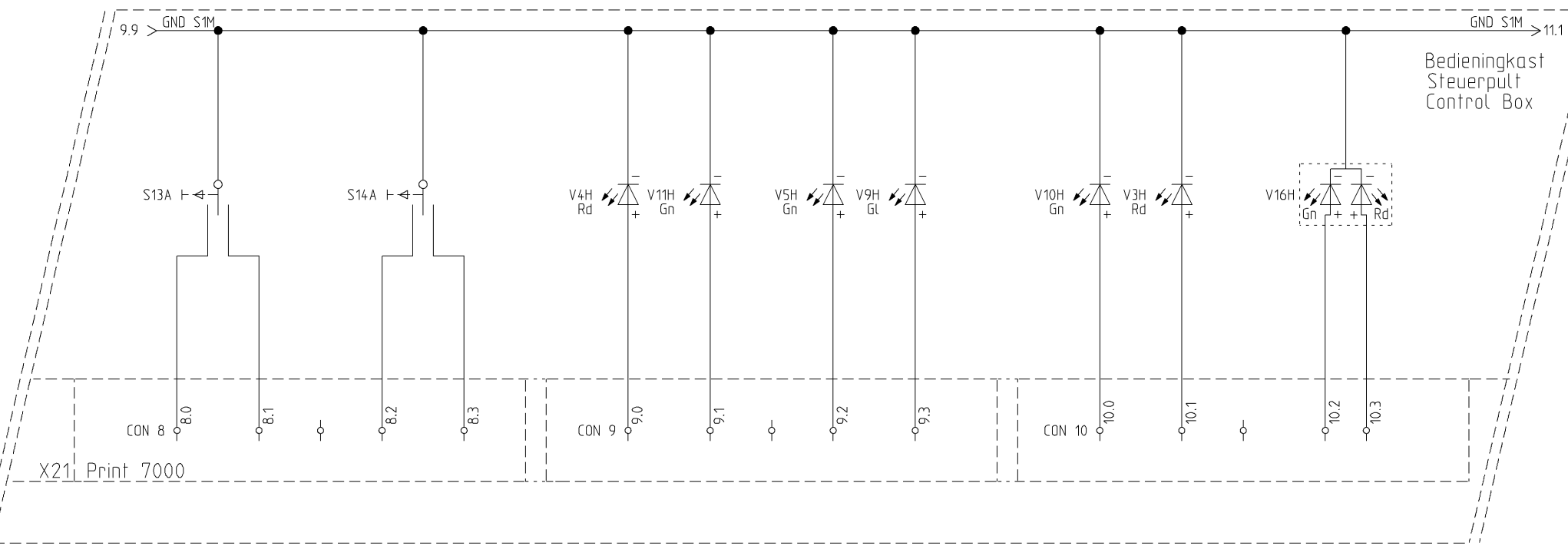

X21, Print 7000

9.9 > GND

GND > 11.0

LV in LV ein LF in	LV uit LV aus LF out	RV in RV ein RF in	RV uit RV aus RF out	Pendelas Horizontaal Pendel Achse Hor. Oscillating Axle Hor.	Stempels in Stuetzen ein Jacks in	Stempels uit Stuetzen aus Jacks out	Autom. Niv. Autom. Niv. Autom. Niv.	In Bedrijf In Betrieb Run	Storing Stoerung Failure	Accu geladen Akku geladen Battery loaded	Accu leeg Akku leer Battery empty
--------------------------	----------------------------	--------------------------	----------------------------	--	---	---	---	---------------------------------	--------------------------------	--	---

Stempels-Stuetzen-Jacks Stempels-Stuetzen-Jacks

Diesel Motor

this drawing is property of Holland Lift International, by all rights reserved
 deze tekening is eigendom van Holland Lift International, by all rights reserved
 deze tekening is eigendom van Holland Lift International, by auteursrecht voorbehouden volgens de wet



Holland Lift International B.V.
 Anodeweg 1
 NL-1627 LJ Hoorn The Netherlands
 T/F +31 (0)229-285555 / 285550
 E service@hollandlift.com
 W www.hollandlift.com

STROOMKRINGSCHEMA
 STROMLAUFPLAN
 CIRCUIT DIAGRAM

Projekt: EM-21-001	Zeichnungsnummer:	Rev.:	erstellt von: Rothenbusch
Datum: 24.11.2014	Anlage: =	Ort: +	Blatt: 10

10.9 > +24V Battery
 10.9 > +24V Emergency Stop

+24V Battery > 12.0
 +24V Emergency Stop > 12.0

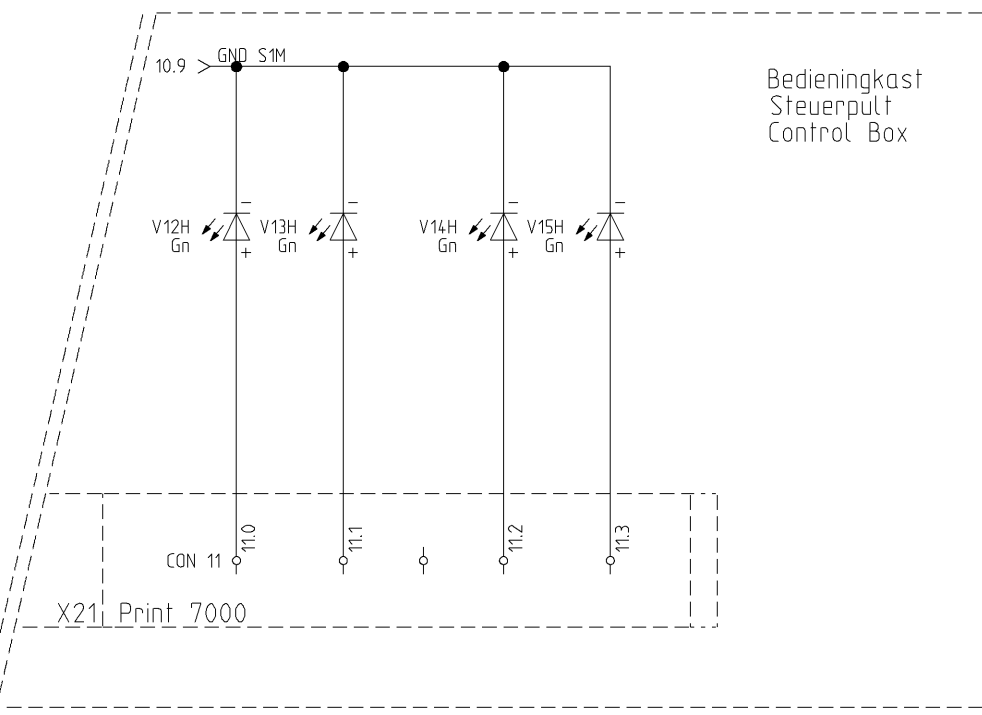

Bedieningkast
 Steuerpult
 Control Box

X21, Print 7000

10.9 > GND

GND > 12.0

Rijden/Sturen Heffen/Dalen Hybrid Elektro
 Fahren/Lenken Heben/Senken
 Driving/Steering Lift Up/Lift Down

this drawing is property of Holland Lift International, by all rights reserved
 deze tekening is eigendom van Holland Lift International, by all rights reserved
 deze tekening is eigendom van Holland Lift International, by all rights reserved

HOLLAND LIFT

Holland Lift International B.V.
 Anodeweg 1
 NL-1627 LJ Hoorn The Netherlands
 T/F +31 (0)229-285555 / 285550
 E service@hollandlift.com
 W www.hollandlift.com

STROOMKRINGSCHEMA
 STROMLAUFPLAN
 CIRCUIT DIAGRAM

Projekt:	EM-21-001	Zeichnungsnummer:	Rev.:	erstellt von:
Datum:	24.11.2014	Antage:	Ort:	Rothenbusch
		=	+	Blatt: 11

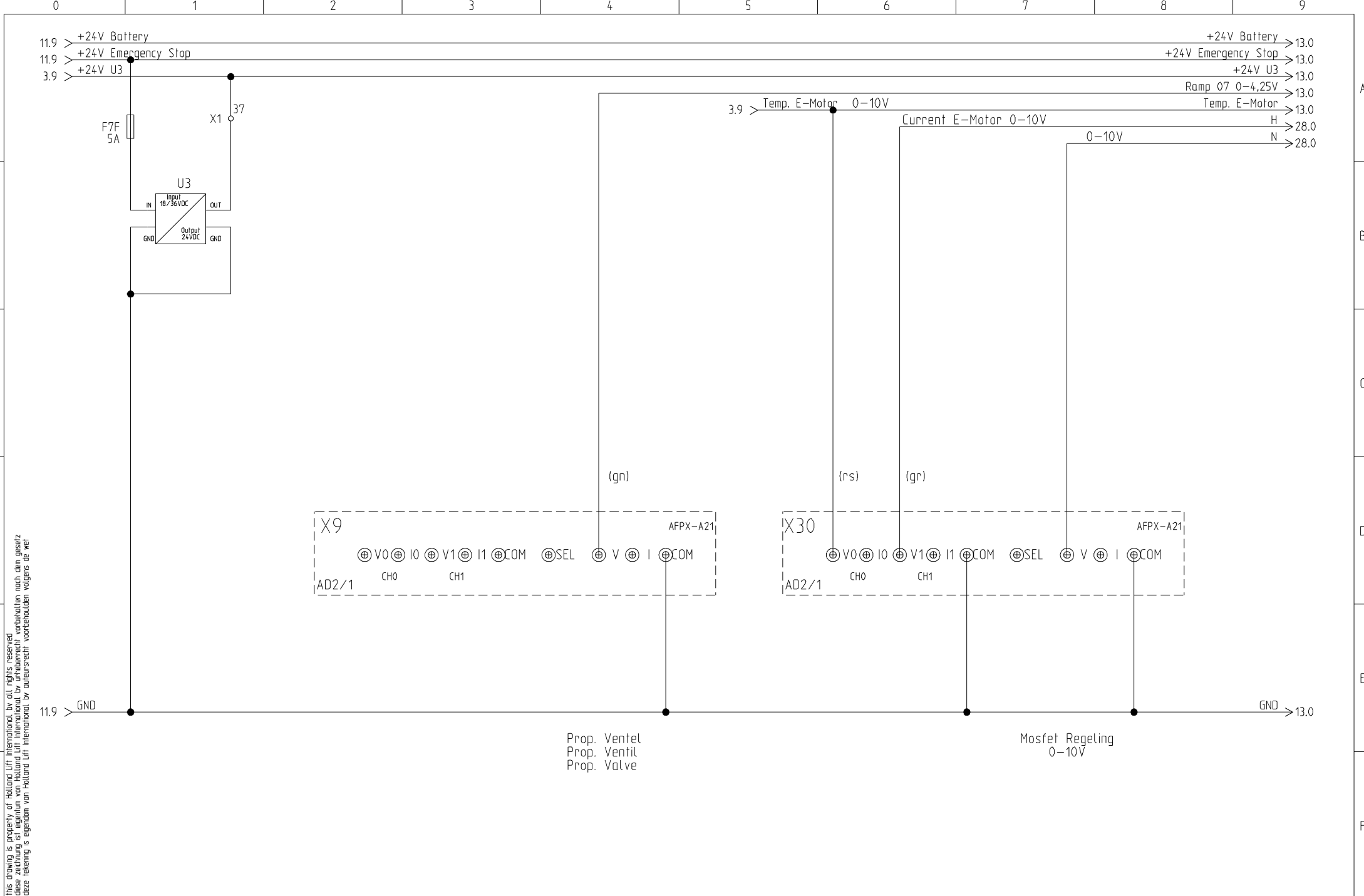

this drawing is property of Holland Lift International, by all rights reserved
 deze tekening is eigendom van Holland Lift International, by all rights reserved
 deze tekening is eigendom van Holland Lift International, by all rights reserved

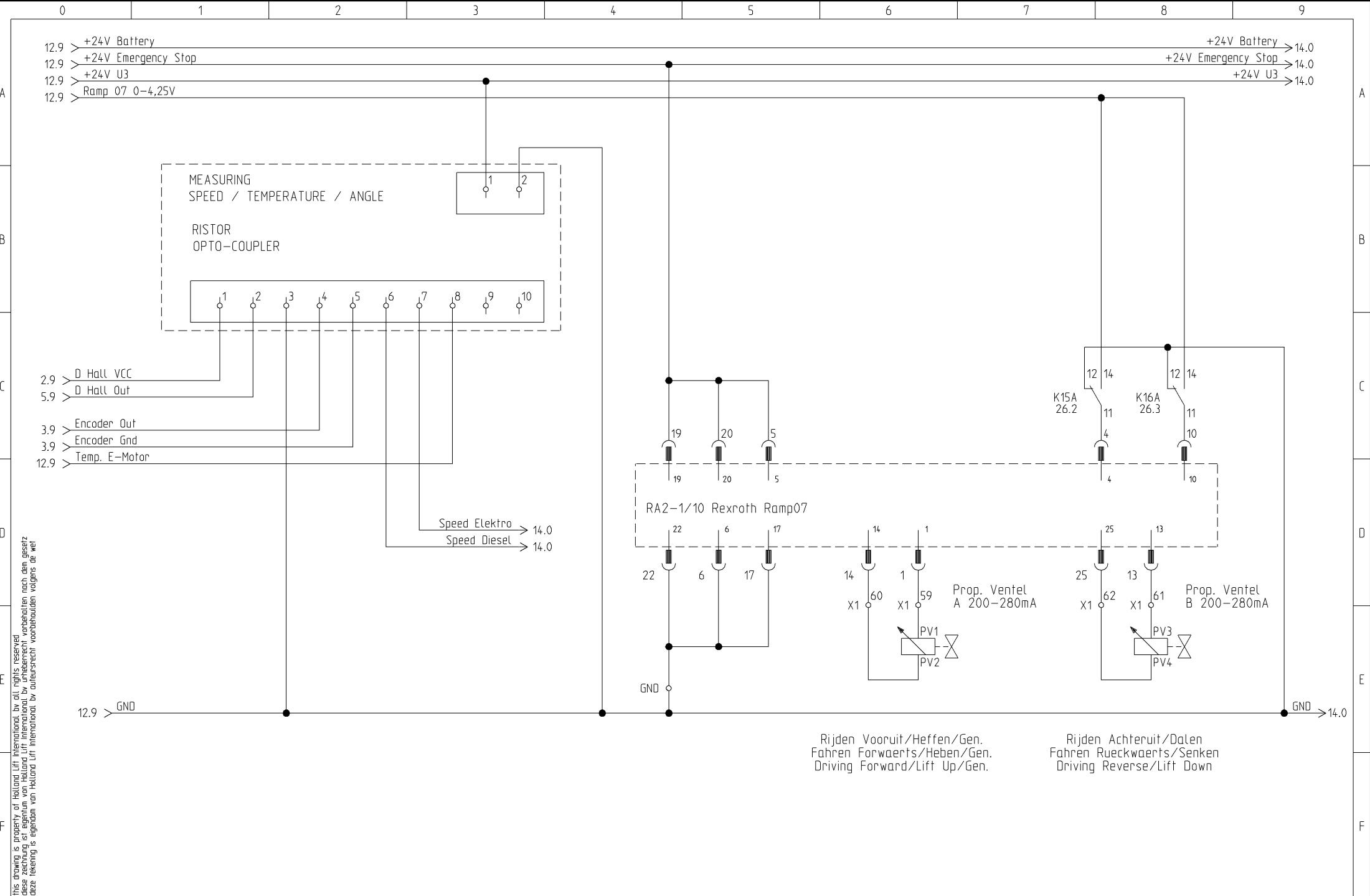

this drawing is property of Holland Lift International, by all rights reserved.
 deze tekening is eigendom van Holland Lift International, by all rights reserved.
 deze tekening is eigendom van Holland Lift International, by all rights reserved.

this drawing is property of Holland Lift International, by all rights reserved
 deze tekening is eigendom van Holland Lift International, by auteursrecht voorbehouden volgens de wet
 deze tekening is eigendom van Holland Lift International, by auteursrecht voorbehouden volgens de wet

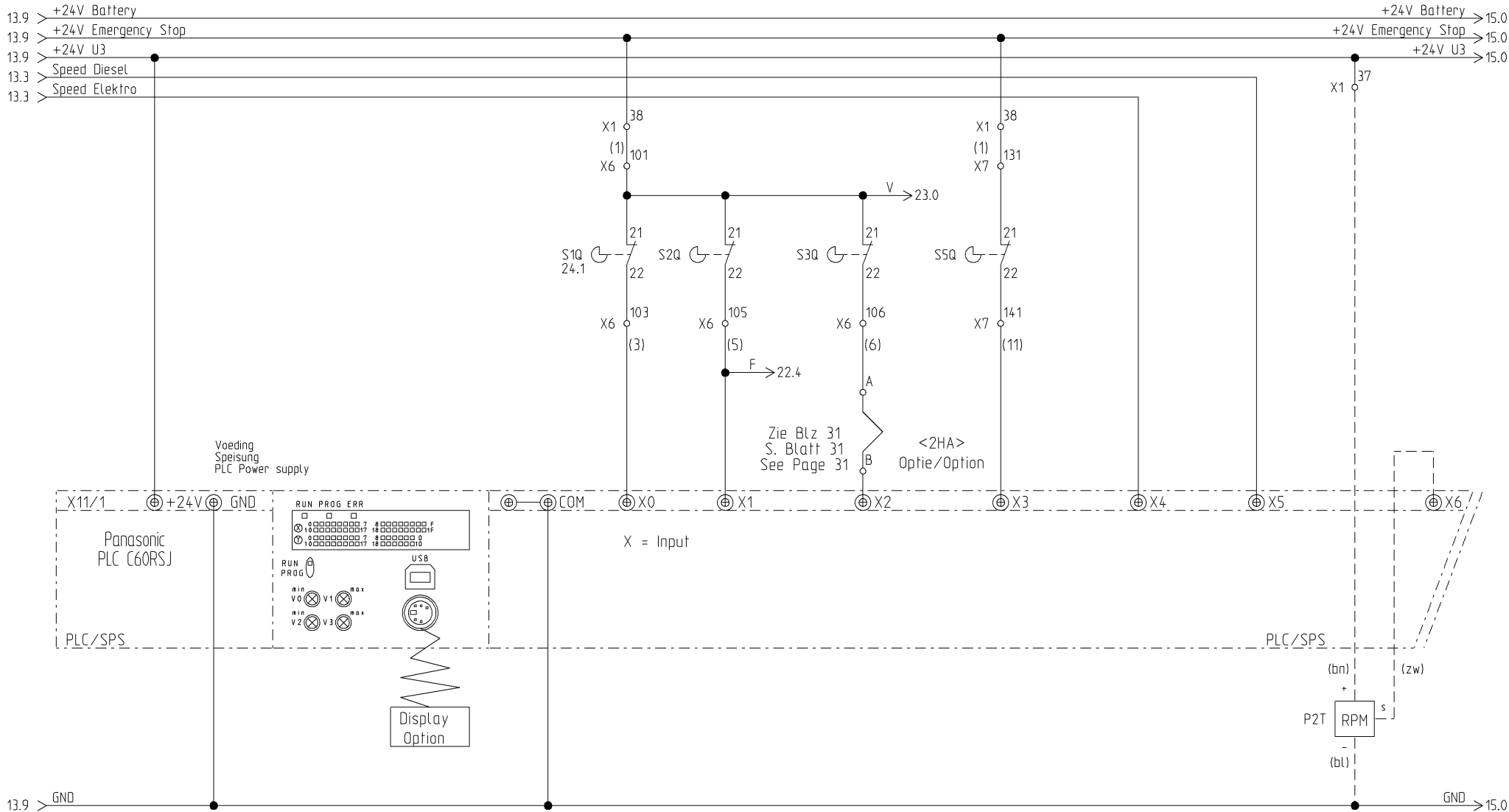

- 4 mtr. Afslag
4 mtr. Ausschalt.
4 mtr. Cut-Out
 - 8 mtr. Afslag
8 mtr. Ausschalt.
8 mtr. Cut-Out
 - Max. Hodgte
Max. Hoehe
Max. Height
 - Pendelas Horizontaal
Pendel Achse Hor.
Oscillating Axle Hor.
 - Toeren E.
Drehzahl E.
Speed E.
 - Toeren D.
Drehzahl D.
Speed D.
 - RPM Teller Gen.
RPM Zaehler Gen.
RPM Meter Gen.
- Optie/Option

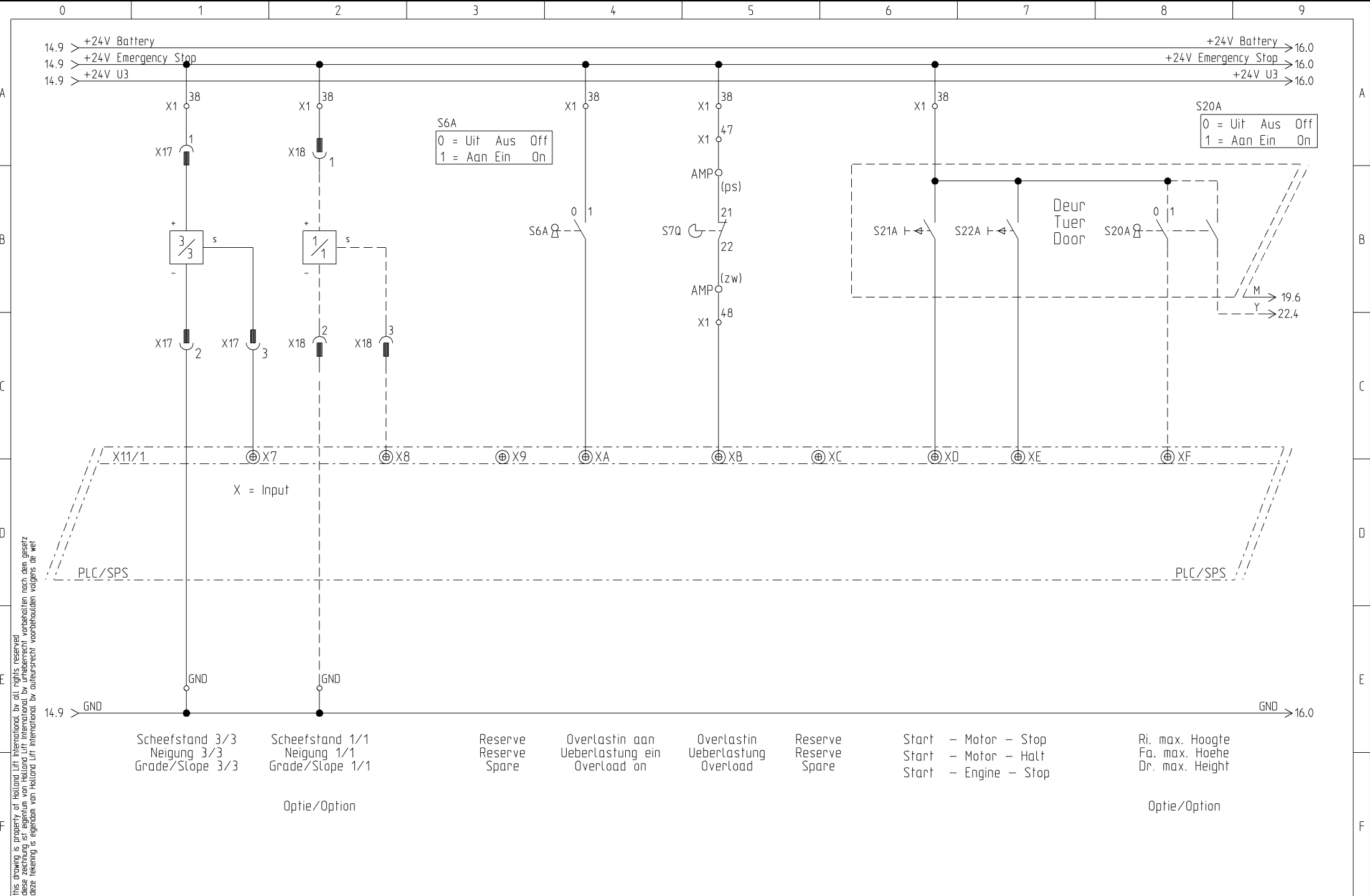

this drawing is property of Holland Lift International. All rights reserved.
 deze tekening is eigendom van Holland Lift International. Alle rechten voorbehouden.
 deze tekening is eigendom van Holland Lift International. Alle rechten voorbehouden volgens de wet.

this drawing is property of Holland Lift International, by all rights reserved
 deze tekening is eigendom van Holland Lift International, by all rights reserved
 deze tekening is eigendom van Holland Lift International, by all rights reserved

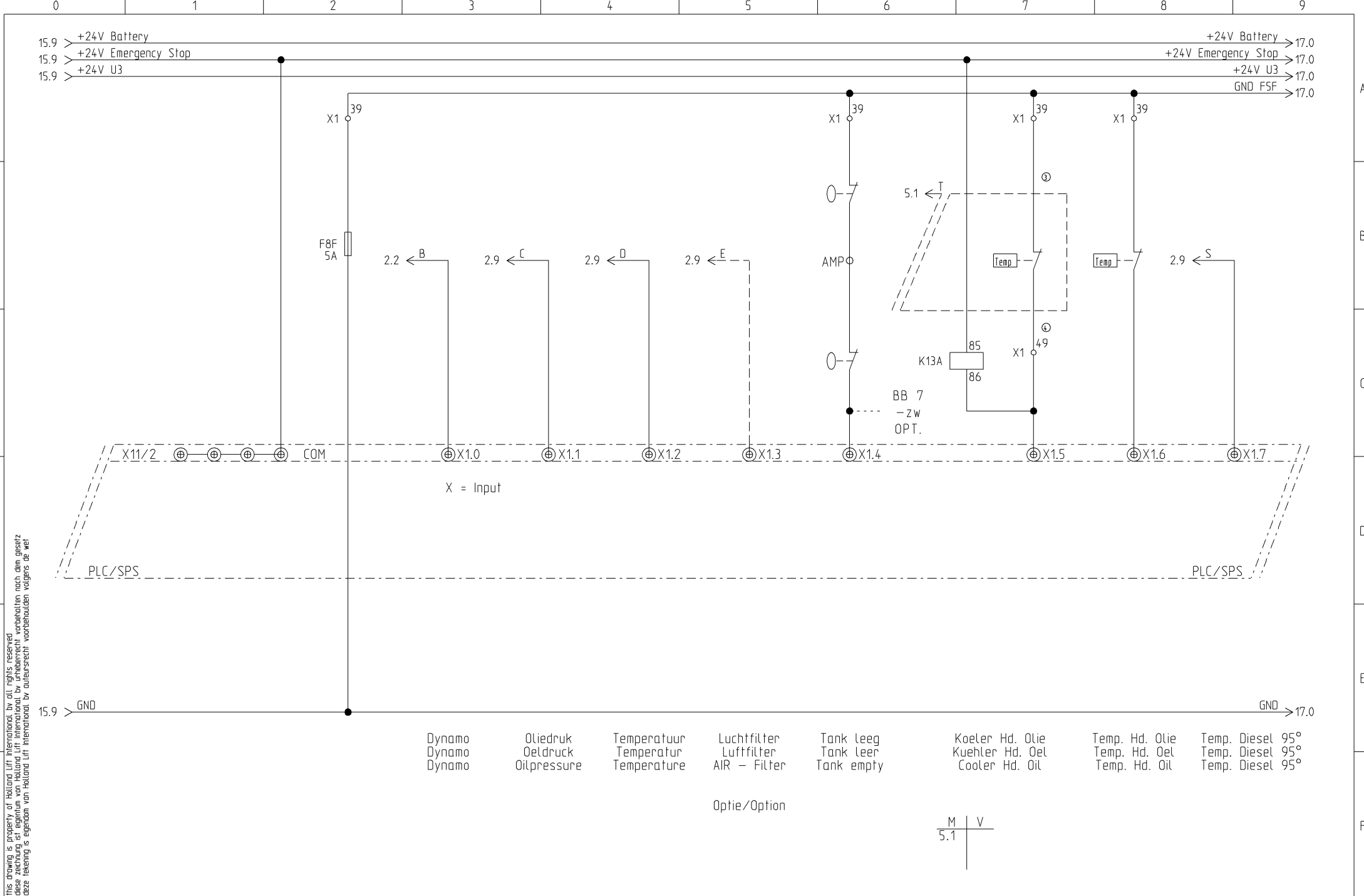

- Dynamo
 - Olgedruk
 - Temperatuur
 - Luchtfilter
 - Tank leeg
 - Koeler Hd. Olie
 - Temp. Hd. Olie
 - Temp. Diesel 95°
- Dynamo
 - Oelddruk
 - Temperatur
 - Luffilter
 - Tank leer
 - Kuehler Hd. Oel
 - Temp. Hd. Oel
 - Temp. Diesel 95°
- Dynamo
 - Oilpressure
 - Temperature
 - AIR - Filter
 - Tank empty
 - Cooler Hd. Oil
 - Temp. Hd. Oil
 - Temp. Diesel 95°

Optie/Option

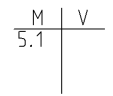

Holland Lift International B.V.
 Anodeweg 1
 NL-1627 LJ Hoorn The Netherlands
 T/F +31 (0)229-285555 / 285550
 E service@hollandlift.com
 W www.hollandlift.com

STROOMKRINGSCHEMA
 STROMLAUFPLAN
 CIRCUIT DIAGRAM

Projekt:	EM-21-001	Zeichnungsnummer:	Rev.:	erstellt von: Rothenbusch
Datum:	24.11.2014	Anlage:	Ort:	Blatt: 16

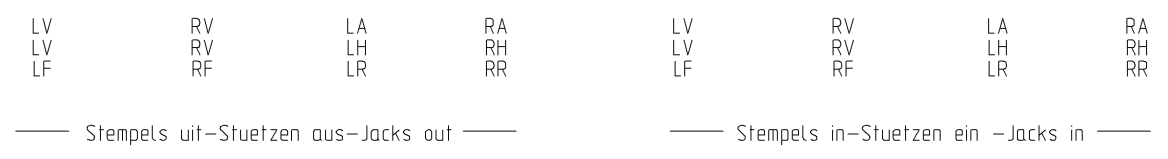
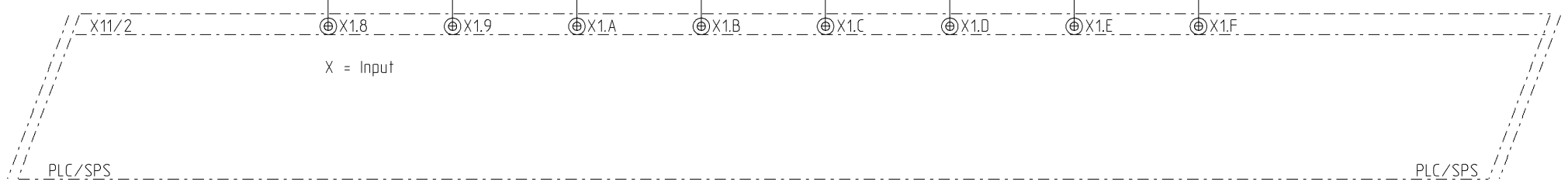
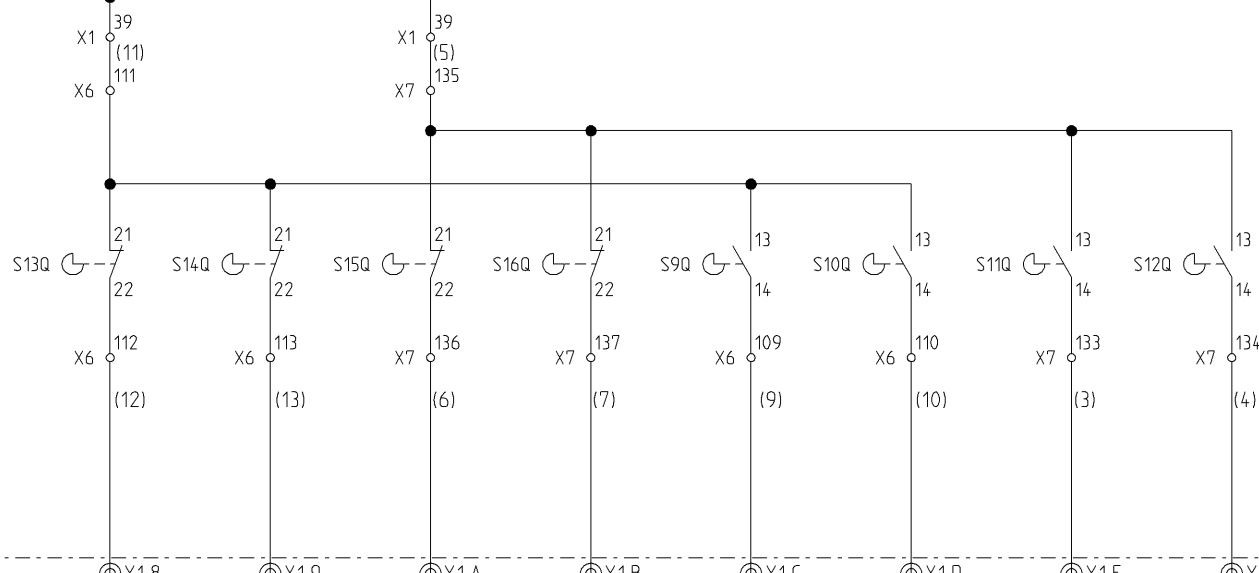
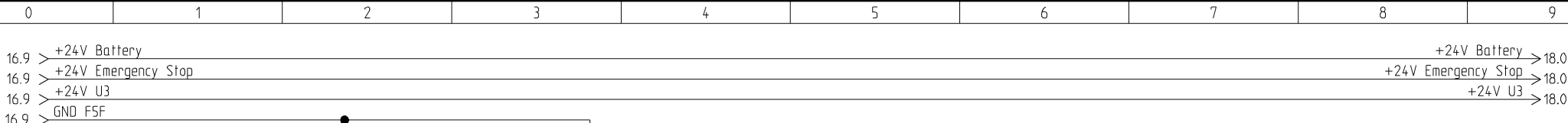

this drawing is property of Holland Lift International, by all rights reserved
 deze tekening is eigendom van Holland Lift International, by all rights reserved
 deze tekening is eigendom van Holland Lift International, by all rights reserved



Holland Lift International B.V.
 Anodeweg 1
 NL-1627 LJ Hoorn The Netherlands
 T/F +31 (0)229-285555 / 285550
 E service@hollandlift.com
 W www.hollandlift.com

STROOMKRINGSCHMA
 STROMLAUFPLAN
 CIRCUIT DIAGRAM

Projekt:	EM-21-001	Zeichnungsnummer:	Rev.:	erstellt von:
Datum:	24.11.2014	Anlage:	Ort:	Rothenbusch
		=	+	Blatt: 17

This drawing is property of Holland Lift International. By all rights reserved.
 deze tekening is eigendom van Holland Lift International. By auteursrecht voorbehouden volgens de wet.

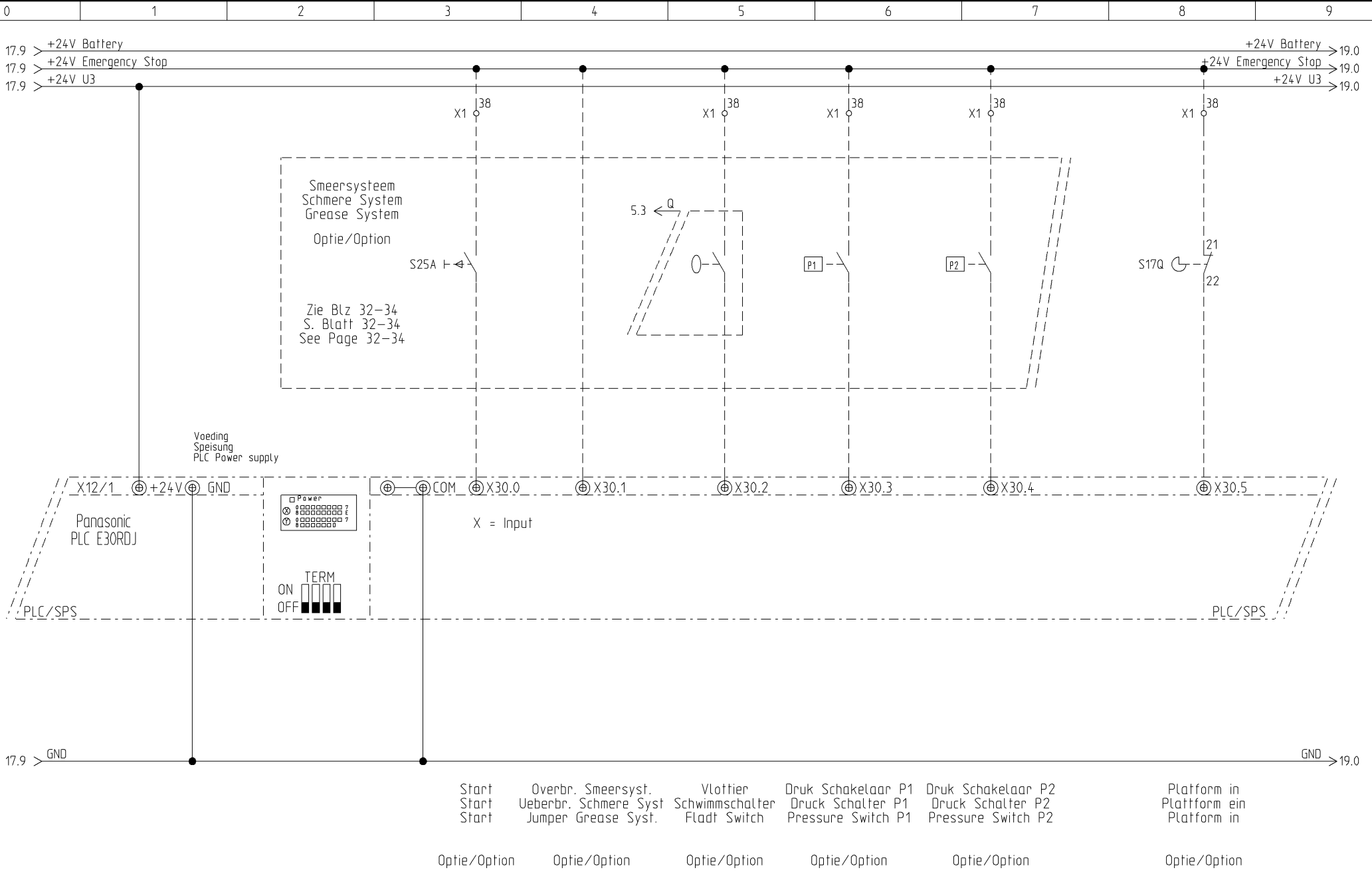

this drawing is property of Holland Lift International, by all rights reserved.
 deze tekening is eigendom van Holland Lift International, by all rights reserved.
 deze tekening is eigendom van Holland Lift International, by all rights reserved.

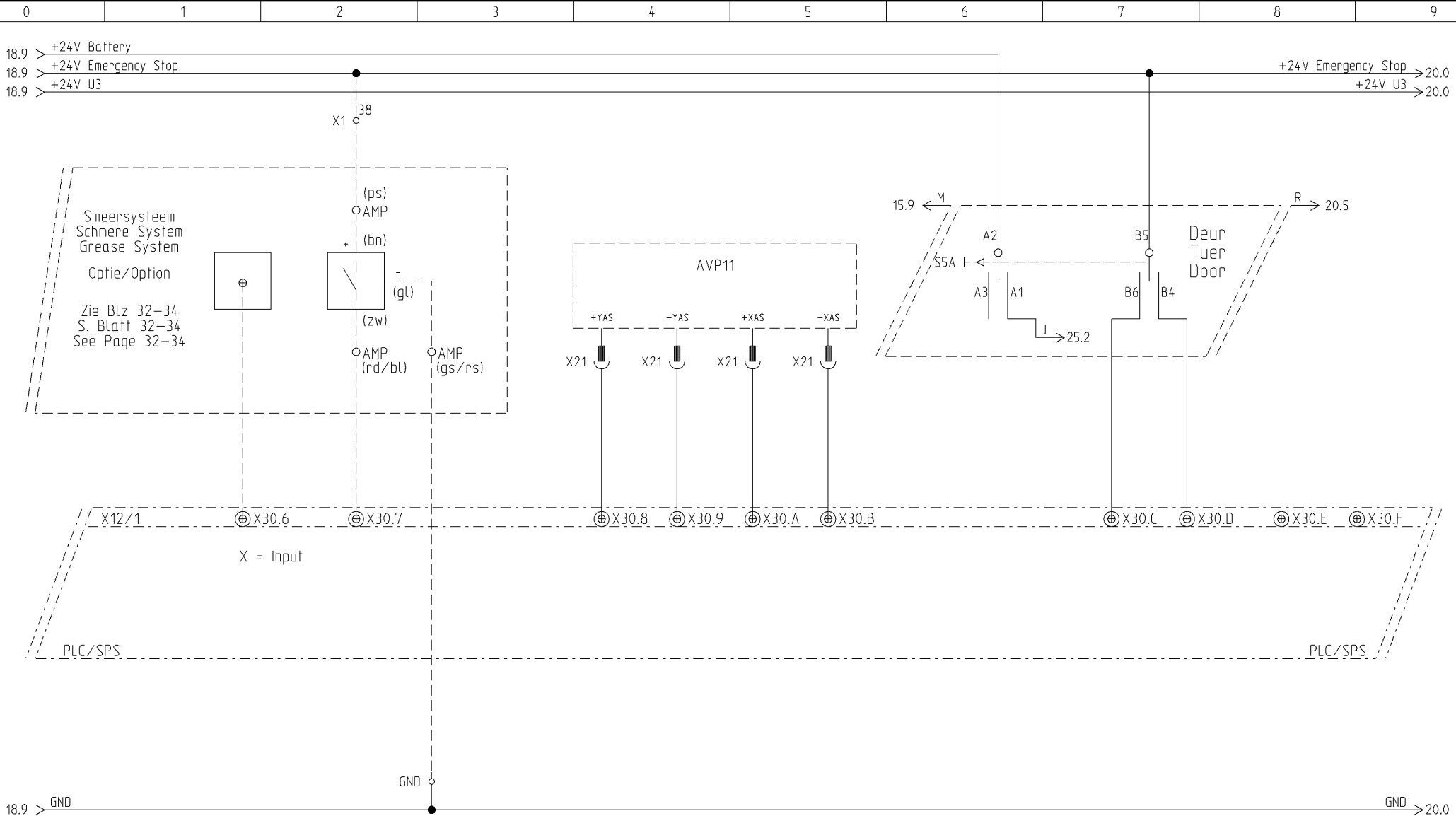

Hli Test Smeersyst.
Hli Test Schmere Syst.
Hli Test Grease Syst.

Sensor laatste Smeerpunt
Sensor Letzter Schmierpunkt
Sensor Last Grease Point

Autom. Waterpas
Autom. Horizontal
Autom. Level

Heffen – Dalem
Heben – Senken
Lift Up – Lift Down

Reserve
Reserve
Spare

Reserve
Reserve
Spare

Optie/Option

Optie/Option

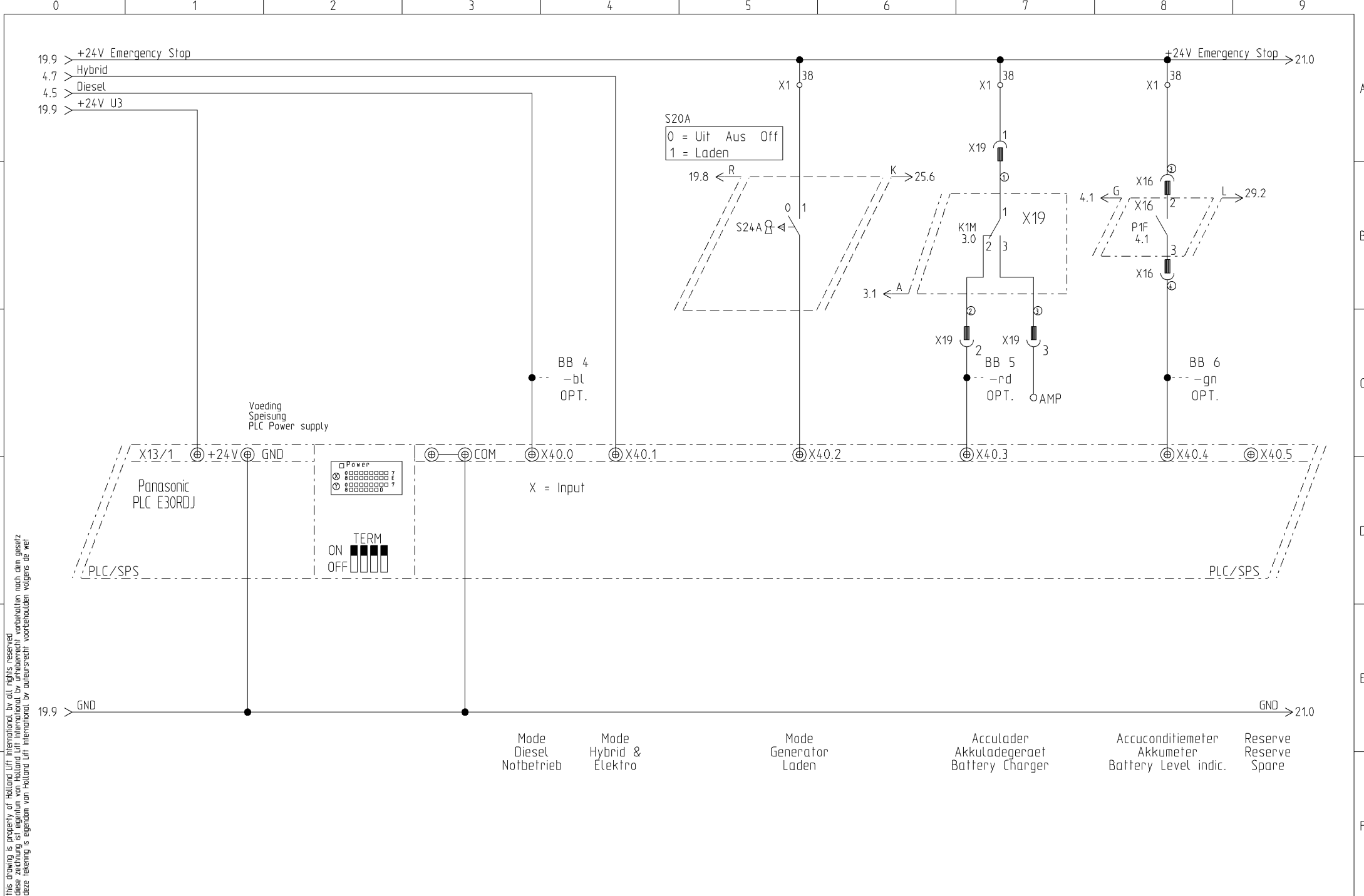

this drawing is property of Holland Lift International, by all rights reserved
 deze tekening is eigendom van Holland Lift International, by auteursrecht voorbehouden volgens de wet
 deze tekening is eigendom van Holland Lift International, by auteursrecht voorbehouden volgens de wet



this drawing is property of Holland Lift International B.V. all rights reserved
 deze tekening is eigendom van Holland Lift International B.V. alle rechten voorbehouden
 deze tekening is eigendom van Holland Lift International B.V. alle rechten voorbehouden volgens de wet



Holland Lift International B.V.
 Anodeweg 1
 NL-1627 LJ Hoorn The Netherlands
 T/F +31 (0)229-285555 / 285550
 E service@hollandlift.com
 W www.hollandlift.com

STROOMKRINGSHEMA
 STROMLAUFPLAN
 CIRCUIT DIAGRAM

Projekt: EM-21-001
 Datum: 24.11.2014

Zeichnungsnummer:
 Anlage: =

Rev.:
 Ort: +

erstellt von: Rothenbusch
 Blatt: 21

this drawing is property of Holland Lift International, by all rights reserved
 deze tekening is eigendom van Holland Lift International, by auteursrecht voorbehouden volgens de wet

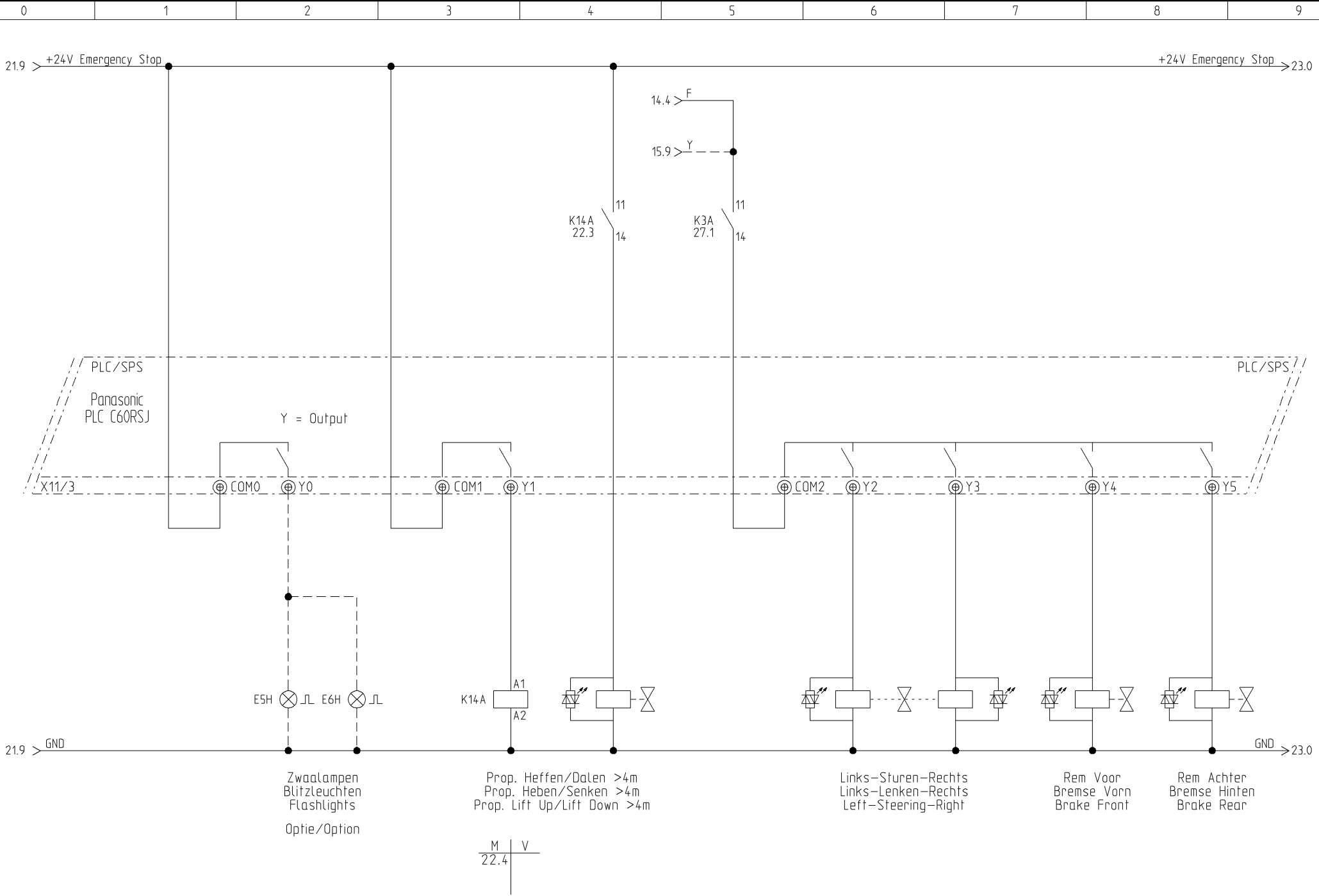

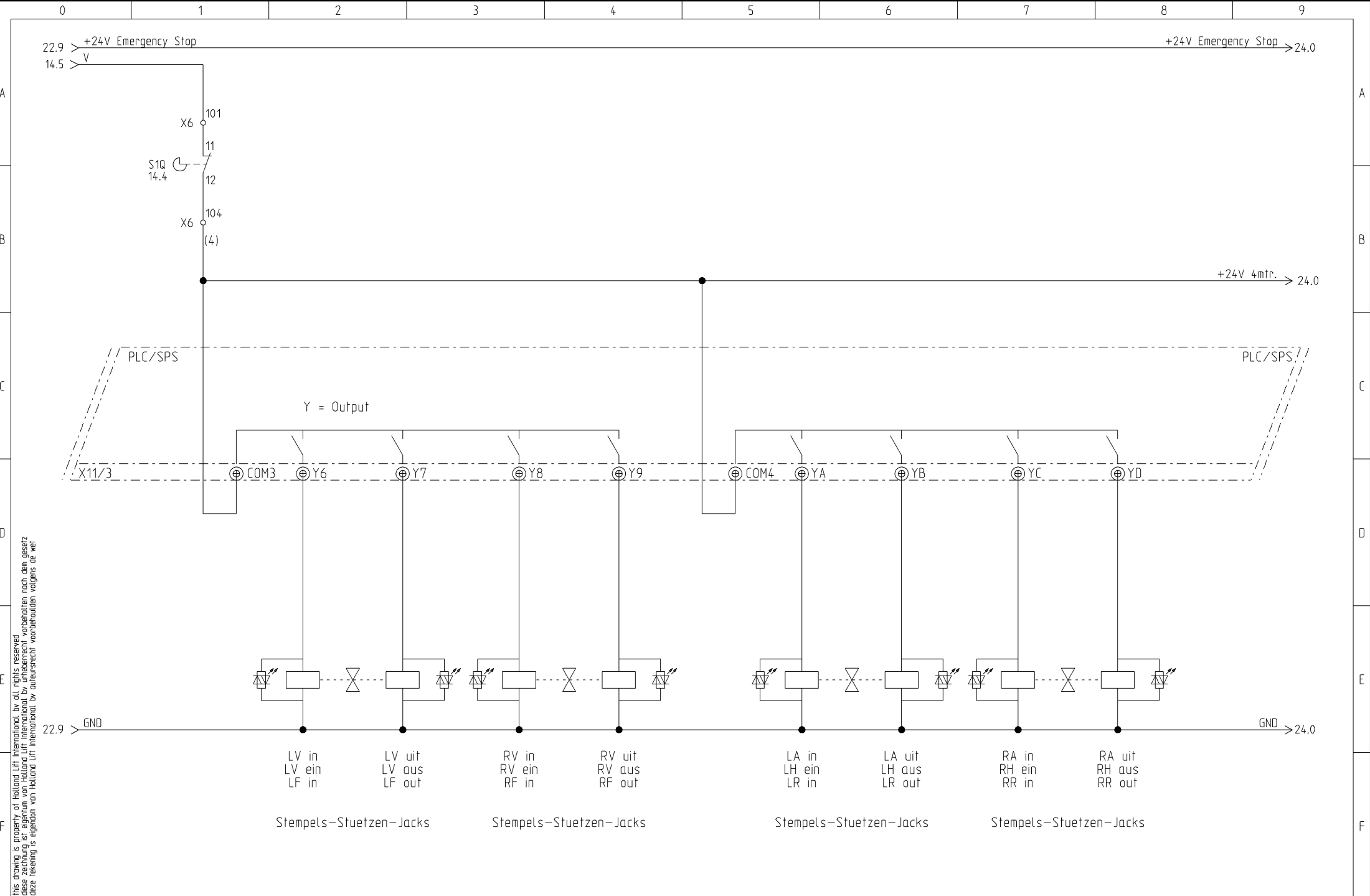

this drawing is property of Holland Lift International, by all rights reserved.
 deze tekening is eigendom van Holland Lift International, by all rights reserved.
 deze tekening is eigendom van Holland Lift International, by all rights reserved.



Holland Lift International B.V.
 Anodeweg 1
 NL-1627 LJ Hoorn The Netherlands
 T/F +31 (0)229-285555 / 285550
 E service@hollandlift.com
 W www.hollandlift.com

STROOMKRINGSCHEMA
 STROMLAUFPLAN
 CIRCUIT DIAGRAM

Projekt:	EM-21-001	Zeichnungsnummer:	Rev.:	erstellt von:
Datum:	24.11.2014	Antlage:	Ort:	Rothenbusch
		=	+	Blatt: 23

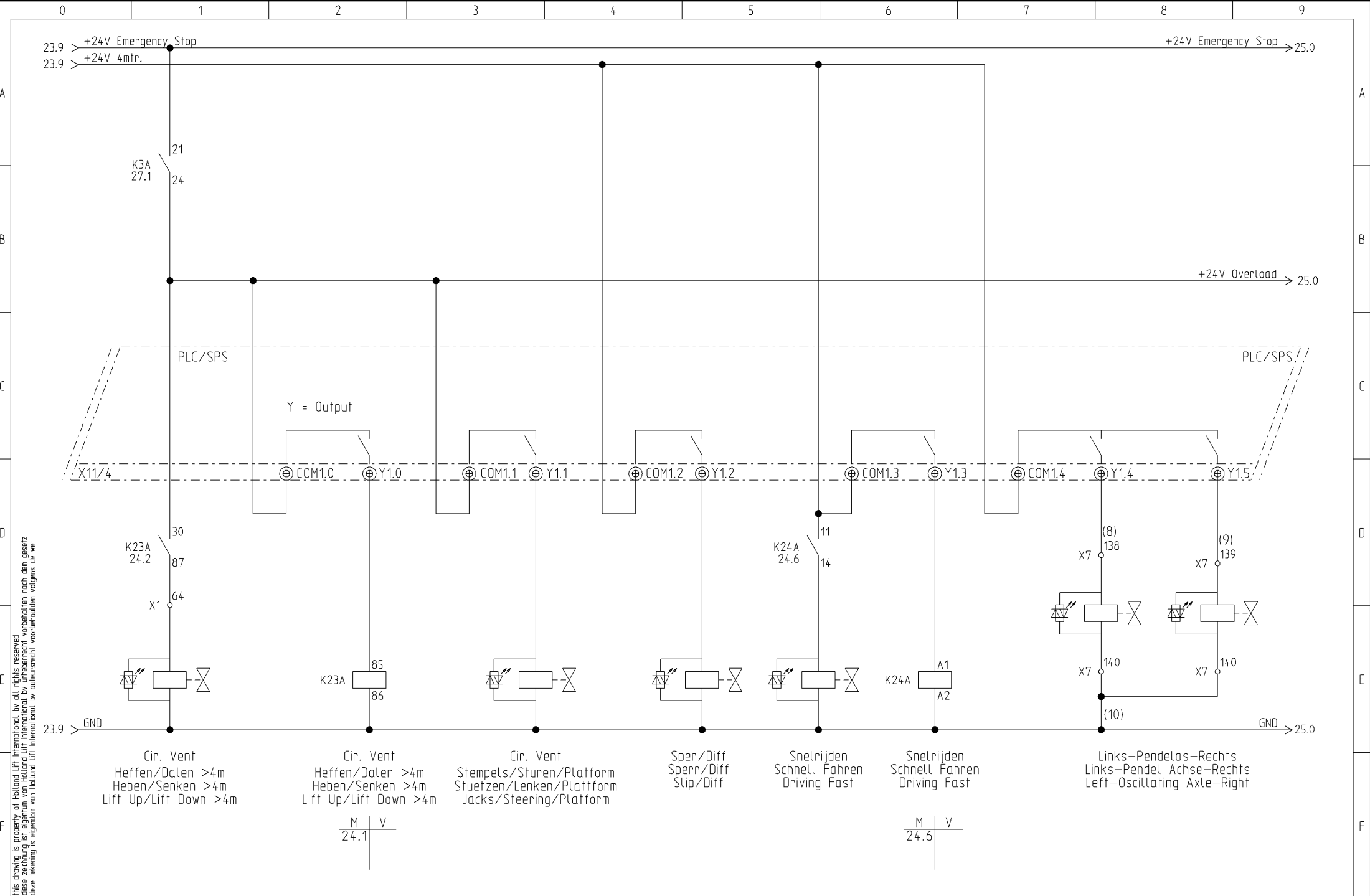

this drawing is property of Holland Lift International, by all rights reserved
 deze tekening is eigendom van Holland Lift International, by auteursrecht voorbehouden volgens de wet
 deze tekening is eigendom van Holland Lift International, by auteursrecht voorbehouden volgens de wet



Holland Lift International B.V.
 Anodeweg 1
 NL-1627 LJ Hoorn The Netherlands
 T/F +31 (0)229-285555 / 285550
 E service@hollandlift.com
 W www.hollandlift.com

STROOMKRINGSCHEMA
 STROMLAUFPLAN
 CIRCUIT DIAGRAM

Projekt:	EM-21-001	Zeichnungsnummer:	Rev.:	erstellt von:
Datum:	24.11.2014	Anlage:	Ort:	Rothenbusch
		=	+	Blatt: 24

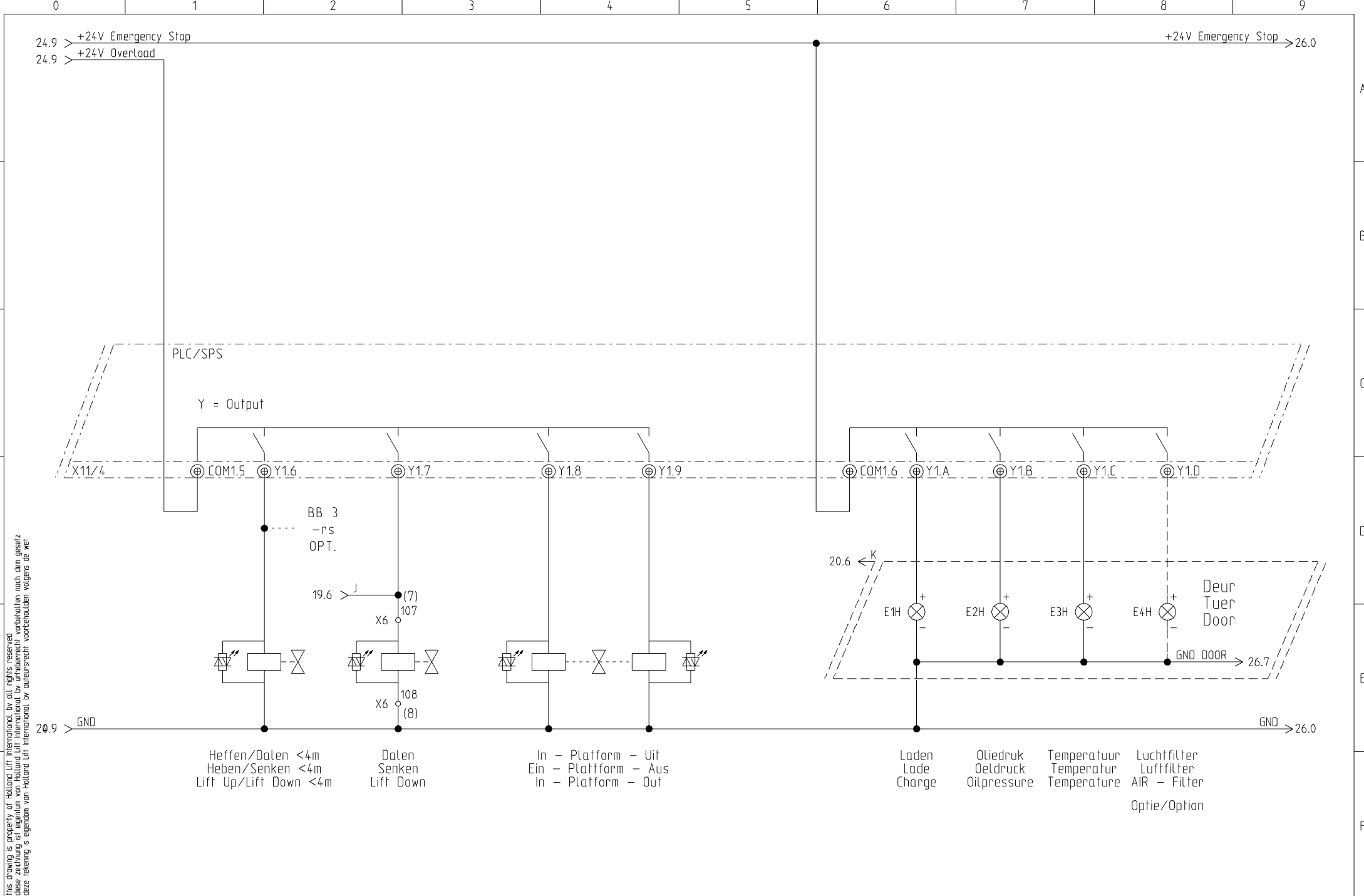

this drawing is property of Holland Lift International, by all rights reserved
 deze tekening is eigendom van Holland Lift International, by all rights reserved
 deze tekening is eigendom van Holland Lift International, by all rights reserved



Holland Lift International B.V.
 Anodeweg 1
 NL-1627 LJ Hoorn The Netherlands
 T/F +31 (0)229-285555 / 285550
 E service@hollandlift.com
 W www.hollandlift.com

STROOMKRINGSCHEMA
 STROMLAUFPLAN
 CIRCUIT DIAGRAM

Projekt:	EM-21-001	Zeichnungsnummer:	Rev.:	erstellt von:
Datum:	24.11.2014	Anlage:	Ort:	Rothenbusch
		=	+	Blatt: 25

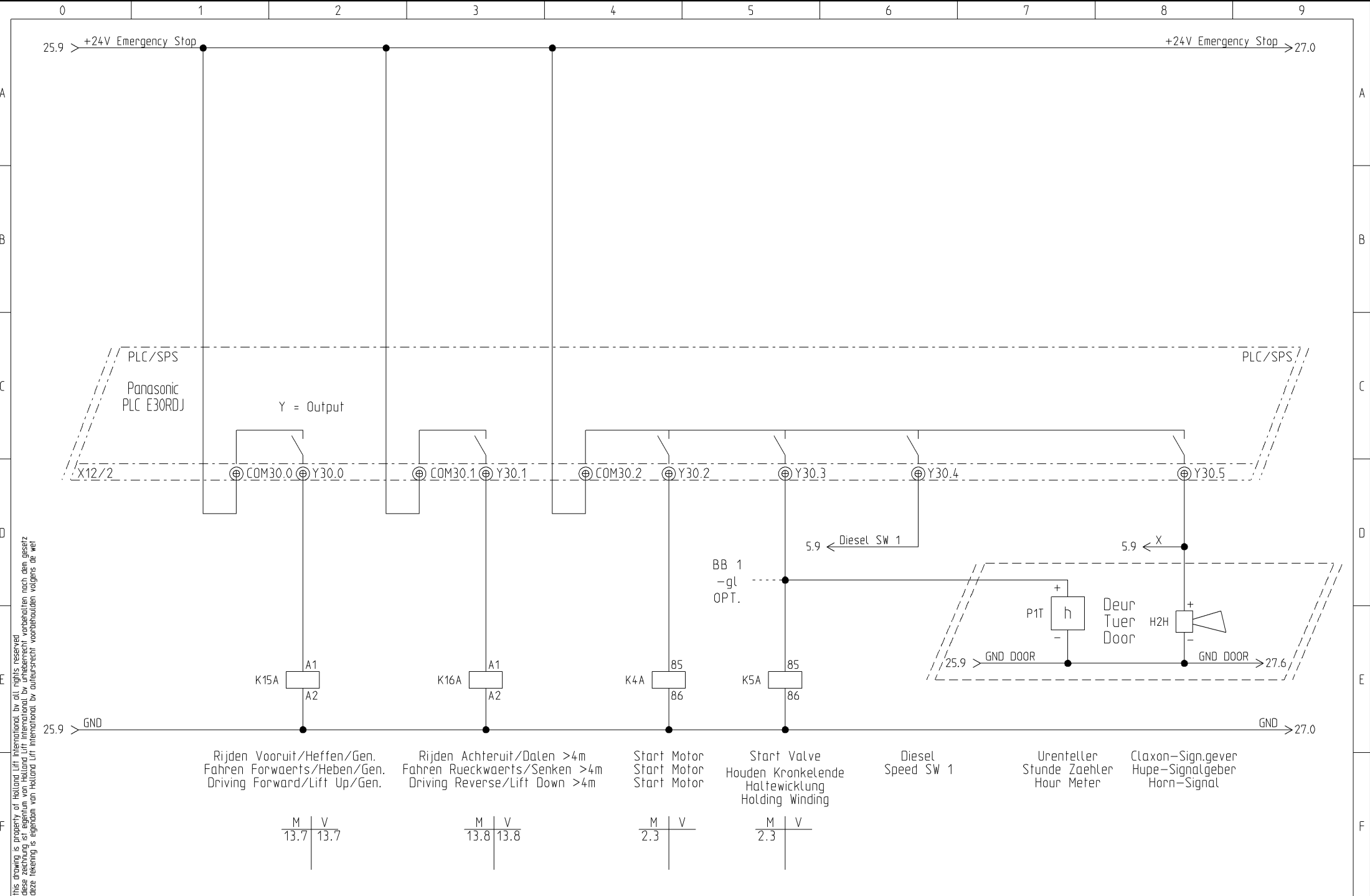

this drawing is property of Holland Lift International, by all rights reserved.
 diese zeichnung ist eigentum von Holland Lift International, by urheberrecht vorbehalten nach dem gesetz
 deze tekening is eigendom van Holland Lift International, by auteursrecht voorbehouden volgens de wet

This drawing is property of Holland Lift International. By all rights reserved.
 deze tekening is eigendom van Holland Lift International. By auteursrecht voorbehouden volgens de wet.

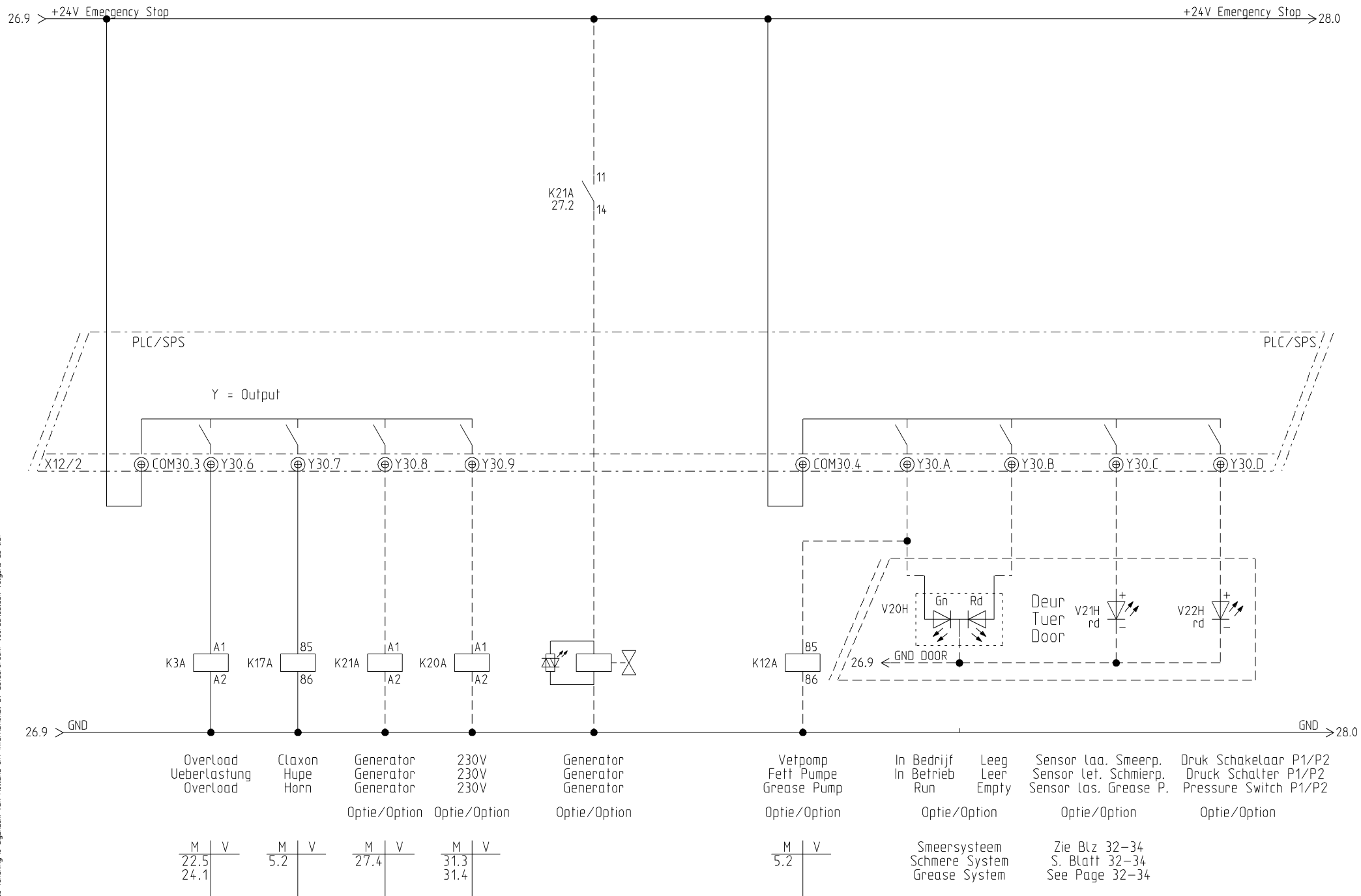

Holland Lift International B.V.
 Anodeweg 1
 NL-1627 LJ Hoorn The Netherlands
 T/F +31 (0)229-285555 / 285550
 E service@hollandlift.com
 W www.hollandlift.com

STROOMKRINGSCHEMA
 STROMLAUFPLAN
 CIRCUIT DIAGRAM

Projekt:	EM-21-001	Zeichnungsnummer:	Rev.:	erstellt von:
Datum:	24.11.2014	Anlage:	Ort:	Rothenbusch
				Blatt:
				27

this drawing is property of Holland Lift International. By all rights reserved.
 deze tekening is eigendom van Holland Lift International. By auteursrecht voorbehouden volgens de wet.
 deze tekening is eigendom van Holland Lift International. By auteursrecht voorbehouden volgens de wet.

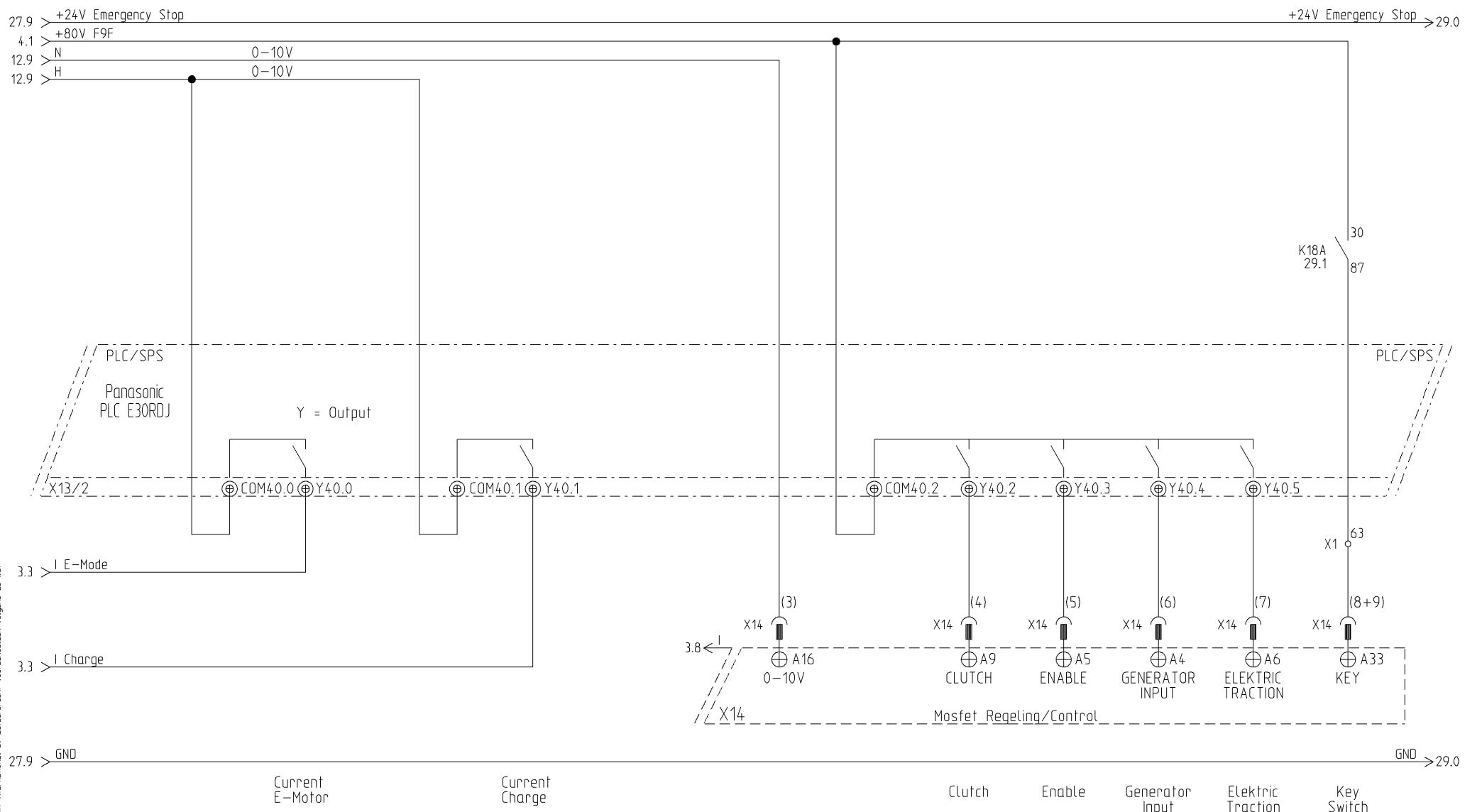

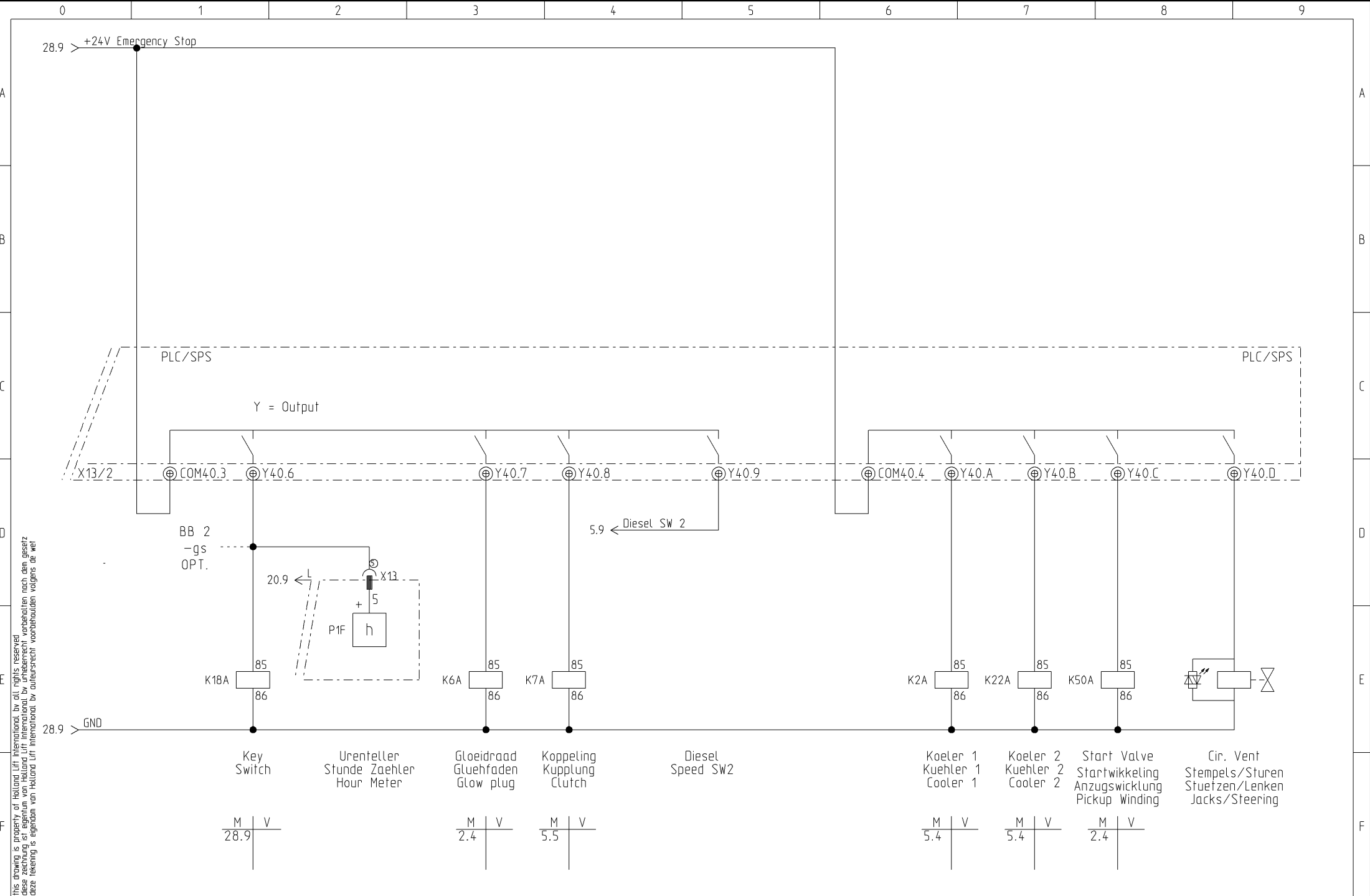

this drawing is property of Holland Lift International, by all rights reserved
 deze tekening is eigendom van Holland Lift International, by all rights reserved
 deze tekening is eigendom van Holland Lift International, by all rights reserved

OPTIES
OPTIONEN
OPTIONS

(HLI)

OPTIE BLACK-BOX MINI DAT
OPTION BLACK-BOX MINI DAT
OPTION BLACK-BOX MINI DAT

BB-wt	+24V DC	+24V DC	+24V DC	+24V DC
BB-bn	GND	GND	GND	GND
BB-gl	CH1	DIESEL AAN	DIESEL EIN	DIESEL ON
BB-gs	CH2	E-MOTOR AAN	E-MOTOR EIN	E-MOTOR ON
BB-rs	CH3	HEFFEN	HEBEN	LIFT UP
BB-bl	CH4	DIESEL NOT	DIESEL NOT	DIESEL NOT
BB-rd	CH5	LAADTIJD	LADEZEIT	CHARGE TIME
BB-gn	CH6	ACCU LEEG	AKKU LEER	BATTERY EMPTY
BB-zw	CH7	TANK LEEG	TANK LEER	TANK EMPTY
BB-vi	CH8	RESERVE	RESERVE	RESERVE

BELANGRIJK/WICHTIG/IMPORTANT

BIJ TOEPASSING BLACK-BOX
BEI BLACK-BOX
WHEN BLACK-BOX IS USED

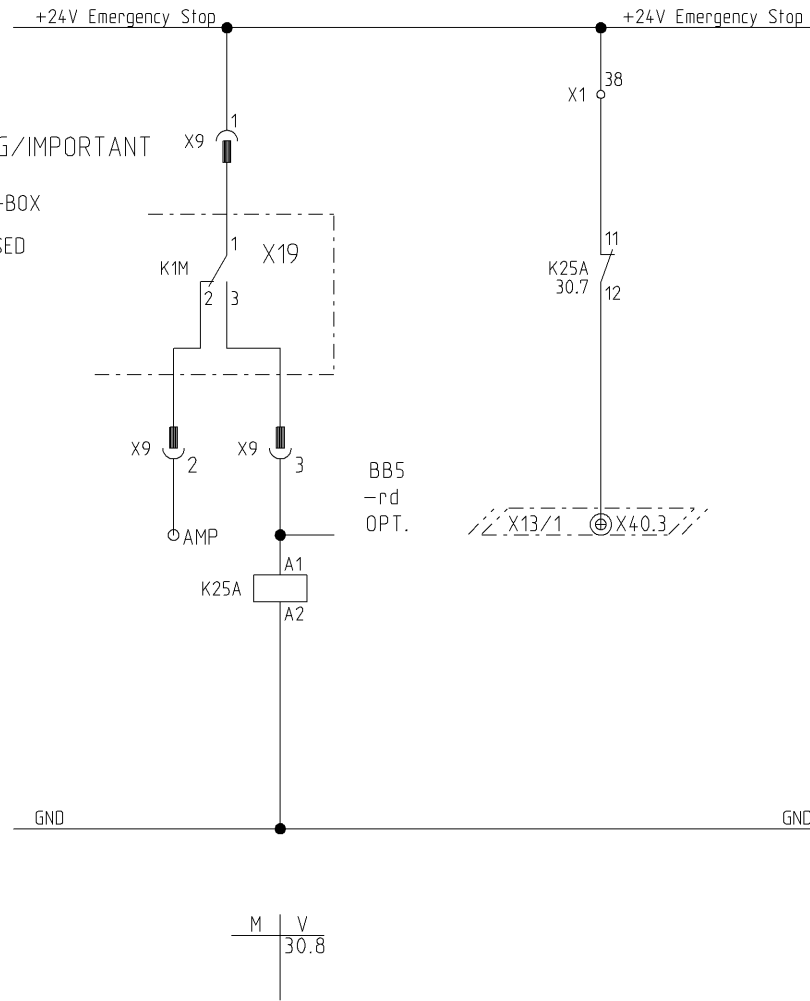

this drawing is property of Holland Lift International, by all rights reserved
 diese zeichnung ist eigentum von Holland Lift International, by urheberrecht vorbehalten
 deze tekening is eigendom van Holland Lift International, by auteursrecht voorbehouden volgens de wet

OPTIES
OPTIONEN
OPTIONS

230V AANSLUITING PLATFORM
230V ANSCHLUSS PLATTFORM
230V SUPPLY PLATFORM

<230VPLF>

230V-50Hz/115V-50Hz

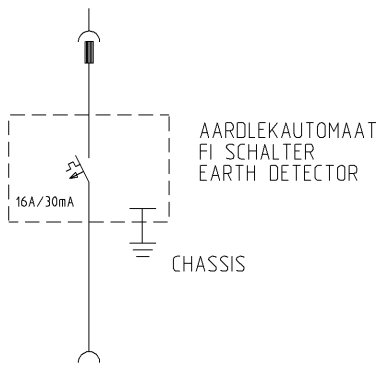

230V AANSLUITING PLATFORM
230V ANSCHLUSS PLATTFORM
230V SUPPLY PLATFORM

<230V-GEN>

230V-50Hz/115V-50Hz

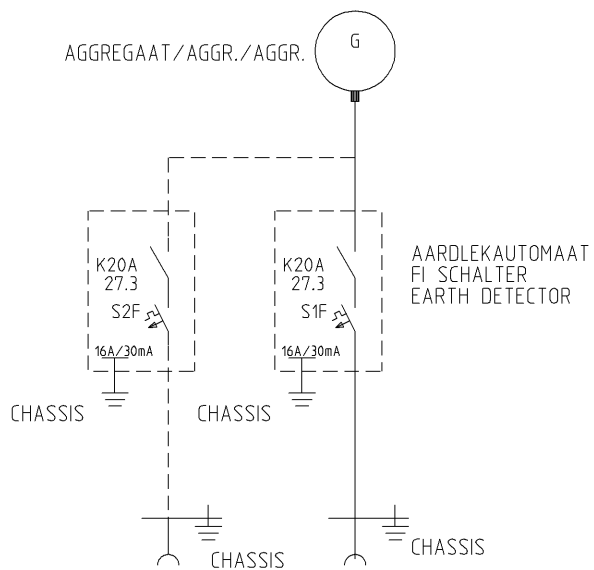

2e HOOGTE AFLSAG
2e HOEHE AUSSCHALTUNG
2nd HEIGHT CUT-OUT

<2HA>

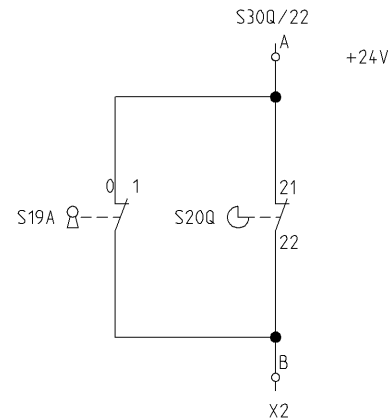

Zie Blz 14
S. Blatt 14
See Page 14

S19A

0 = Max. Hoogte/Max. Hoehe/Max. Height
1 = 2e HOOGTE AFL./2e H. AUSS./2nd H. CUT-OUT

this drawing is property of Holland Lift International, by all rights reserved
 diese zeichnung ist eigentum von Holland Lift International, by urheberrecht vorbehalten nach dem gesetz
 deze tekening is eigendom van Holland Lift International, by auteursrecht voorbehouden volgens de wet

OPTIES OPTIONEN OPTIONS

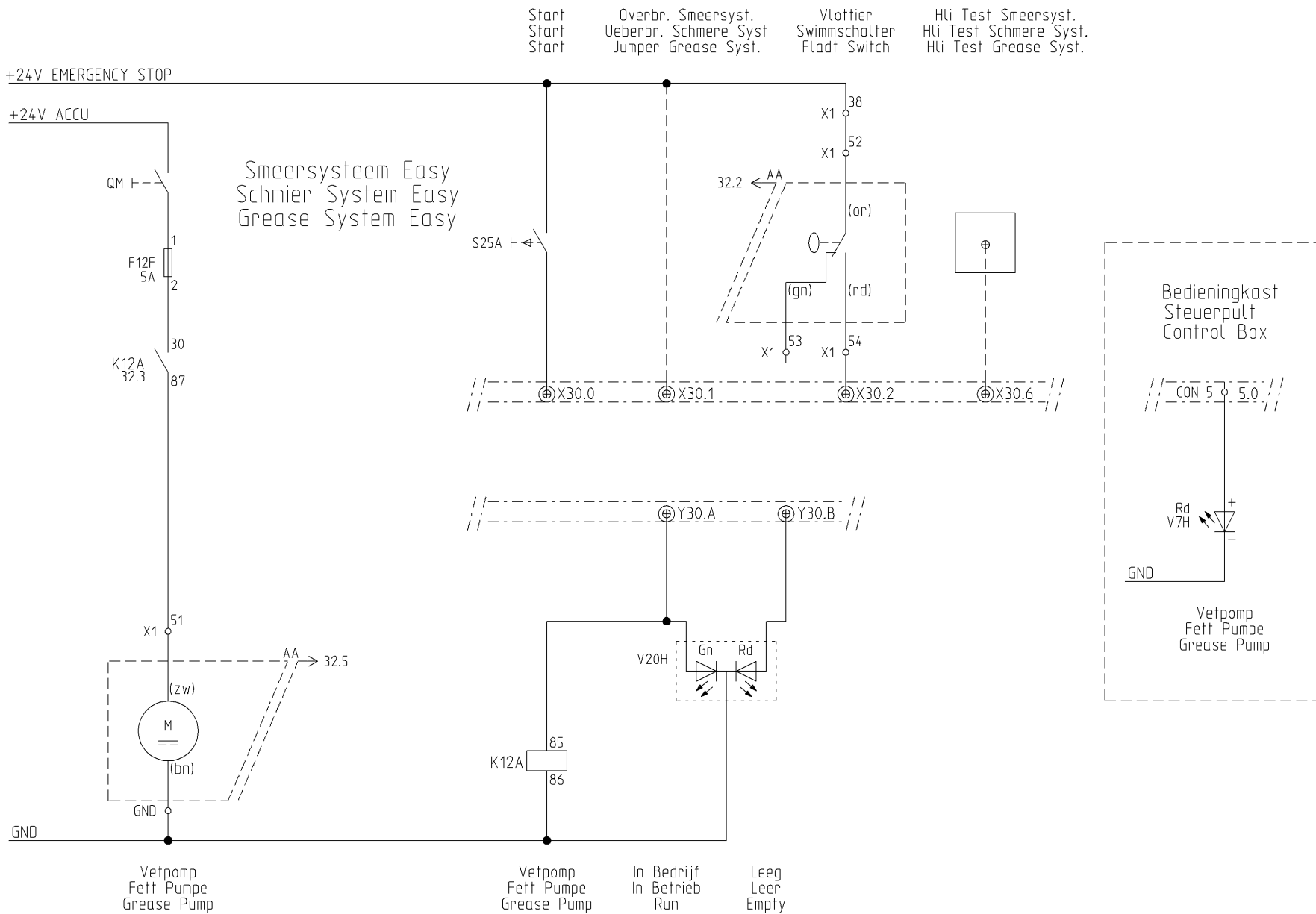

this drawing is property of Holland Lift International, by all rights reserved
 diese zeichnung ist eigentum von Holland Lift International, by urheberrecht vorbehalten nach dem gesetz
 deze tekening is eigendom van Holland Lift International, by auteursrecht voorbehouden volgens de wet

OPTIES OPTIONEN OPTIONS

Start Overbr. Smeersyst. Vlottier Onderwagen P1 Schaar P2 Hli Test Smeersyst. Sensor laatste Smeerpunt
 Start Ueberbr. Schmere Syst. Swimmerschalter Chassis P1 Schere P2 Hli Test Schmere Syst. Sensor letzter Schmierpunkt
 Start Jumper Grease Syst. Fladt Switch Chassis P1 Scissor P2 Hli Test Grease Syst. Sensor Last Grease Point

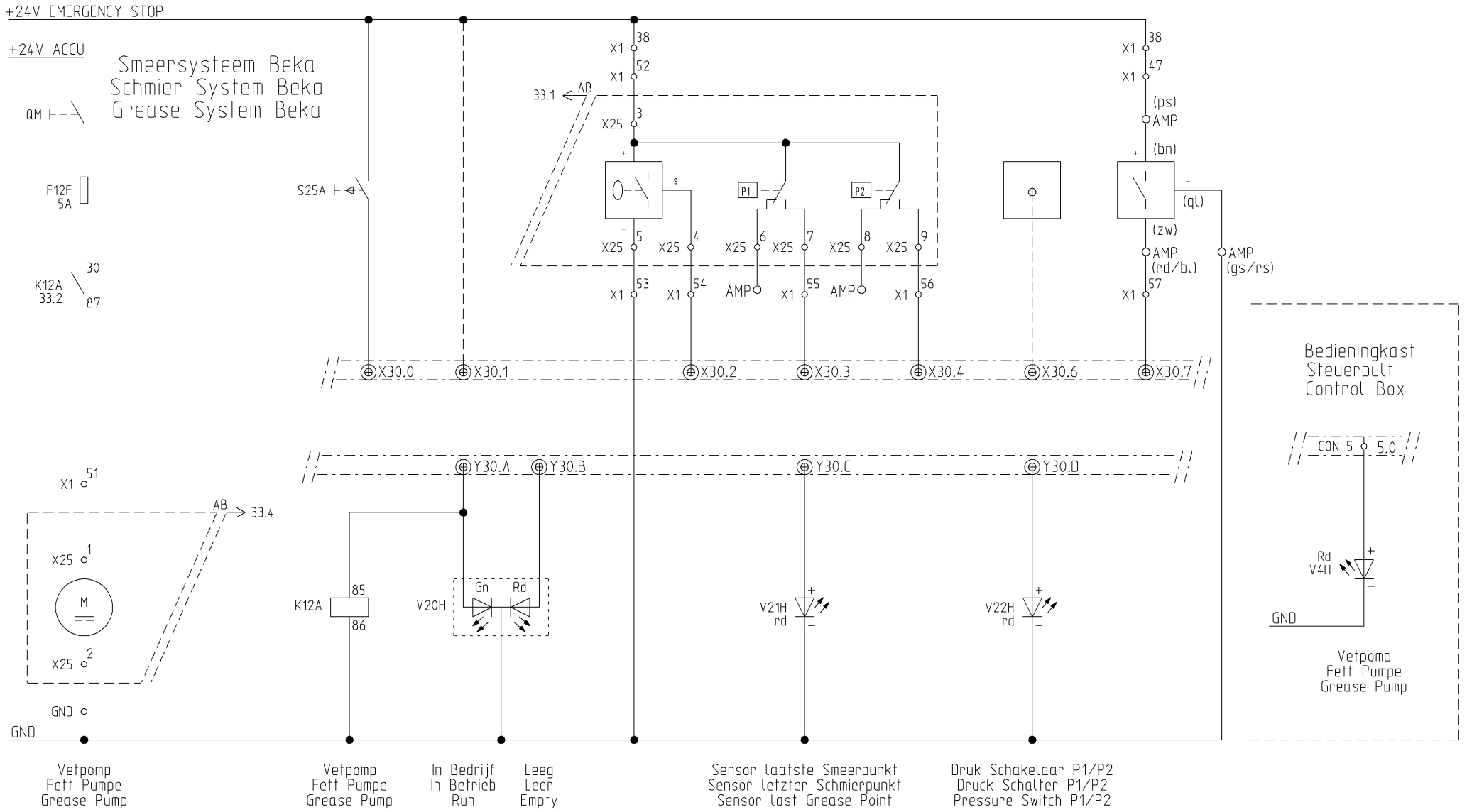

this drawing is property of Holland Lift International, by all rights reserved
 deze tekening is eigendom van Holland Lift International, by all rights reserved
 deze tekening is eigendom van Holland Lift International, by all rights reserved



Holland Lift International B.V.
 Anodeweg 1
 NL-1627 LJ Hoorn The Netherlands
 T/F +31 (0)229-285555 / 285550
 E service@hollandlift.com
 W www.hollandlift.com

OPTIES
 OPTIONEN
 OPTIONS

Projekt: EM-21-001	Zeichnungsnummer:	Rev.:	erstellt von: Rothenbusch
Datum: 24.11.2014	Anlage: =	Ort: +	Blatt: 33

OPTIES OPTIONEN OPTIONS

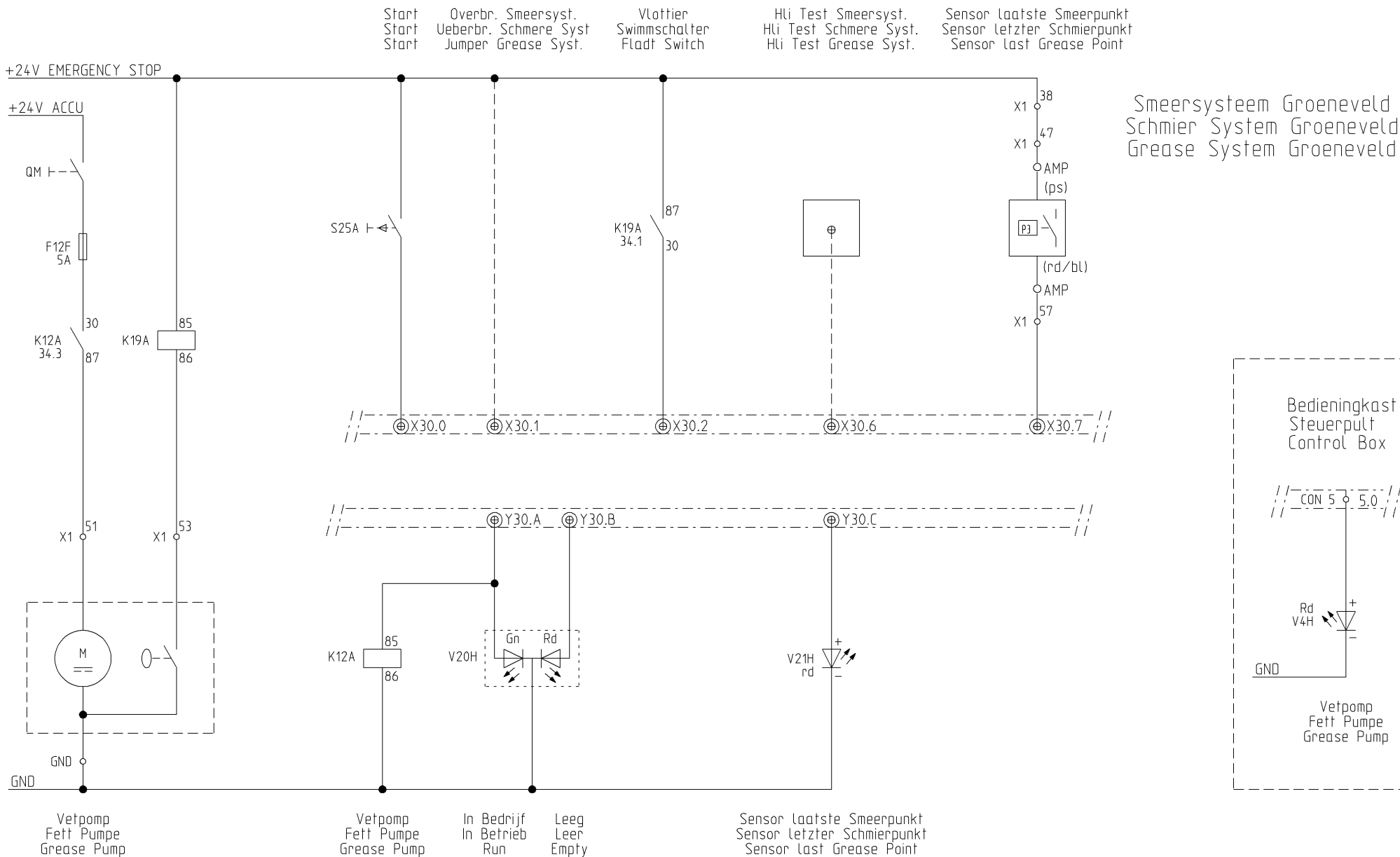

this drawing is property of Holland Lift International. By all rights reserved.
 deze tekening is eigendom van Holland Lift International. By auteursrecht voorbehouden volgens de wet.
 diese Zeichnung ist Eigentum von Holland Lift International. By Urheberrecht vorbehalten nach dem Gesetz.

KLEMMENKAST

KLEMMENKASTEN

CONNECTION BOX

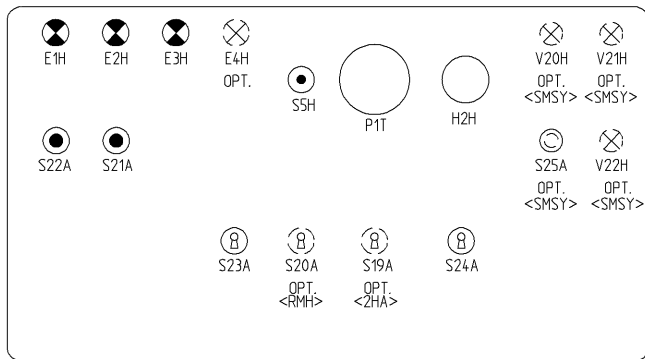

OPT.
<SMSY>

54			54
53	57	57	53
52	56	56	52
51	55	55	51
	F7F	5A/7.5A	

49			49
48	64	64	48
47	63	63	47
46	62	62	46
45	61	61	45
44	60	60	44
43	59	59	43
42	58	58	42
41	50	50	41
39	39	39	39
38	38	38	38
38	38	38	38
38	38	38	38
37	37	37	37
33	36	36	33
32	35	35	32
31	34	34	31

Colour schedule			
Colour	Dutch	English	Deutsch
Rd	Rood	Red	Rot
Bl	Blauw	Blue	Blau
Gt	Geel	Yellow	Gelb
Gr	Groen	Green	Gruen
Zw	Zwart	Black	Schwarz
Wt	Wit	White	Weiss
Bn	Bruin	Brown	Braun
Rs	Roze	Pink	Rosa
Or	Oranje	Orange	Orange
Ps	Paars	Violet	Violett
Tp	Transp.	Transp.	Transp.
Gs	Grijs	Grey	Grau

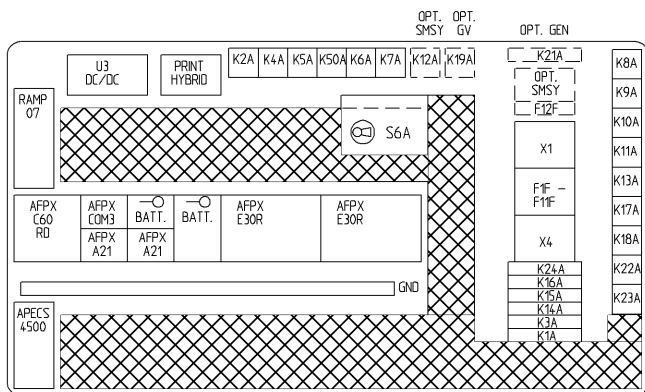

X1

	F11F	7.5A	
	F10F	10A	
	F9F	10A	
	F8F	5A	
	F7F	5A	
	F6F	5A	
	F5F	20A	
	F4F	20A	
	F3F	20A	
	F2F	20A	
	F1F	20A	
9	17	17	9
8	16	16	8
7	15	15	7
6	14	14	6
5	13	13	5
4	12	12	4
3	11	11	3
2	10	10	2

AANSluiting OP PLATFORM
ANSchluss AUf PLATTFORM
CONNECTION ON PLATFORM

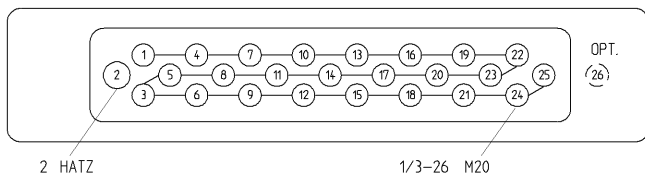

X4

	20	20	
	19	19	
	18	18	
	1	1	

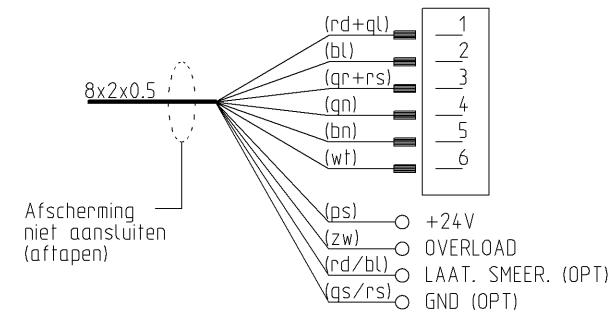

this drawing is property of Holland Lift International, by all rights reserved.
 deze tekening is eigendom van Holland Lift International, by all rights reserved.
 deze tekening is eigendom van Holland Lift International, by all rights reserved.

KLEMMENKAST KLEMMENKASTEN CONNECTION BOX

WARTEL KABELINF. GLAND NR.	KLEMME TERMINAL NR	FUNKTIE	FUNKTION	FUNCTION
1.1	φ 18	+24V Diesel	+24V Diesel	+24V Diesel
1.2	GND	GND Diesel	GND Diesel	GND Diesel
1.3	φ 1	+ Generator	+ Generator	+ Generator
2	DIV/VAR	Diesel X5	Diesel X5	Diesel X5
3.1	φ 38-GND-X7	Scheefstand	Neigung	Inclination
3.2	DIV/VAR	Auto Niv.	Auto Niv.	Auto Niv.
3.3	φ 38-GND-X8	Scheefstand Opt.	Neigung Opt.	Inclination Opt.
4.1	DIV/VAR	Koeler	Kuehler	Cooler
4.2	YA-GND	Stempels LA in	Stuetzen LH ein	Jacks LR in
4.3	YB-GND	Stempels LA uit	Stuetzen LH aus	Jacks LR out
5.1	YC-GND	Stempels RA in	Stuetzen RH ein	Jacks RR in
5.2	YD-GND	Stempels RA uit	Stuetzen RH aus	Jacks RR out
5.3	YE-GND	Stempels LV in	Stuetzen LV ein	Jacks LF in
6.1	Y7-GND	Stempels LV uit	Stuetzen LV aus	Jacks LF out
6.2	Y8-GND	Stempels RV in	Stuetzen RV ein	Jacks RF in
6.3	Y9-GND	Stempels RV uit	Stuetzen RV aus	Jacks RF out
7	DIV/VAR	Lasdoos voor X6	Verdeelersdoos vora X6	Connect. Box front X6
8	DIV/VAR	Lasdoos achter X7	Verdeelersdoos hinda X7	Connect. Box rear X7
9.1	Y1.2-GND	Sper/Diff. Ventiel	Sperr/Diff. Ventil	Stip/Diff. Valve
9.2	K24A:14-GND	Snelrijden	Schnell Fahren	Driving Fast
9.3	Y1.1-GND	Cir. Ve. Stu.-Pla.-Ste.	Cir. Ve. Len.-Pla.-Stu.	Cir. Va. Ste.-Pla.-Jac.
10.1	Y1.6-GND	Heffen/Dalen <4m	Heben/Senken <4m	Lift Up/Lift Down <4m
10.2	Y5-GND	Rem Achter	Bremse Hinten	Brake Rear
10.3	Y4-GND	Rem Voor	Bremse Vora	Brake Front
11.1	Y4.0.D-GND	Cir. Ventiel Stempels	Cir. Ventil Stuetzen	Cir. Valve Jacks
11.2	φ 64 -GND	Heffen/Dalen >4m	Heben/Senken >4m	Lift Up/Lift Down >4m
11.3	Y2-GND	Sturen Links Voor	Lenken Links Vora	Steering Left Front
12.1	Y3-GND	Sturen Rechts Voor	Lenken Rechts Vora	Steering Right Front
12.2	Y1.8-GND	Platform in	Plattform ein	Platform in
12.3	Y1.9-GND	Platform uit	Plattform aus	Platform out
13.1	φ 59 -φ 60	Prop. Ventiel A	Prop. Ventil A	Prop. Valve A
13.2	φ 61 -φ 62	Prop. Ventiel B	Prop. Ventil B	Prop. Valve B
13.3	K21A:14-GND	Hydr. Aggregaat Opt.	Hydr. Aggr. Opt.	Hydr. Aggr. Opt.

WARTEL KABELINF. GLAND NR.	KLEMME TERMINAL NR	FUNKTIE	FUNKTION	FUNCTION
14.1	DIV/VAR	RPM Teller Gen. Opt.	RPM Zaehler Gen. Opt.	RPM Meter Gen. Opt.
14.2	Y30.9-GND	Relais Aggregaat Opt.	Relais Aggr. Opt.	Relais Aggr. Opt.
14.3	K14A:14-GND	Prop. Heffen/Dalen	Prop. Heben/Senken	Prop. Lift Up/Lift Do.
15.1	φ 39 AMP	Tank leeg 1	Tank leer 1	Tank empty 1
15.2	AMP-X1.4	Tank leeg 2	Tank leer 2	Tank empty 2
15.3	φ 39 -X1.6	Temp. Hd. Olie	Temp. Hd. Oel	Temp. Hd. Oil
15.4	DIV/VAR	Frame Dieselmotor	Frame Dieselmotor	Frame Diesel Engine
16	DIV/VAR	Smeersysteem Opt.	Schmiere System Opt.	Grease System Opt.
17	DIV/VAR	WCD Onderwagen 6PM	WCD Unterwagen 6PM	Socket Below 6PM
18	DIV/VAR	WCD Platform 6PM	WCD Plattform 6PM	Socket Platform 6PM
19	DIV/VAR	Stekker Onderw. 6PF	Stecker Unterw. 6PF	Plug Below 6PF
20.1	DIV/VAR	Akkumeter	Akkumeter	Batterymeter
20.2	φ 38 -GND-Y40.0	Amperem. E-Mode	Amperem. E-Mode	Amperem. E-Mode
20.3	φ 38 -GND-Y40.1	Amperem. Laden	Amperem. Laden	Amperem. Charge
21.1	DIV/VAR	Acculader	Akkuladegeraet	Battery Charger
21.2	φ 58 -GND	Claxon	Horn	Horn
21.3	φ 17 -GND	Koppeling	Kupplung	Clutch
22	DIV/VAR	Mosfet Motorreg.	Mosfet Motorreg.	Mosfet Motor Con.
23.1	GND-φ 8	Temp. E-Motor	Temp. E-Motor	Temp. E-Motor
23.2	φ 15 -GND	Ventilator Diesel 1	Ventilator Diesel 1	Fan Diesel 1
23.3	φ 16 -GND	Ventilator Diesel 2	Ventilator Diesel 2	Fan Diesel 2
24.1 & .2	φ 20	+80V Omvormer	+80V Wandler	+80V Converter
24.3 & .4	φ 19	+24V Omvormer	+24V Wandler	+24V Converter
24.5 - .8	GND	GND Omvormer	GND Wandler	GND Converter
25.1	φ 20	+80V Electric	+80V Elektro	+80V Electric
25.2	GND	GND Electric	GND Elektro	GND Electric
25.3	DIV/VAR	Diesel X8	Diesel X8	Diesel X8
25.4	φ 38 -GND	Ventilator Mosfet	Ventilator Mosfet	Fan Mosfet
26.1	Y0-GND	Zwaaillamp Opt.	Blitzleuchte Opt.	Flashlight Opt.
26.2	Y0-GND	Zwaaillamp Opt.	Blitzleuchte Opt.	Flashlight Opt.

this drawing is property of Holland Lift International, by all rights reserved.
 diese zeichnung ist eigentum von Holland Lift International, by alle rechte vorbehalten.
 deze tekening is eigendom van Holland Lift International, by auteursrecht voorbehouden volgens de wet

HOLLAND LIFT

Holland Lift International B.V.
 Anodeweg 1
 NL-1627 LJ Hoorn The Netherlands
 T/F +31 (0)229-285555 / 285550
 E service@hollandlift.com
 W www.hollandlift.com

KASTEN/BEKABELING
 KASTEN/KABEL
 BOXES/CABLES

Projekt:	EM-21-001	Zeichnungsnummer:	Rev.:	erstellt von:
Datum:	24.11.2014	Anlage:	Ort:	Rothenbusch
		=	+	Blatt: 36

LASDOOS AFSLAGEN
VERTEILERDOSE HOEHEAUSCHALTUNG
MAXIMUM HEIGHT DISTRBUOR BOX

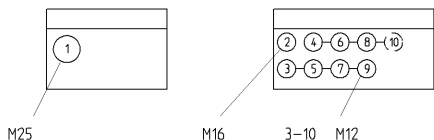
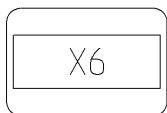

OPT.
<ZHA>

X6

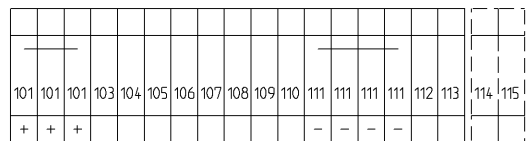

FSF

NR.	Omschrijving	Beschreibung	Descreption
1	Kabel Klemmenkast	Kabel Klemmenkasten	Cable Connection Box
2	4mtr. Afslag S1Q	4mtr. Ausschaltung S1Q	4mtr. Cut-out S1Q
3	8mtr. Afslag S2Q	8mtr. Ausschaltung S2Q	8mtr. Cut-out S2Q
4	Max. Hooqte Afslag S3Q	Max. Hoehe Ausschaltung S3Q	Max. Height Cut-out S3Q
5	Dalen	Senken	Lift Down
6	Eindschak. LV in S9Q	Endschalter LV ein S9Q	Limit Switch LF in S9Q
7	Eindschak. LV uit S13Q	Endschalter LV aus S13Q	Limit Switch LF out S13Q
8	Eindschak. RV in S10Q	Endschalter RV ein S10Q	Limit Switch RF in S10Q
9	Eindschak. RV uit S14Q	Endschalter RV aus S14Q	Limit Switch RF out S14Q
10	2e hooqte Afslag Optie	2e hoehe Ausschaltung Option	2nd height cut-out Option

LASDOOS ACHTER
VERTEILERDOSE HINTEN
DISTRBUOR BOX REAR

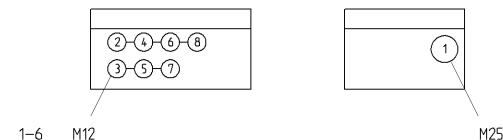
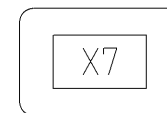

X7

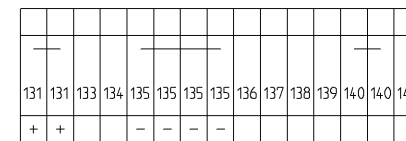

FSF

NR.	Omschrijving	Beschreibung	Descreption
1	Kabel Klemmenkast	Kabel Klemmenkasten	Cable Connection Box
2	Eindschak. LA in S11Q	Endschalter LA ein S11A	Limit Switch LR in S11Q
3	Eindschak. LA uit S15Q	Endschalter LA aus S15Q	Limit Switch LR out S15Q
4	Eindschak. RA in S12Q	Endschalter RA ein S12Q	Limit Switch RR in S12Q
5	Eindschak. RA uit S16Q	Endschalter RA aus S16Q	Limit Switch RR out S16Q
6	Pendelas Links	Pendel Achse Links	Oscillating Left
7	Pendelas Rechts	Pendel Rechts	Oscillating Right
8	Pendelas Horizontaal S18Q	Pendel Achse Hor. S18Q	Oscillating Axle S18Q

this drawing is property of Holland Lift International, by all rights reserved.
 diese zeichnung ist eigentum von Holland Lift International, by all rights reserved.
 deze tekening is eigendom van Holland Lift International, by auteursrecht voorbehouden volgens de wet

HOLLAND LIFT

Holland Lift International B.V.
Anodeweg 1
NL-1627 LJ Hoorn The Netherlands
T/F +31 (0)229-285555 / 285550
E service@hollandlift.com
W www.hollandlift.com

KASTEN/BEKABELIN
KASTEN/KABEL
BOXES/CABLES

Projekt:
EM-21-001

Zeichnungsnummer:

Rev.:

erstellt von:
Rothenbusch

Datum:
24.11.2014

Anlage:

Ort:

Blatt:
37

BEDIENINGSKAST STEUERPULT CONTROL BOX

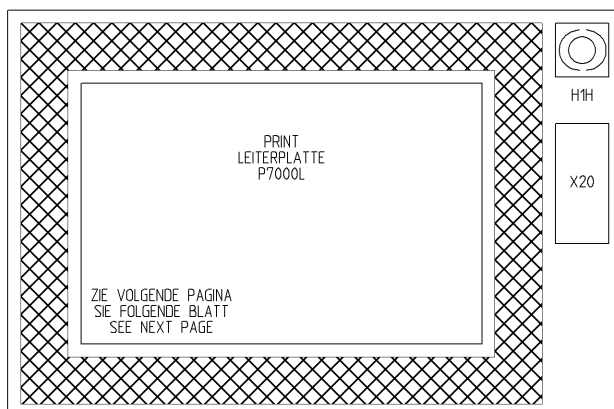
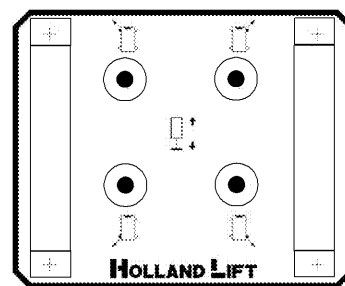
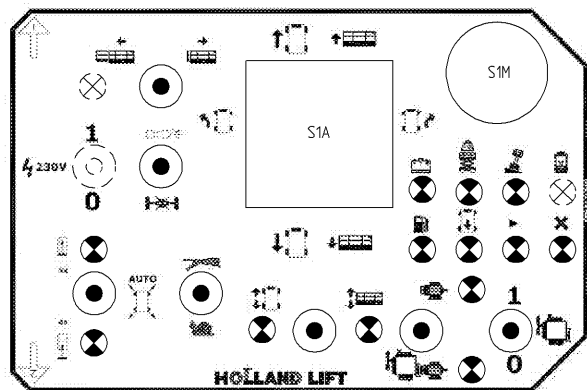

Colour schedule			
Colour	Dutch	English	Deutsch
Rd	Rood	Red	Rot
BL	Blauw	Blue	Blau
Gt	Geel	Yellow	Gelb
Gn	Groen	Green	Gruen
Zw	Zwart	Black	Schwarz
Wt	Wit	White	Weiss
Bn	Bruin	Brown	Braun
Rs	Roze	Pink	Rosa
Or	Oranje	Orange	Orange
Ps	Poars	Violet	Violett
Tp	Transp.	Transp.	Transp.
Gs	Grijs	Grey	Grau

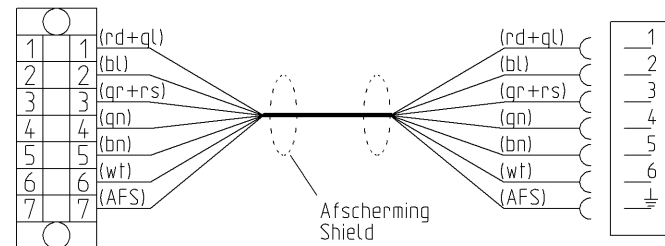
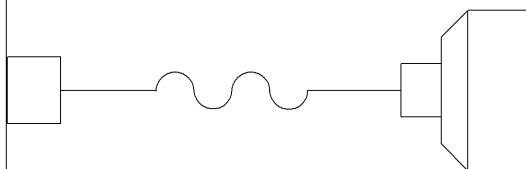

this drawing is property of Holland Lift International, by all rights reserved
 deze tekening is eigendom van Holland Lift International, by auteursrecht voorbehouden volgens de wet
 deze tekening is eigendom van Holland Lift International, by auteursrecht voorbehouden volgens de wet

HOLLAND LIFT

Holland Lift International B.V.
 Anodeweg 1
 NL-1627 LJ Hoorn The Netherlands
 T/F +31 (0)229-285555 / 285550
 E service@hollandlift.com
 W www.hollandlift.com

KASTEN/BEKABELING
 KASTEN/KABEL
 BOXES/CABLES

Projekt: EM-21-001

Zeichnungsnummer:

Rev.:

erstellt von:
 Rothenbusch

Datum: 24.11.2014

Anlage:

Ort:

Blatt: 38

PRINTPLAAT
LEITERPLATTE
CIRCUIT BOARD

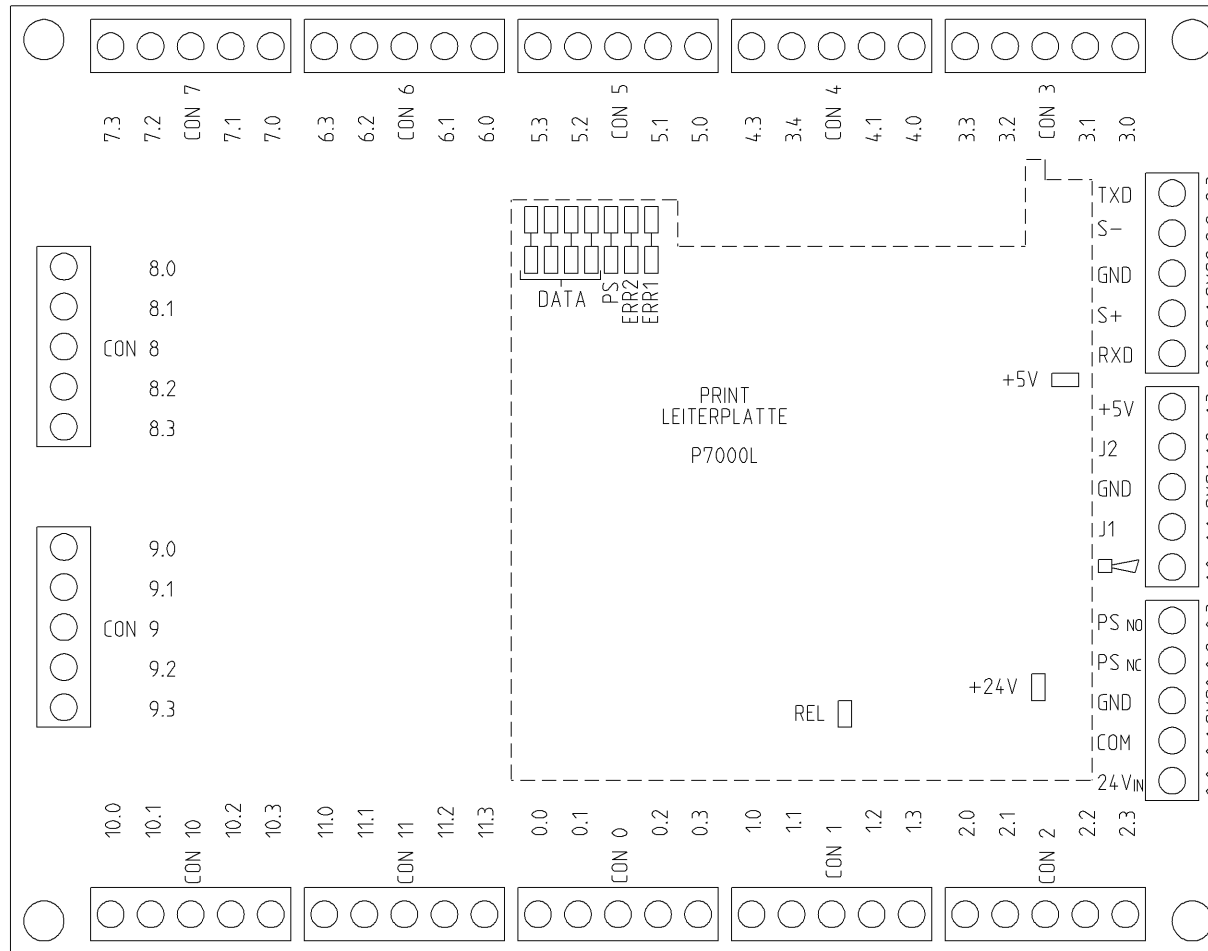

+24V	<input type="checkbox"/>	Groen/Gruen/Green	Voeding Ok	Speisung Ok	Supply Ok
+5V	<input type="checkbox"/>	Groen/Gruen/Green	Voeding Ok	Speisung Ok	Supply Ok
REL	<input type="checkbox"/>	Groen/Gruen/Green	Power Safe aan	Power Safe an	Power Safe on
PS	<input type="checkbox"/>	Geel/Gelb/Yellow	Power Safe uit	Power Safe aus	Power Safe off
Err1	<input type="checkbox"/>	Geel/Gelb/Yellow	Slechte Data Verbinding	Schlechte Data Verbindung	Poor Data Connection
Err2	<input type="checkbox"/>	Rood/Rot/Red	Geen Data Verbinding	Keine Data Verbindung	No Data Connection

this drawing is property of Holland Lift International, by all rights reserved.
 diese zeichnung ist eigentum von Holland Lift International, by urheberrecht vorbehalten nach dem gesetz
 deze tekening is eigendom van Holland Lift International, by auteursrecht voorbehouden volgens de wet

HOLLAND LIFT

Holland Lift International B.V.
 Anodeweg 1
 NL-1627 LJ Hoorn The Netherlands
 T/F +31 (0)229-285555 / 285550
 E service@hollandlift.com
 W www.hollandlift.com

PRINTPLAAT
LEITERPLATTE
CIRCUIT BOARD

Projekt:
EM-21-001

Zeichnungsnummer:

Rev.:

erstellt von:
Rothenbusch

Datum:
24.11.2014

Anlage:

Ort:

Blatt:
39

this drawing is property of Holland Lift International, by all rights reserved
 deze tekening is eigendom van Holland Lift International, by all rights reserved
 deze tekening is eigendom van Holland Lift International, by auteursrecht voorbehouden volgens de wet

0.0	Joystick Op (S1A2)	Fahren Joy. Auf (S1A2)	Joystick On (S1A2)
0.1	Joystick Neer (S1A3)	Fahren Joy. Nied. (S1A3)	Joystick Down (S1A3)
CON 0			
0.2	Sturen Links (S1A4)	Lenken Links (S1A4)	Steering Left (S1A4)
0.3	Sturen Rechts (S1A5)	Lenken Rechts (S1A5)	Steering Right (S1A5)

1.0	Claxon (S2A3)	Hupe (S2A3)	Horn (S2A3)
1.1	Sper/Diff. (S2A1)	Sperr/Diff. (S2A1)	Slip/Diff. (S2A1)
CON 1			
1.2	Heffen/Dalen (S3A1)	Heben/Senken (S3A1)	Lift Up/Down (S3A1)
1.3	Rijden/Sturen (S3A3)	Fahren/Lenken (S3A3)	Driving/Steering (S3A3)

2.0	Snel Rijden (S4A)	Schnell Fahren (S4A)	Driving Fast (S4A)
2.1	Reserve	Reserve	Spare
CON 2			
2.2	Reserve	Reserve	Spare
2.3	Dodemansknop (S1A1)	Totmansknopf (S1A1)	Dead Man (S1A1)

0.0	Voeding +24V (S1M)	Speisung +24V (S1M)	Supply +24V (S1M)
0.1	Voeding +24V (S1M)	Speisung +24V (S1M)	Supply +24V (S1M)
SYS0 GND	GND	GND	GND
0.2	Reserve	Reserve	Spare
0.3	Voeding +24V (PS)	Speisung +24V (PS)	Supply +24V (PS)

1.0	+ Zoemer (H1H)	+ Summer (H1H)	+ Buzzer (H1H)
1.1	0-5V Joystick P1	0-5V Joystick P1	0-5V Joystick P1
SYS1 GND	- Zoemer (H1H)	- Summer (H1H)	- Buzzer (H1H)
1.2	Reserve (0-5V)	Reserve (0-5V)	Spare (0-5V)
1.3	Voeding +5V Joy. (P1)	Speisung +5V Joy. (P1)	Supply +5V Joy. (P1)

2.0	Data RXD	Data RXD	Data RXD
2.1	Data S+ (RS485)	Data S+ (RS485)	Data S+ (RS485)
SYS2 GND	Reserve	Reserve	Spare
2.2	Data S- (RS485)	Data S- (RS485)	Data S- (RS485)
2.3	Data TXD	Data TXD	Data TXD

3.0	Hybrid Mode (S26A1)	Hybrid Mode (S26A1)	Hybrid Mode (S26A1)
3.1	Electric Mode (S26A3)	Elektro Mode (S26A3)	Electric Mode (S26A3)
CON 3			
3.2	4x Stempels in (S12A3)	4x Stuetzen ein (S12A1)	4x Jacks in (S12A1)
3.3	4x uit Au. Niv. (S12A2)	4x aus Au. Niv. (S12A2)	4x out Au. Niv.(S12A2)

4.0	Platform in (S10A3)	Plattform ein (S10A3)	Platform in (S10A3)
4.1	Platform uit (S10A1)	Plattform aus (S10A1)	Platform out (S10A1)
CON 4			
4.2	Reserve	Reserve	Spare
4.3	Reserve	Reserve	Spare

5.0	Vetpomp Opt. (V7H)	Fett Pumpe Opt. (V7H)	Grease Pu. Opt. (V7H)
5.1	Overload (V1H)	Ueberlastung (V1H)	Overload (V1H)
CON 5			
5.2	Scheefstand (V2H)	Neigung (V2H)	Inclination (V2H)
5.3	Tank leeg (V8H)	Tank leer (V8H)	Tank empty (V8H)

6.0	Start Motor (S11A3)	Start Motor (S11A3)	Start Engine (S11A3)
6.1	Stop Motor (S11A1)	Halt Motor (S11A1)	Stop Engine (S11A1)
CON 6			
6.2	Gen. aan Opt. (S18A3)	Gen. an Opt. (S18A3)	Gen. on Opt. (S18A3)
6.3	Gen. uit Opt. (S18A1)	Gen. aus Opt. (S18A1)	Gen. off Opt. (S18A1)

7.0	Stempels LA in (S15A1)	Stuetzen LH ein (S15A1)	Jacks LR in (S15A1)
7.1	Stemp. LA uit (S15A3)	Stuetzen LH aus (S15A3)	Jacks LR out (S15A3)
CON 7			
7.2	Stempels RA in (S16A1)	Stuetzen RH ein (S16A1)	Jacks RR in (S16A1)
7.3	Stemp. RA uit (S16A3)	Stuetzen RH aus (S16A3)	Jacks RR out (S16A3)

8.0	Stempels LV in (S13A1)	Stuetzen LV ein (S13A1)	Jacks LF in (S13A1)
8.1	Stemp. LV uit (S13A3)	Stuetzen LV aus (S13A3)	Jacks LF out (S13A3)
CON 8			
8.2	Stempels RV in (S14A1)	Stuetzen RV ein (S14A1)	Jacks RF in (S14A1)
8.3	Stemp. RV uit (S14A3)	Stuetzen RV aus (S14A3)	Jacks RF out (S14A3)

9.0	Pendelas Hor. (V4H)	Pendel Achse Hor. (V4H)	Os. Axle Hor. (V4H)
9.1	Stempels in (V11H)	Stuetzen ein (V11H)	Jacks in (V11H)
CON 9			
9.2	Stempels uit (V5H)	Stuetzen aus (V5H)	Jacks out (V5H)
9.3	Auto Niv. (V9H)	Auto Niv. (V9H)	Auto Niv. (V9H)

10.0	In Bedrijf (V10H)	In Betrieb (V10H)	Run (V10H)
10.1	Storing Dieselm. (V3H)	Stoerung Dieselm. (V3H)	Failure Dieselm. (V3H)
CON 10			
10.2	Accu geladen (V16H)	Akku geladen (V16H)	Battery loaded (V16H)
10.3	Accu leeg (V16H)	Akku leer (V16H)	Battery empty (V16H)

11.0	Heffen/Dalen (V12H)	Heben/Senken (V12H)	Lift Up/Down (V12H)
11.1	Rijden/Sturen (V13H)	Fahren/Lenken (V13H)	Driving/Steering (V13H)
CON 11			
11.2	Hybrid Mode (V14H)	Hybrid Mode (V14H)	Hybrid Mode (V14H)
11.3	Electric Mode (V15H)	Elektro Mode (V15H)	Electric Mode (V15H)



Holland Lift International B.V.
 Anodeweg 1
 NL-1627 LJ Hoorn The Netherlands
 T/F +31 (0)229-285555 / 285550
 E service@hollandlift.com
 W www.hollandlift.com

PRINTPLAAT
 LEITERPLATTE
 CIRCUIT BOARD

Projekt:	EM-21-001	Zeichnungsnummer:	Rev.:	erstellt von:
Datum:	24.11.2014	Antage:	Ort:	Rothenbusch
		=	+	Blatt: 40