

AANSLUITKLEM KLEMMENKAST ⚡ ANSCHLUSSKLEMME KLEMMKASTEN TERMINAL CONNECTION BOX  AANSLUITKLEM BEDIENINGSKAST ⚡ ANSCHLUSSKLEMME STEUERPULT TERMINAL CONTROL BOX	AANSLUITKLEM TRANSISTOR ⊕ ANSCHLUSSKLEMME TRANSISTOR TERMINAL TRANSISTOR  AANSLUITKLEM PLC ⊕ ANSCHLUSSKLEMME SPS TERMINAL PLC	AANSLUITKLEM PLC-SLAVE ⚡ ANSCHLUSSKLEMME SPS-SLAVE TERMINAL PLC-SLAVE
---	---	---

TYPE		OMSCHRIJVING UMSCHREIBUNG DESCRIPTION	PLC PROG: SPS PROG: PLC PROG:
HL330EL14		PROTO	HL330-E-01A
REV.	DATUM DATUM DATE	OPMERKING BEMERKUNG REMARK	

this drawing is property of Holland Lift International, by all rights reserved  
 diese zeichnung ist eigentum von Holland Lift International, by urheberrecht vorbehalten nach dem gesetz  
 deze tekening is eigendom van Holland Lift International, by auteursrecht voorbehouden volgens de wet



Holland Lift International B.V.  
 Anodeweg 1  
 NL-1627 LJ Hoorn The Netherlands  
 T/F +31 (0)229-285555 / 285550  
 E service@hollandlift.com  
 W www.hollandlift.com

INDEX BLAD  
 INDEX BLATT  
 INDEX SHEET

Projekt:	EN-21-001	Zeichnungsnummer:	Rev.:	erstellt von:
Datum:	22.05.2015	Antlage:	Ort:	Rothenbusch
		=	+	Blatt: 1

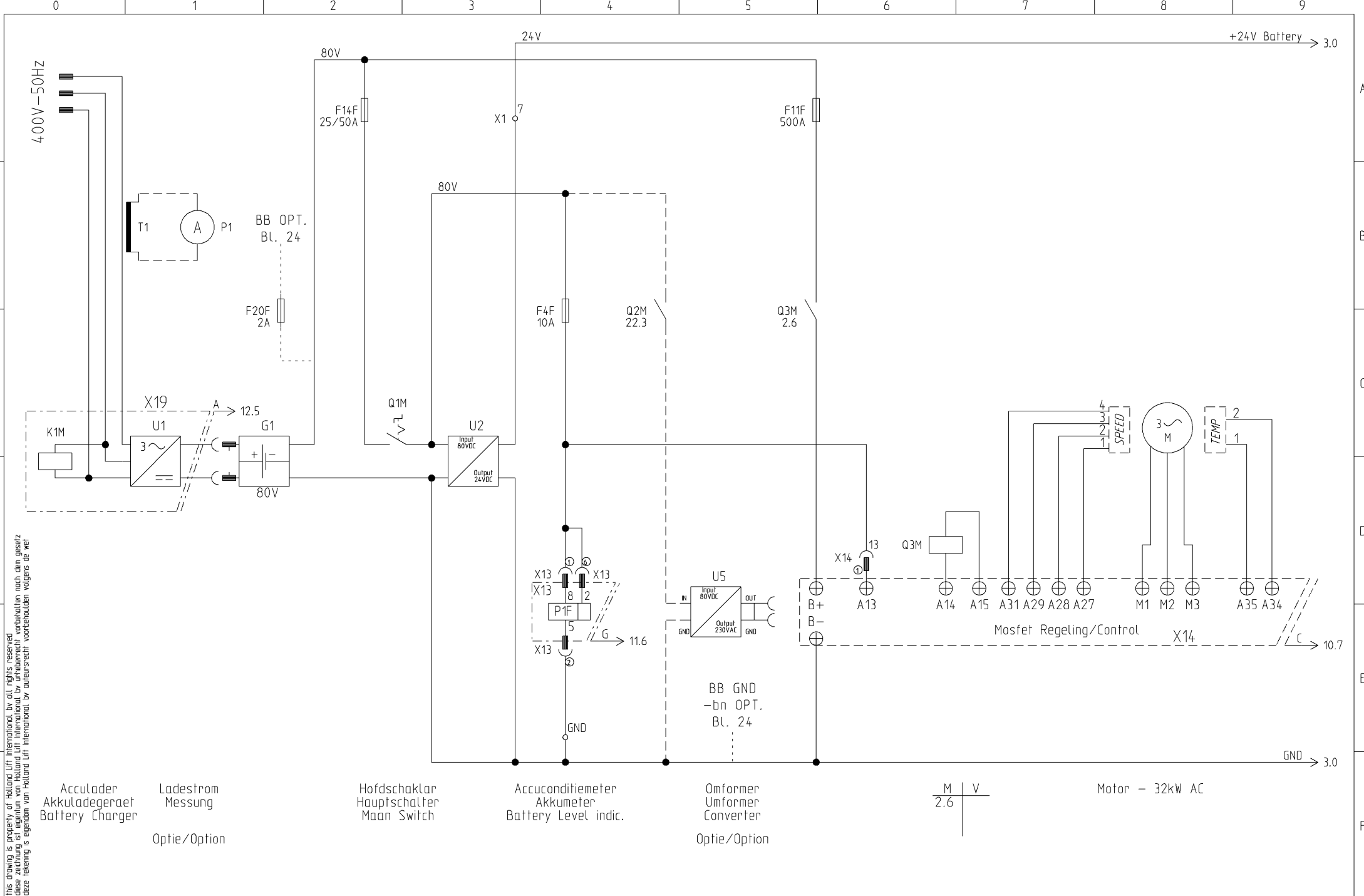

this drawing is property of Holland Lift International, by all rights reserved.  
 deze tekening is eigendom van Holland Lift International, by all rights reserved.  
 deze tekening is eigendom van Holland Lift International, by all rights reserved.

Acculader  
Akkuladegeraet  
Battery Charger

Ladestrom  
Messung

Optie/Option

Hofdschaklar  
Hauptschalter  
Main Switch

Accucondiometer  
Akkumeter  
Battery Level indic.

Omformer  
Umformer  
Converter

Optie/Option

M | V  
2.6

Motor - 32kW AC



Holland Lift International B.V.  
Anodeweg 1  
NL-1627 LJ Hoorn The Netherlands  
T/F +31 (0)229-285555 / 285550  
E service@hollandlift.com  
W www.hollandlift.com

STROOMKRINGSCHEMA  
STROMLAUFPLAN  
CIRCUIT DIAGRAM

Projekt: EN-21-001

Zeichnungsnummer:

Rev.:  
erstellt von:  
Rothenbusch

Datum: 22.05.2015

Anlage: =

Ort: +  
Blatt: 2

this drawing is property of Holland Lift International. By all rights reserved.  
 deze tekening is eigendom van Holland Lift International. By auteursrecht voorbehouden volgens de wet.  
 deze tekening is eigendom van Holland Lift International. By auteursrecht voorbehouden volgens de wet.

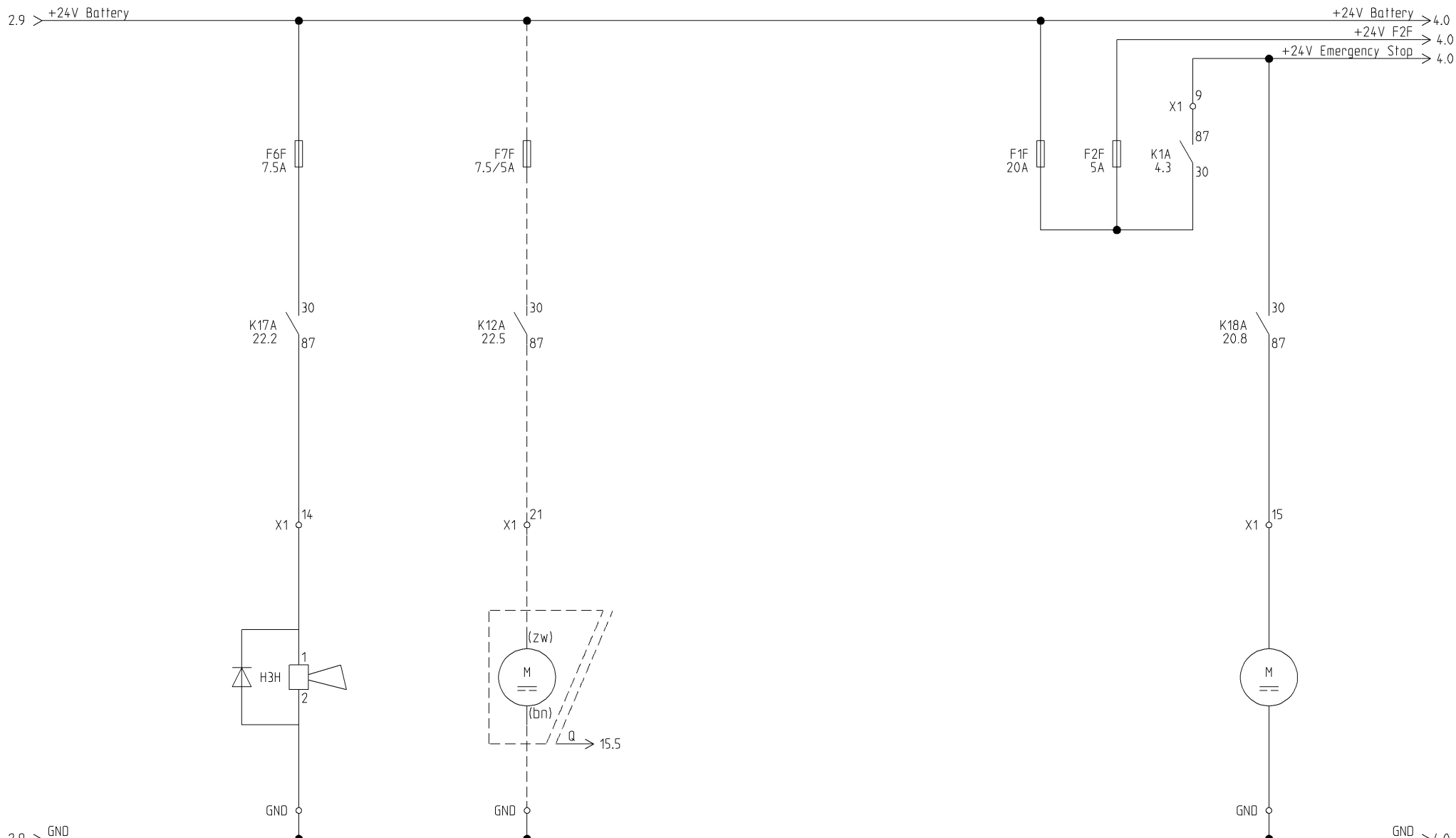

Claxon  
Hupe  
Horn

Vetpomp  
Fett Pumpe  
Grease Pump  
Optie/Option  
Zie Blz 25-27  
S. Blatt 25-27  
See Page 25-27

Koeler Mosfet Regeling  
Kuehler Mosfet Regelung  
Cooler Mosfet Control



Holland Lift International B.V.  
Anodeweg 1  
NL-1627 LJ Hoorn The Netherlands  
T/F +31 (0)229-285555 / 285550  
E service@hollandlift.com  
W www.hollandlift.com

STROOMKRINGSCHEMA  
STROMLAUFPLAN  
CIRCUIT DIAGRAM

Projekt:	EN-21-001	Zeichnungsnummer:	Rev.:	erstellt von:
Datum:	22.05.2015	Anlage:	Ort:	Rothenbusch
				Blatt:
				3

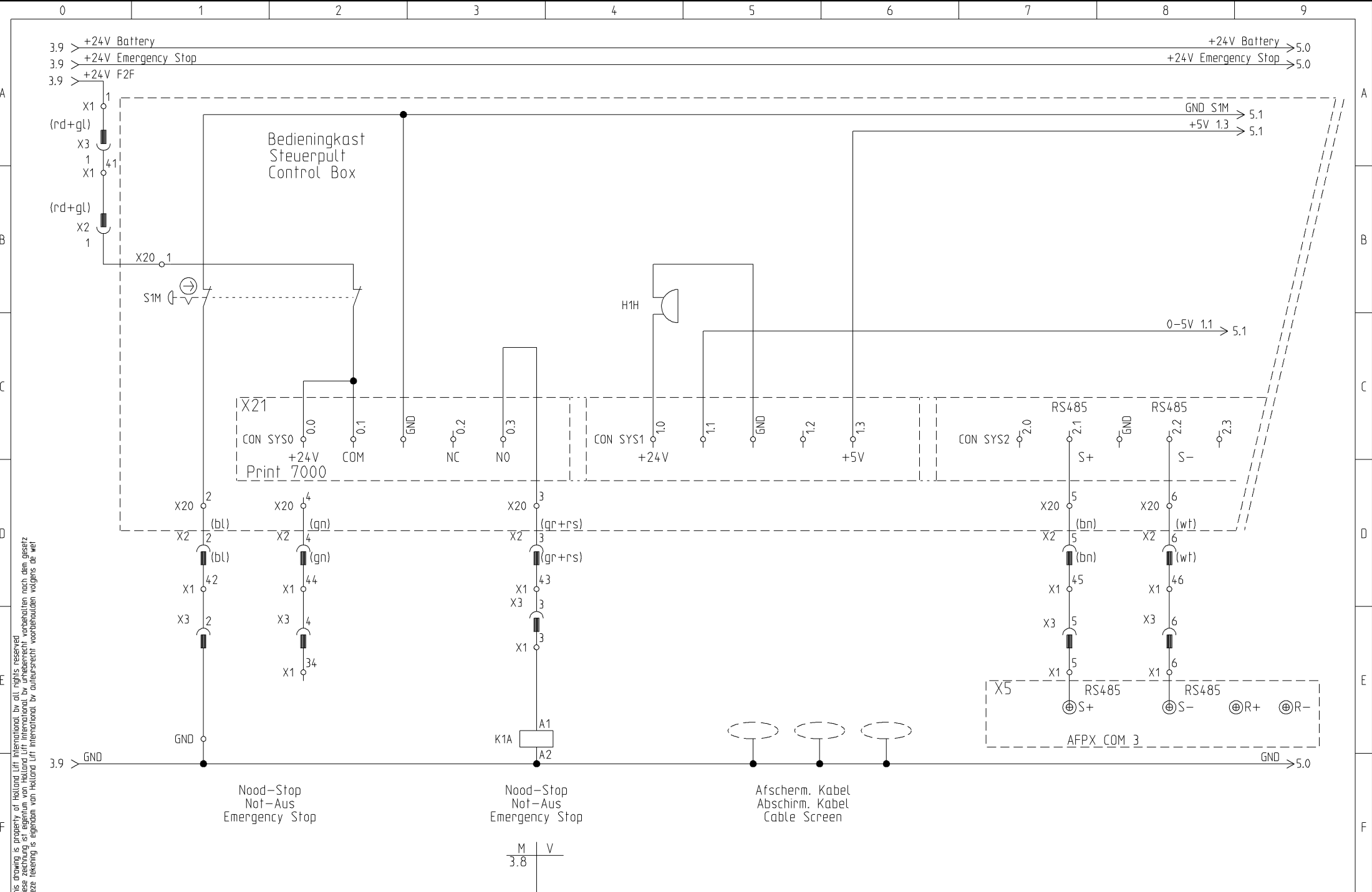

this drawing is property of Holland Lift International, by all rights reserved  
 deze tekening is eigendom van Holland Lift International, by all rights reserved  
 deze tekening is eigendom van Holland Lift International, by all rights reserved

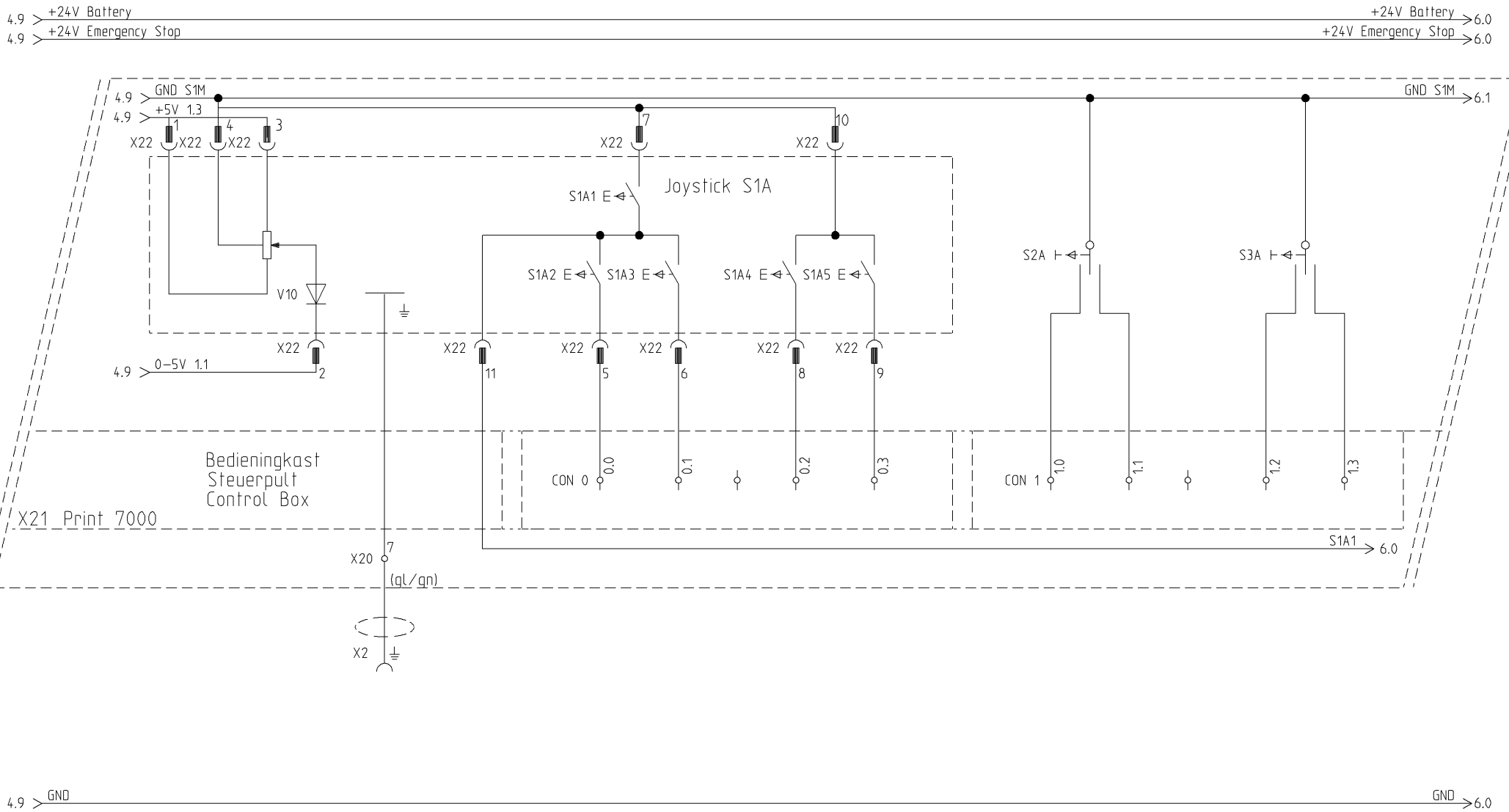

Bedieningkast  
Steuerpult  
Control Box

X21 Print 7000

Joystick S1A

S1A1 E

S1A2 E

S1A3 E

S1A4 E

S1A5 E

S2A E

S3A E

X20 7 (ql/qn)

S1A1 → 6.0

S1A1 Dodemansknop  
S1A1 Totmansknop  
S1A1 Dead Man's Button

Op-Joysick-Neer  
Auf-Joystick-Nieder  
On-Joystick-Down

Links-Sturen-Rechts  
Links-Lenken-Rechts  
Left-Steering-Right

Claxon-Sign.gever  
Hupe-Signalgeber  
Horn-Signal

Sper/Diff  
Sperr/Diff  
Stip/Diff

Heffen/Dalen  
Heben/Senken  
Lift Up/Lift Down

Rijden/Sturen  
Fahren/Lenken  
Driving/Steering

this drawing is property of Holland Lift International, by all rights reserved  
 diese zeichnung ist eigentum von Holland Lift International, by urheberrecht vorbehalten  
 deze tekening is eigendom van Holland Lift International, by auteursrecht voorbehouden volgens de wet



Holland Lift International B.V.  
Anodeweg 1  
NL-1627 LJ Hoorn The Netherlands  
T/F +31 (0)229-285555 / 285550  
E service@hollandlift.com  
W www.hollandlift.com

STROOMKRINGSHEMA  
STROMLAUFPLAN  
CIRCUIT DIAGRAM

Projekt:	EN-21-001	Zeichnungsnummer:	Rev.:	erstellt von:
Datum:	22.05.2015	Anlage:	Ort:	Rothenbusch
		=	+	Blatt: 5

5.9 > +24V Battery  
 5.9 > +24V Emergency Stop

+24V Battery > 7.0  
 +24V Emergency Stop > 7.0

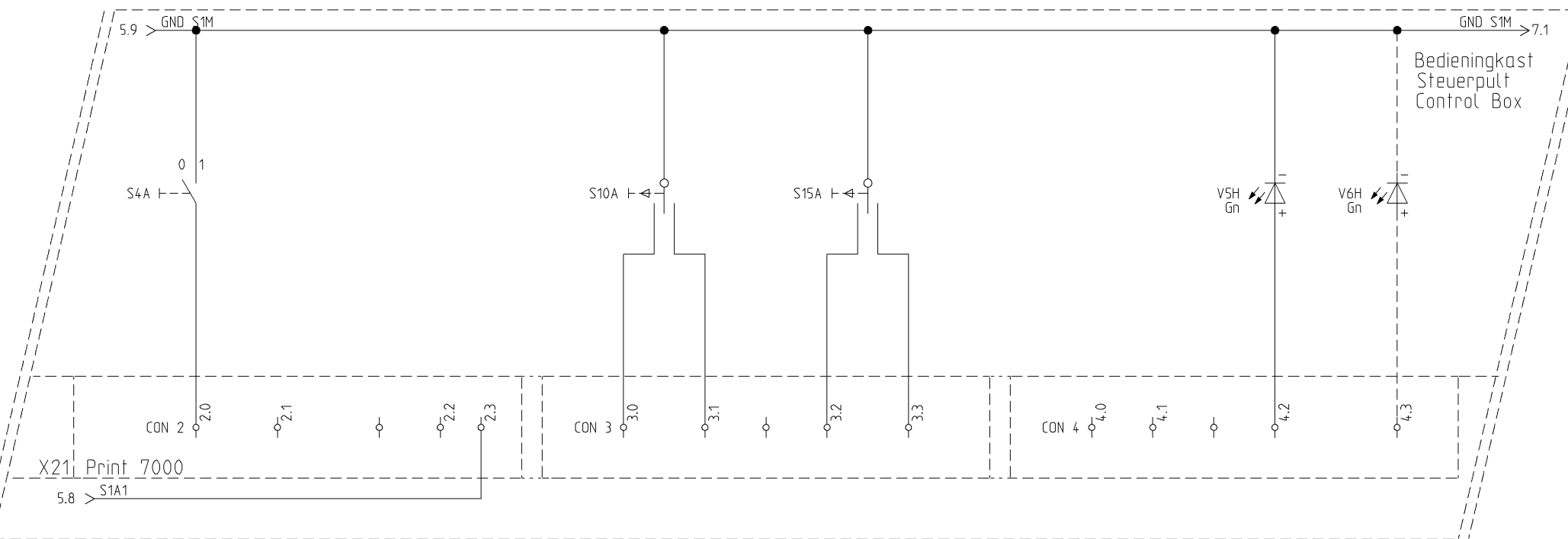

X21, Print 7000

S4A  
 0 = Langzaam Langsam Slow  
 1 = Snel Schnell Fast

this drawing is property of Holland Lift International, by all rights reserved  
 deze tekening is eigendom van Holland Lift International, by auteursrecht voorbehouden volgens de wet

Snelheid  
 Geschwindigkeit  
 Speed

S1A1 Dodemansknop  
 S1A1 Totmansknop  
 S1A1 Dead Man's Button

Links - Rechts  
 Links - Rechts  
 Left - Right

4xN-Stempels-Autom. Niveleer  
 4xN-Stuetzen-Autom. Nivel.  
 4xN-Jack-Autom. Nivel

Achter - As Recht - Voor  
 Hinten - Achse Gerade - Vorn  
 Rear - Axle Straight - Front

Sturen Achter  
 Lenken Hinten  
 Steering Rear

Optie/Option



Holland Lift International B.V.  
 Anodeweg 1  
 NL-1627 LJ Hoorn The Netherlands  
 T/F +31 (0)229-285555 / 285550  
 E service@hollandlift.com  
 W www.hollandlift.com

STROOMKRINGSCHEMA  
 STROMLAUFPLAN  
 CIRCUIT DIAGRAM

Projekt:	EN-21-001	Zeichnungsnummer:	Rev.:	erstellt von:
Datum:	22.05.2015	Antage:	Ort:	Rothenbusch
		=	+	Blatt:
				6

6.9 > +24V Battery  
 6.9 > +24V Emergency Stop

+24V Battery > 8.0  
 +24V Emergency Stop > 8.0

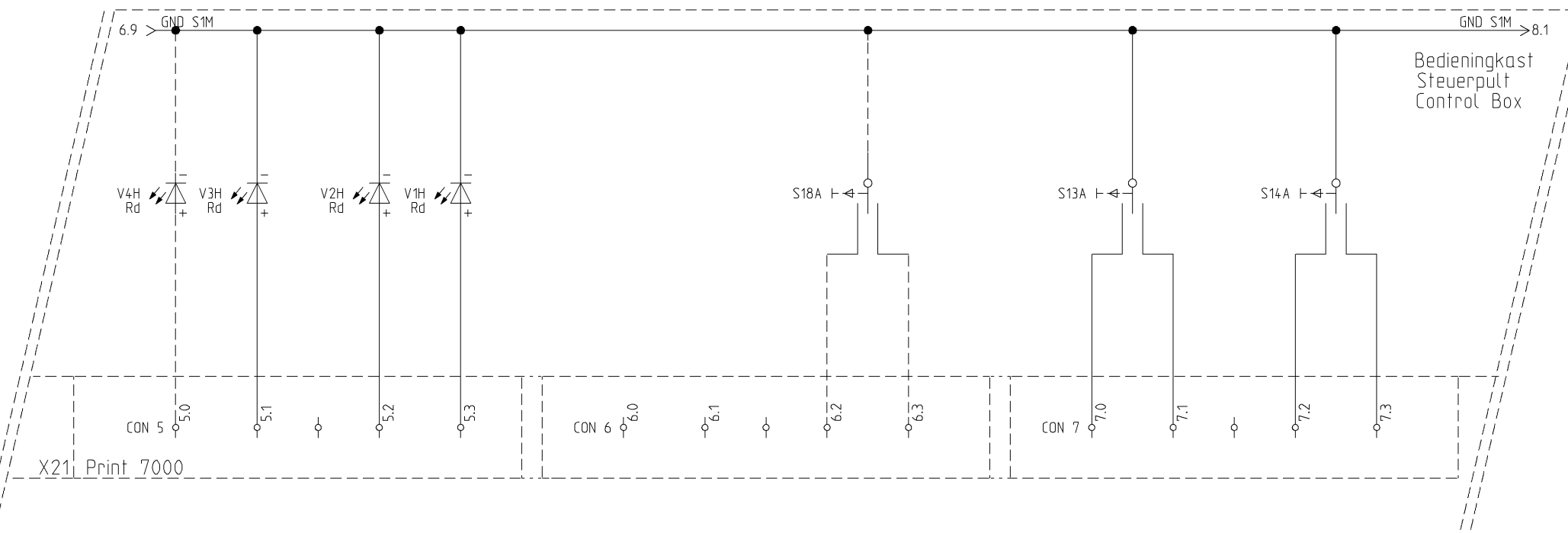

X21; Print 7000

6.9 > GND

GND > 8.0

Vetpomp    Overload    Scheefstand    Accu Leeg  
 Fett Pumpe    Ueberlastung    Neigung    Akku Leer  
 Grease Pump    Overload    Grade/Slope    Bat. Empty

Aan    Omformer    Uit  
 An    Umformer    Aus  
 On    Converter    Off

LA in    LA uit    RA in    RA uit  
 LH ein    LH aus    RH ein    RH aus  
 LR in    LR out    RR in    RR out

Optie/Option

Optie/Option

Stempels-Stuetzen-Jacks    Stempels-Stuetzen-Jacks

this drawing is property of Holland Lift International, by all rights reserved.  
 deze tekening is eigendom van Holland Lift International, by auteursrecht voorbehouden volgens de wet.  
 deze tekening is eigendom van Holland Lift International, by auteursrecht voorbehouden volgens de wet.



Holland Lift International B.V.  
 Anodeweg 1  
 NL-1627 LJ Hoorn The Netherlands  
 T/F +31 (0)229-285555 / 285550  
 E service@hollandlift.com  
 W www.hollandlift.com

STROOMKRINGSCHEMA  
 STROMLAUFPLAN  
 CIRCUIT DIAGRAM

Projekt: EN-21-001	Zeichnungsnummer:	Rev.:	erstellt von: Rothenbusch
Datum: 22.05.2015	Anlage: =	Ort: +	Blatt: 7

7.9 > +24V Battery  
 7.9 > +24V Emergency Stop

+24V Battery > 9.0  
 +24V Emergency Stop > 9.0

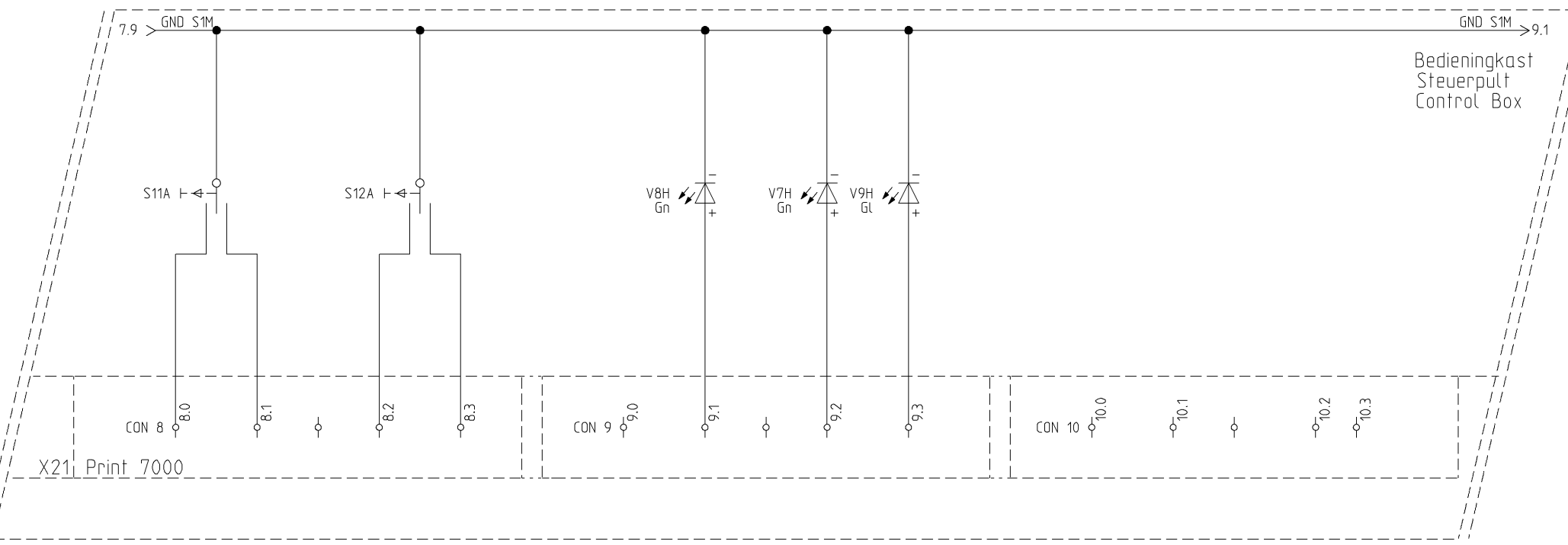

7.9 > GND

GND > 9.0

LV in    LV uit    RV in    RV uit  
 LV ein    LV aus    RV ein    RV aus  
 LF in    LF out    RF in    RF out

Stempels in    Stempels uit    Autom. Niv.  
 Stuetzen ein    Stuetzen aus    Autom. Niv.  
 Jacks in    Jacks out    Autom. Niv.

Stempels-Stuetzen-Jacks    Stempels-Stuetzen-Jacks

this drawing is property of Holland Lift International, by all rights reserved  
 deze tekening is eigendom van Holland Lift International, by auteursrecht voorbehouden volgens de wet  
 deze tekening is eigendom van Holland Lift International, by auteursrecht voorbehouden volgens de wet



Holland Lift International B.V.  
 Anodeweg 1  
 NL-1627 LJ Hoorn The Netherlands  
 T/F +31 (0)229-285555 / 285550  
 E service@hollandlift.com  
 W www.hollandlift.com

STROOMKRINGSHEMA  
 STROMLAUFPLAN  
 CIRCUIT DIAGRAM

Projekt:	EN-21-001	Zeichnungsnummer:	Rev.:	erstellt von:
Datum:	22.05.2015	Antlage:	Ort:	Rothenbusch
		=	+	Blatt: 8



this drawing is property of Holland Lift International, by all rights reserved  
 deze tekening is eigendom van Holland Lift International, by all rights reserved  
 deze tekening is eigendom van Holland Lift International, by all rights reserved

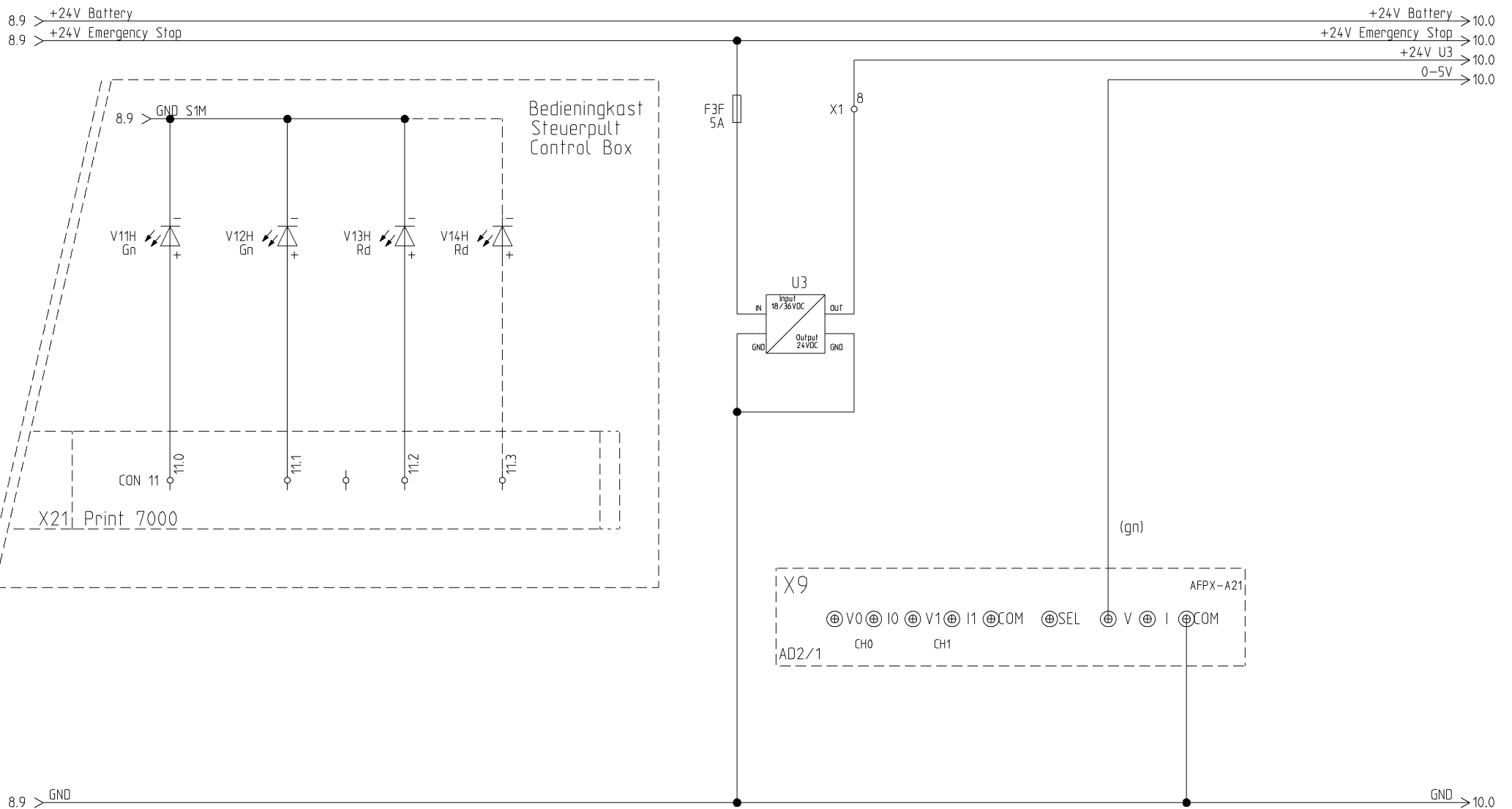

Rijden/Sturen Fahren/Lenken Driving/Steering	Heffen/Dalen Heben/Senken Lift Up/Lift Down	Alleen binnen gebruik Nur in Innenräumen Inside use only	Aan Omformer aan An Umformer an On Converter on
Optie/Option			Prop. Ventel Prop. Ventil Prop. Valve



Holland Lift International B.V.  
 Anodeweg 1  
 NL-1627 LJ Hoorn The Netherlands  
 T/F +31 (0)229-285555 / 285550  
 E service@hollandlift.com  
 W www.hollandlift.com

STROOMKRINGSHEMA  
 STROMLAUFPLAN  
 CIRCUIT DIAGRAM

Projekt: EN-21-001	Zeichnungsnummer:	Rev.:	erstellt von: Rothenbusch
Datum: 22.05.2015	Anlage: =	Ort: +	Blatt: 9

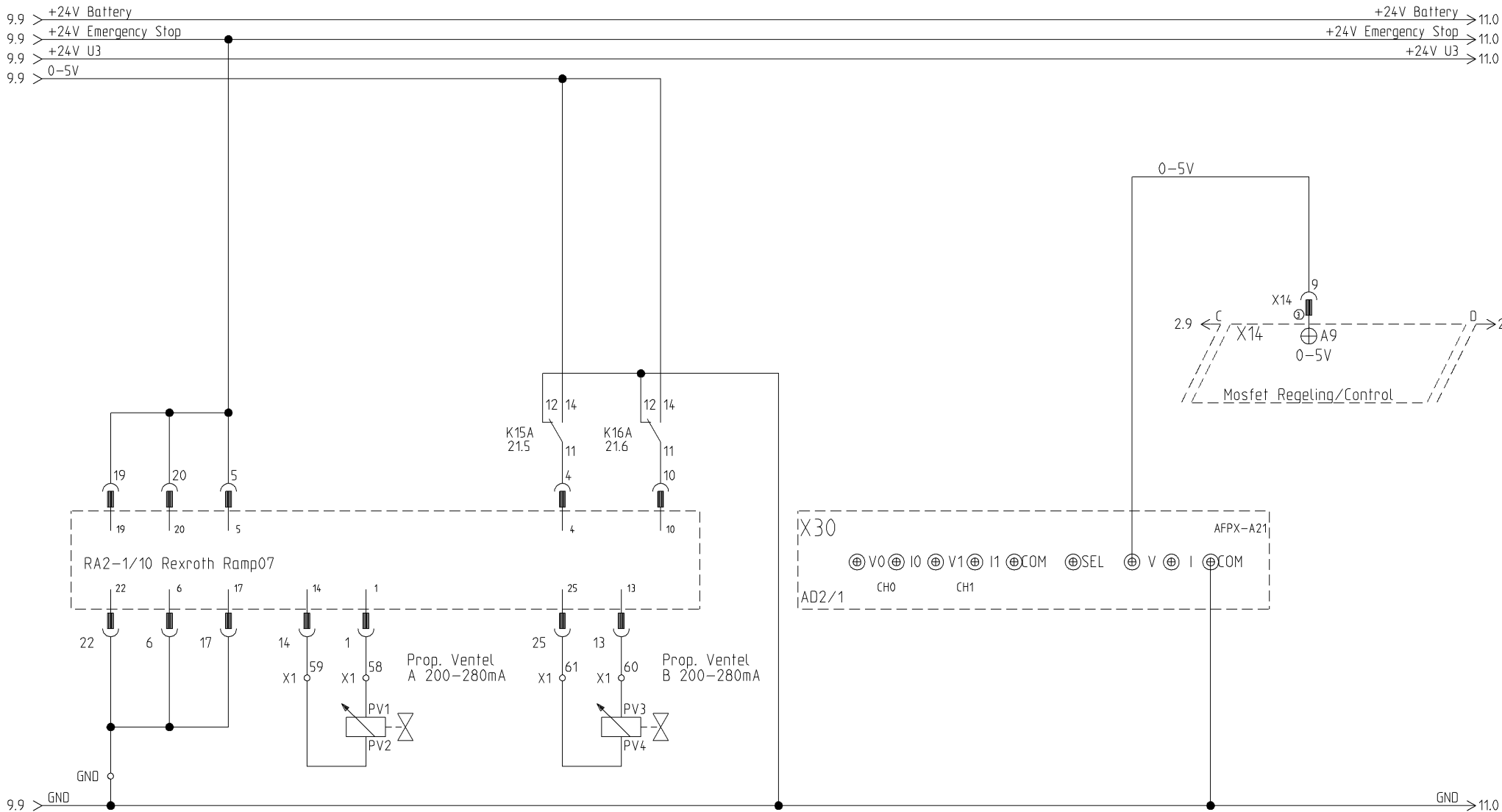

Rijden Vooruit/Heffen  
 Fahren Forwaerts/Heben  
 Driving Forward/Lift Up

Rijden Achteruit/Dalen  
 Fahren Rueckwaerts/Senken  
 Driving Reverse/Lift Down

Mosfet Regeling  
 0-5V

this drawing is property of Holland Lift International, by all rights reserved.  
 deze tekening is eigendom van Holland Lift International, by auteursrecht voorbehouden volgens de wet.  
 deze tekening is eigendom van Holland Lift International, by auteursrecht voorbehouden volgens de wet.



Holland Lift International B.V.  
 Anodeweg 1  
 NL-1627 LJ Hoorn The Netherlands  
 T/F +31 (0)229-285555 / 285550  
 E service@hollandlift.com  
 W www.hollandlift.com

STROOMKRINGSCHEMA  
 STROMLAUFPLAN  
 CIRCUIT DIAGRAM

Projekt: EN-21-001	Zeichnungsnummer:	Rev.:	erstellt von: Rothenbusch
Datum: 22.05.2015	Anlage: =	Ort: +	Blatt: 10

this drawing is property of Holland Lift International, by all rights reserved.  
 deze tekening is eigendom van Holland Lift International, by auteursrecht voorbehouden volgens de wet.  
 deze tekening is eigendom van Holland Lift International, by auteursrecht voorbehouden volgens de wet.

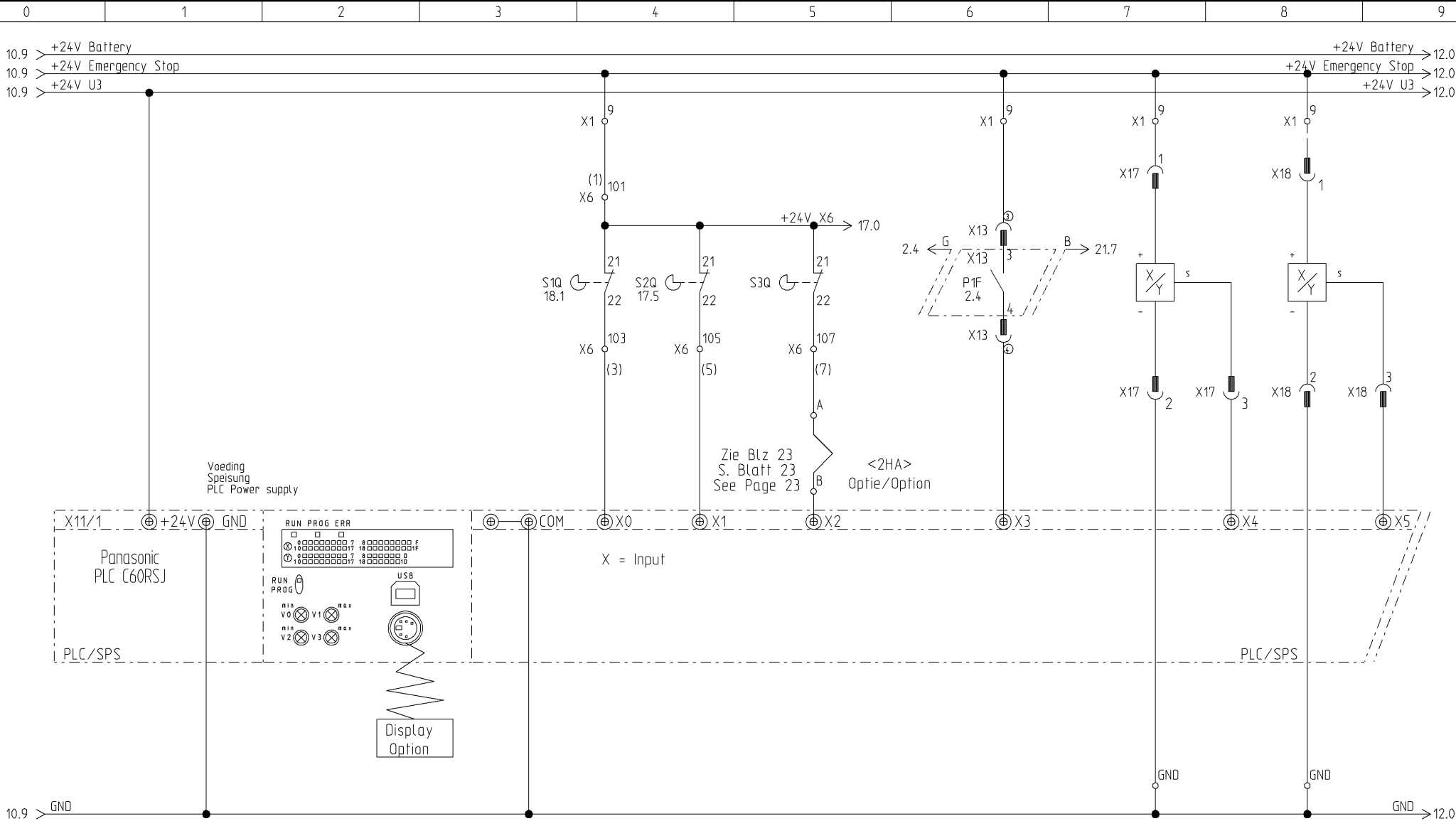

- 4 mtr. Afslag  
4 mtr. Ausschalt.  
4 mtr. Cut-Out
- 8 mtr. Afslag  
8 mtr. Ausschalt.  
8 mtr. Cut-Out
- Max. Hodgte  
Max. Hoehe  
Max. Height
- Accuconditiemeter  
Akkumeter  
Battery Level indic.
- Scheefstand 1  
Neigung 1  
Grade/Slope 1
- Scheefstand 2  
Neigung 2  
Grade/Slope 2

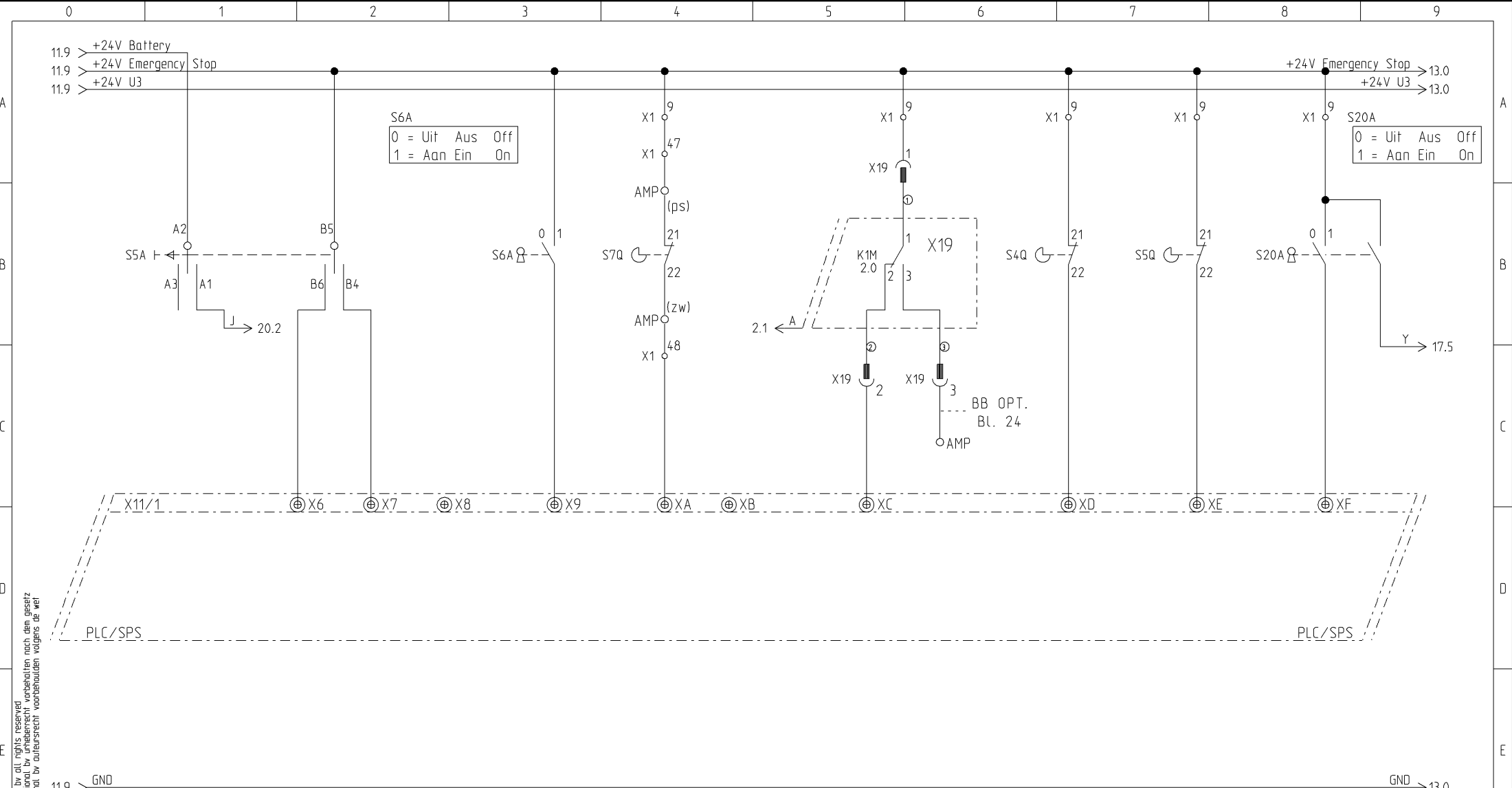

Heffen - Dalem  
 Heben - Senken  
 Lift Up - Lift Down

Reserve  
 Reserve  
 Spare

Overlastin aan  
 Ueberlastung ein  
 Overload on

Overlastin  
 Ueberlastung  
 Overload

Reserve  
 Reserve  
 Spare

Acculader  
 Akkuladegeraet  
 Battery Charger

Stab. links uit  
 Stab. links aus  
 Stab. left out

Stab. rechts uit  
 Stab. rechts aus  
 Stab. right out

Ri. max. Hoogte  
 Fa. max. Hoehe  
 Dr. max. Height

this drawing is property of Holland Lift International, by all rights reserved  
 deze tekening is eigendom van Holland Lift International, by all rights reserved  
 deze tekening is eigendom van Holland Lift International, by all rights reserved



Holland Lift International B.V.  
 Anodeweg 1  
 NL-1627 LJ Hoorn The Netherlands  
 T/F +31 (0)229-285555 / 285550  
 E service@hollandlift.com  
 W www.hollandlift.com

STROOMKRINGSHEMA  
 STROMLAUFPLAN  
 CIRCUIT DIAGRAM

Projekt: EN-21-001  
 Datum: 22.05.2015

Zeichnungsnummer:  
 Anlage: =

Rev.:  
 Ort: +

erstellt von:  
 Rothenbusch  
 Blatt: 12

this drawing is property of Holland Lift International, by all rights reserved  
 deze tekening is eigendom van Holland Lift International, by auteursrecht voorbehouden volgens de wet  
 deze tekening is eigendom van Holland Lift International, by auteursrecht voorbehouden volgens de wet

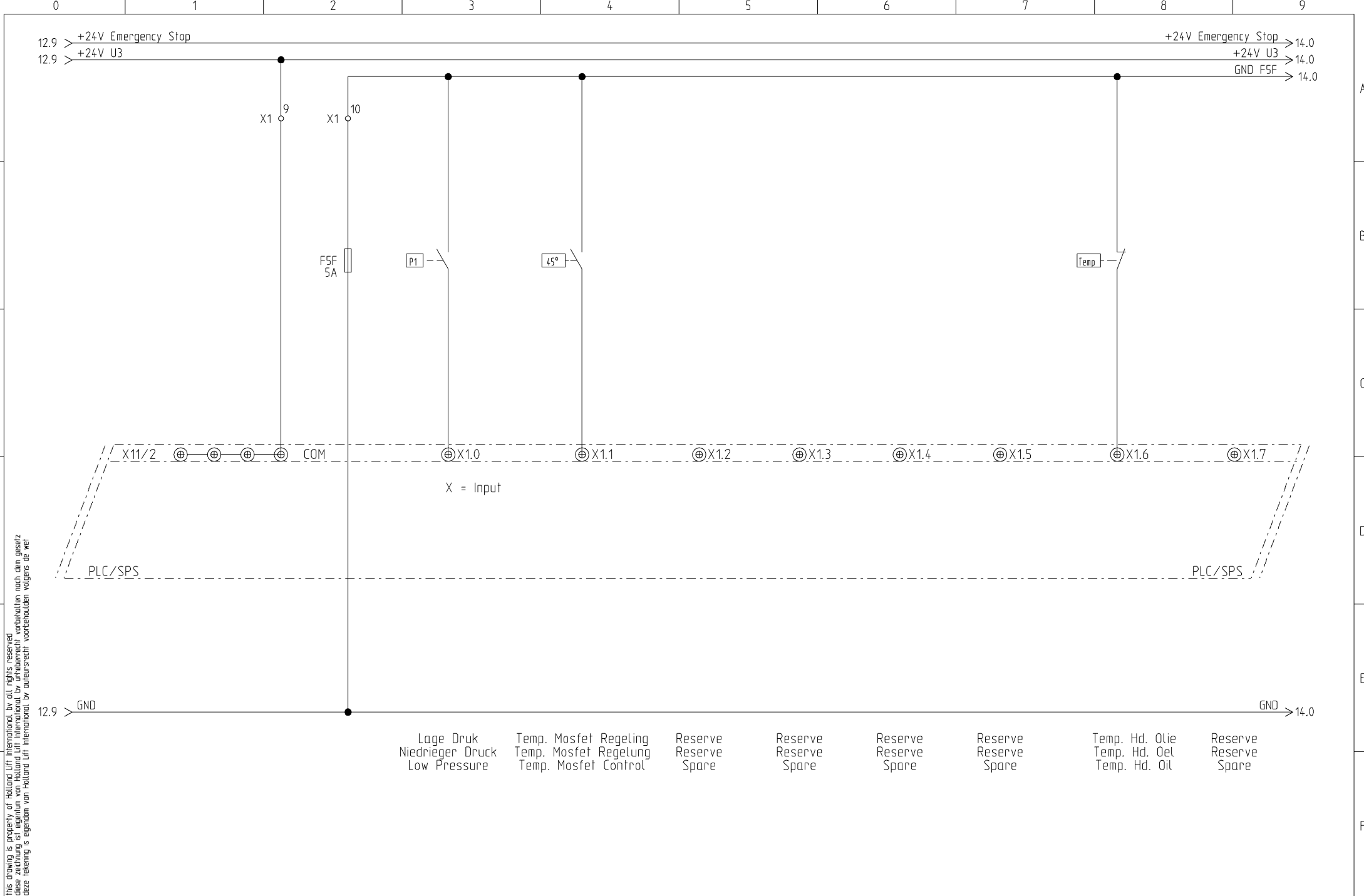

Holland Lift International B.V.  
 Anodeweg 1  
 NL-1627 LJ Hoorn The Netherlands  
 T/F +31 (0)229-285555 / 285550  
 E service@hollandlift.com  
 W www.hollandlift.com

STROOMKRINGSHEMA  
 STROMLAUFPLAN  
 CIRCUIT DIAGRAM

Projekt:	EN-21-001	Zeichnungsnummer:	Rev.:	erstellt von:
Datum:	22.05.2015	Antlage:	Ort:	Rothenbusch
		=	+	Blatt:
				13

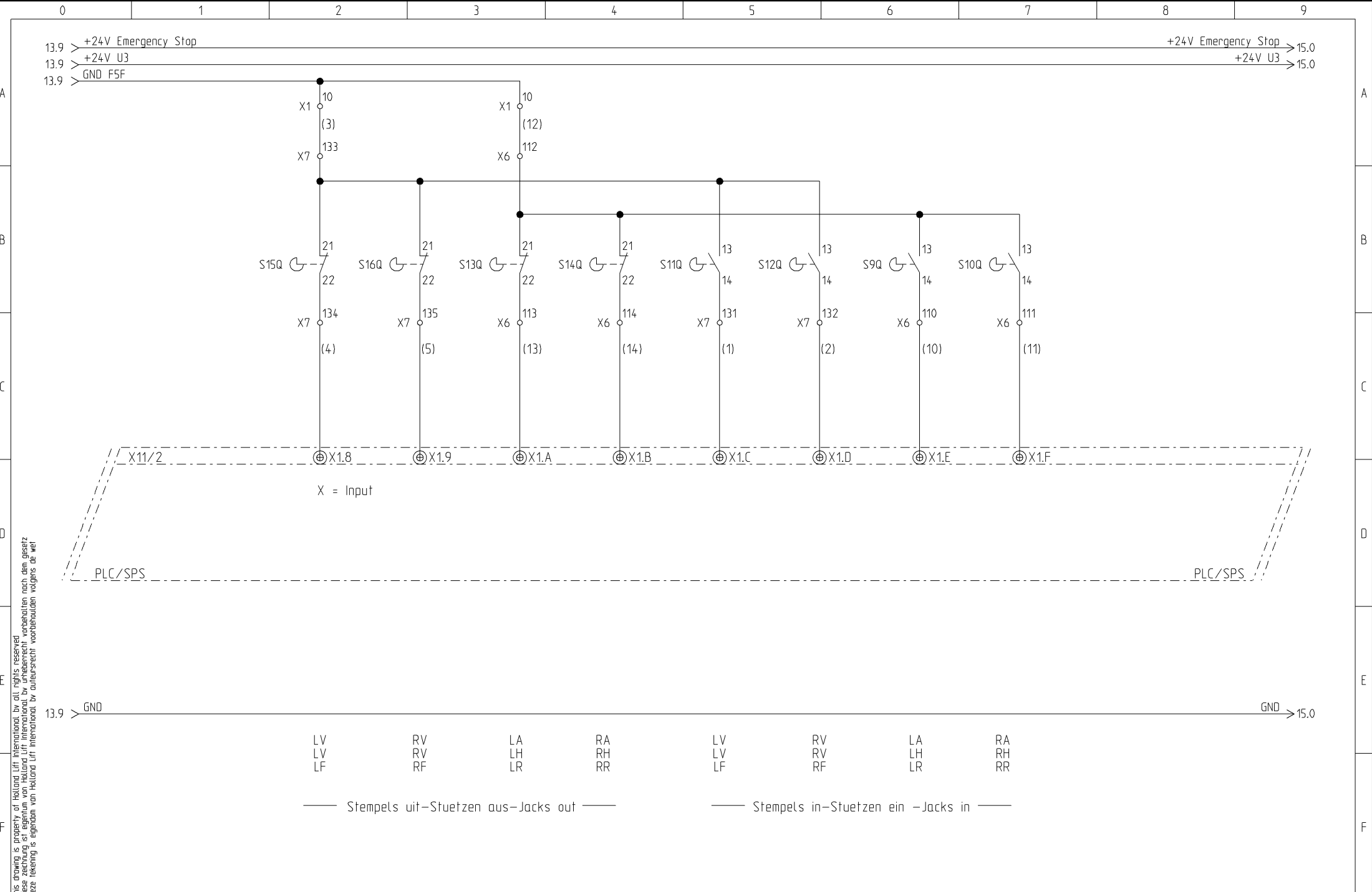

this drawing is property of Holland Lift International, by all rights reserved  
 deze tekening is eigendom van Holland Lift International, by all rights reserved  
 deze tekening is eigendom van Holland Lift International, by all rights reserved



Holland Lift International B.V.  
 Anodeweg 1  
 NL-1627 LJ Hoorn The Netherlands  
 T/F +31 (0)229-285555 / 285550  
 E service@hollandlift.com  
 W www.hollandlift.com

STROOMKRINGSCHMA  
 STROMLAUFPLAN  
 CIRCUIT DIAGRAM

Projekt: EN-21-001  
 Datum: 22.05.2015

Zeichnungsnummer:  
 Anlage: =

Rev.:  
 Ort: +

erstellt von:  
 Rothenbusch  
 Blatt: 14

This drawing is property of Holland Lift International. All rights reserved.  
 deze tekening is eigendom van Holland Lift International. Alle rechten voorbehouden volgens de wet.

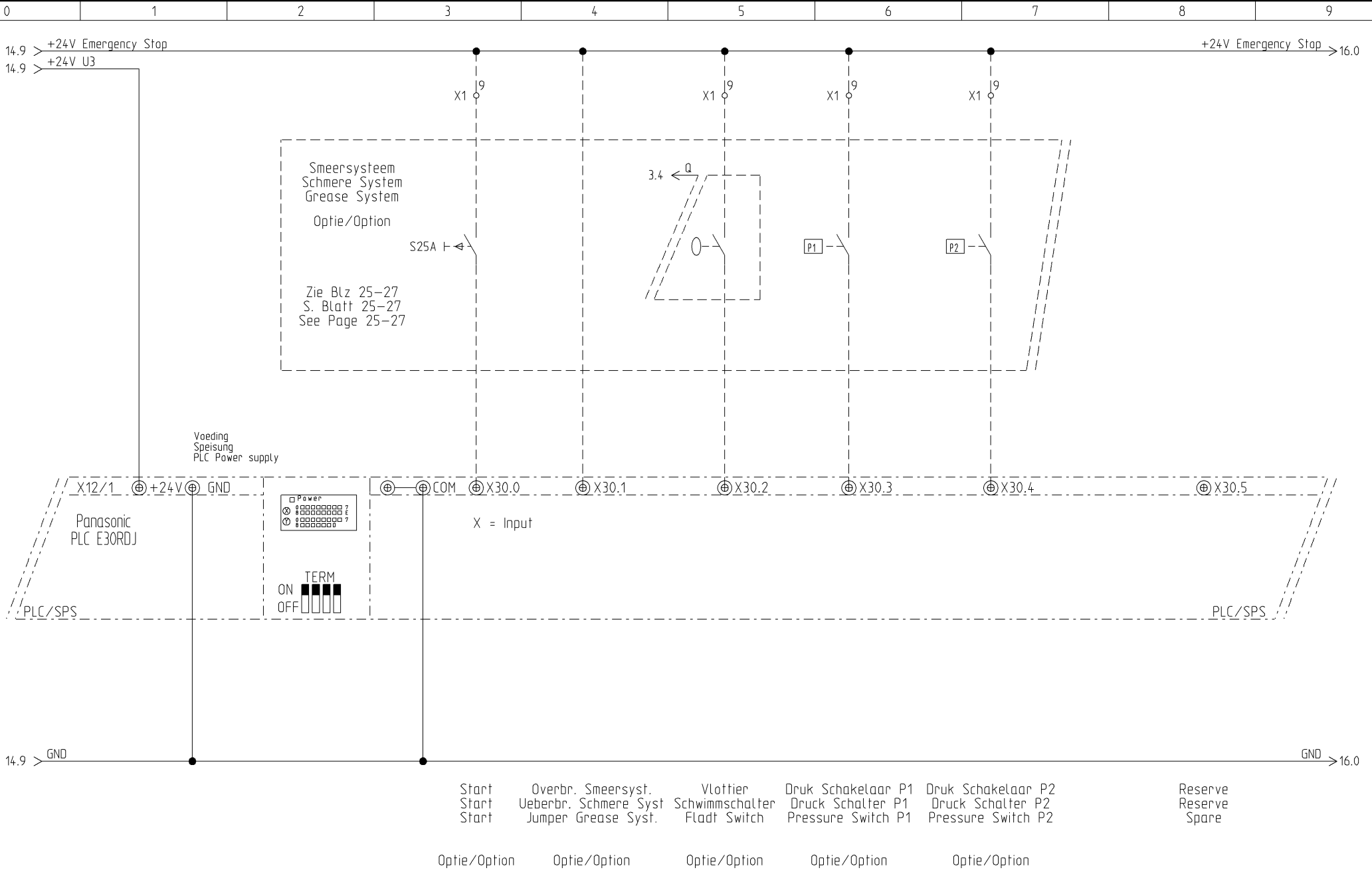

this drawing is property of Holland Lift International, by all rights reserved.  
 deze tekening is eigendom van Holland Lift International, by all rights reserved.  
 deze tekening is eigendom van Holland Lift International, by auteursrecht voorbehouden volgens de wet

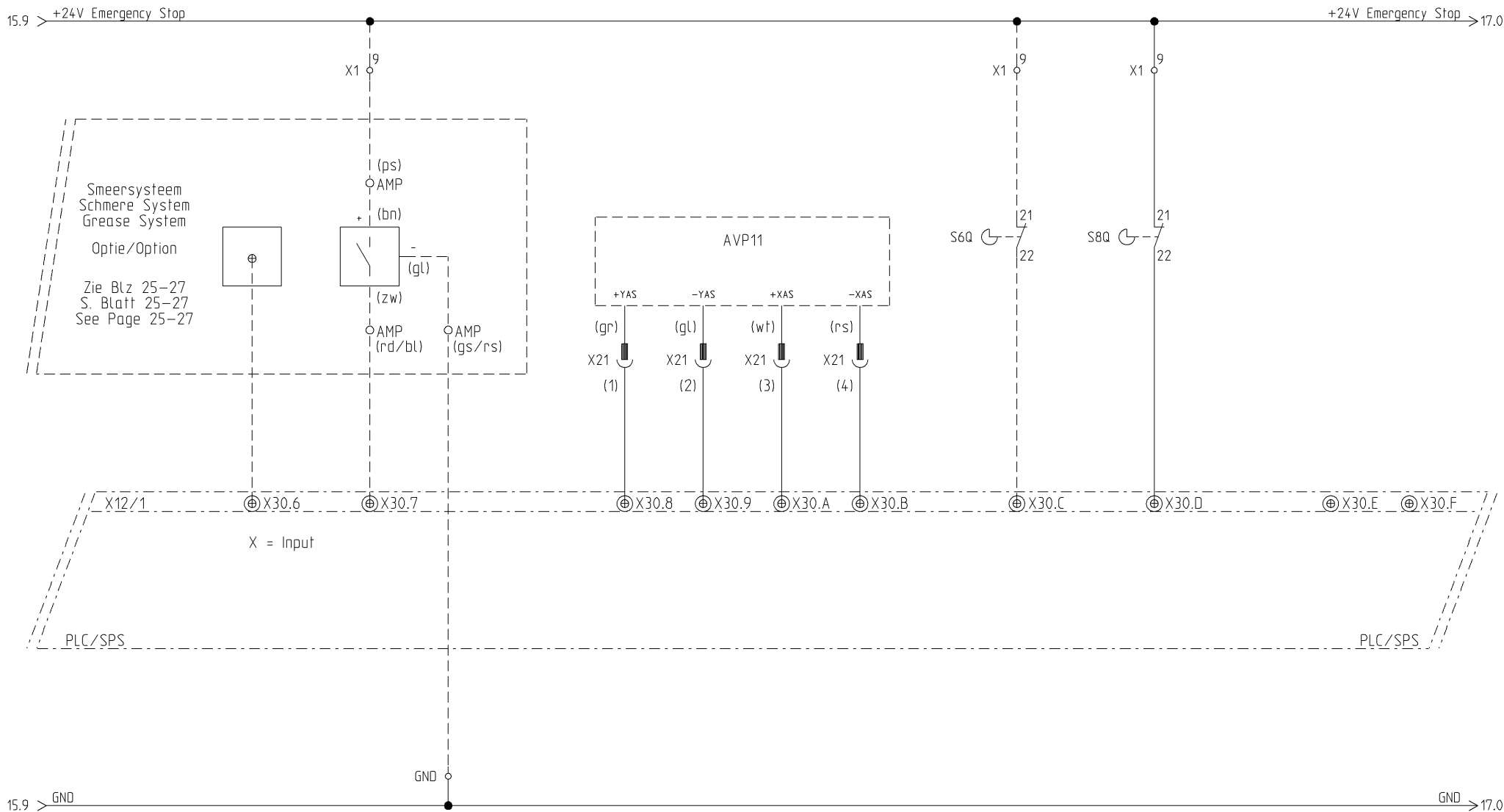

Hli Test Smeersyst.  
Hli Test Schmere Syst.  
Hli Test Grease Syst.

Sensor laatste Smeerpunt  
Sensor Letzter Schmierpunkt  
Sensor Last Grease Point

Autom. Waterpas  
Autom. Horizontal  
Autom. Level

Vooras - Horizontaal - Achteras  
Vorn - Achse Hor. - Hinten  
Front - Axle Hor. - Rear

Reserve Reserve  
Reserve Reserve  
Spare Spare

Optie/Option

Optie/Option

Optie/Option



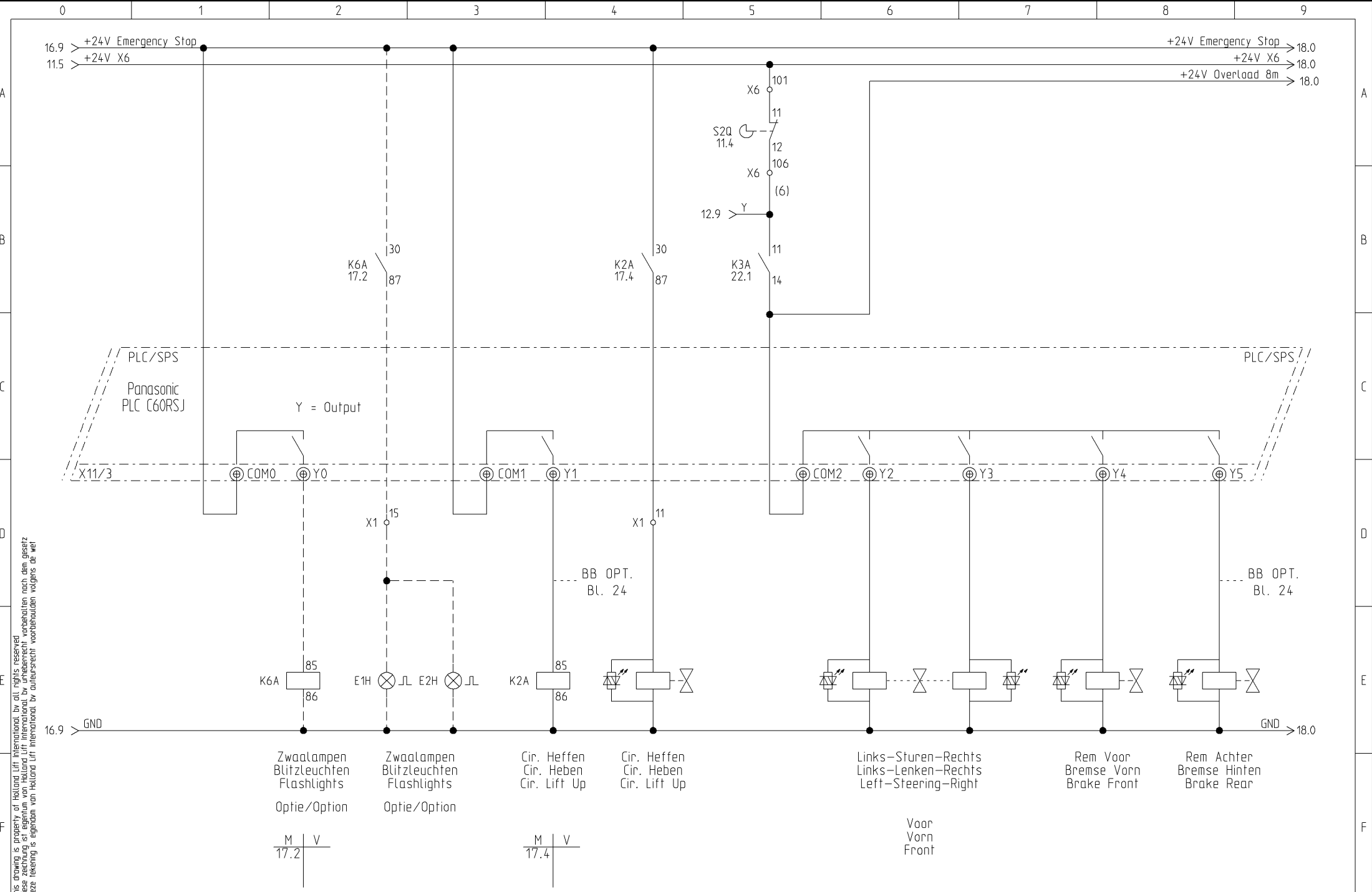

this drawing is property of Holland Lift International, by all rights reserved.  
 deze tekening is eigendom van Holland Lift International, by all rights reserved.  
 deze tekening is eigendom van Holland Lift International, by all rights reserved.

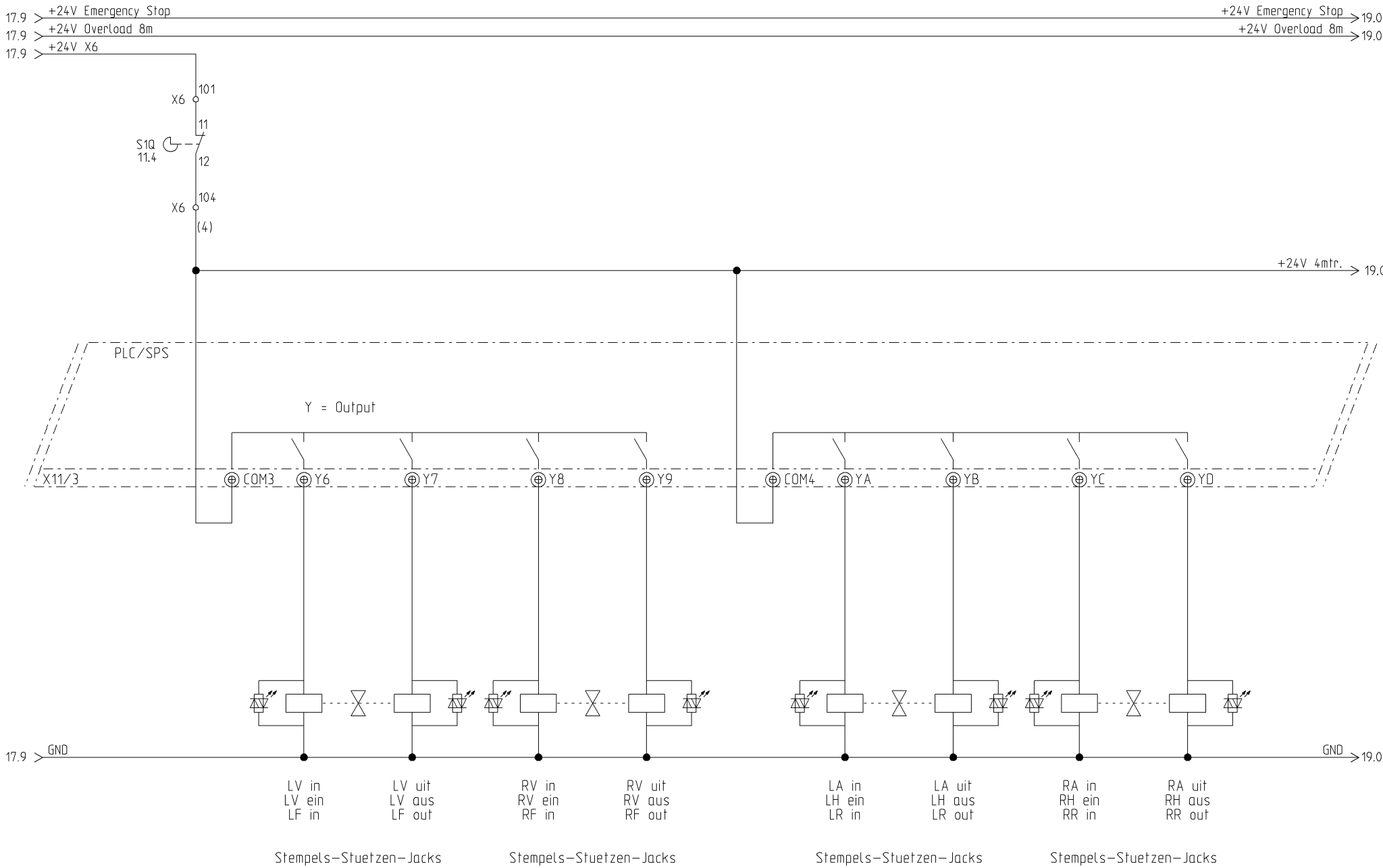

this drawing is property of Holland Lift International, by all rights reserved.  
 deze tekening is eigendom van Holland Lift International, by all rights reserved.  
 deze tekening is eigendom van Holland Lift International, by all rights reserved.



Holland Lift International B.V.  
 Anodeweg 1  
 NL-1627 LJ Hoorn The Netherlands  
 T/F +31 (0)229-285555 / 285550  
 E service@hollandlift.com  
 W www.hollandlift.com

STROOMKRINGSHEMA  
 STROMLAUFPLAN  
 CIRCUIT DIAGRAM

Projekt:	EN-21-001	Zeichnungsnummer:	Rev.:	erstellt von:
Datum:	22.05.2015	Anlage:	Ort:	Rothenbusch
				Blatt:
				18

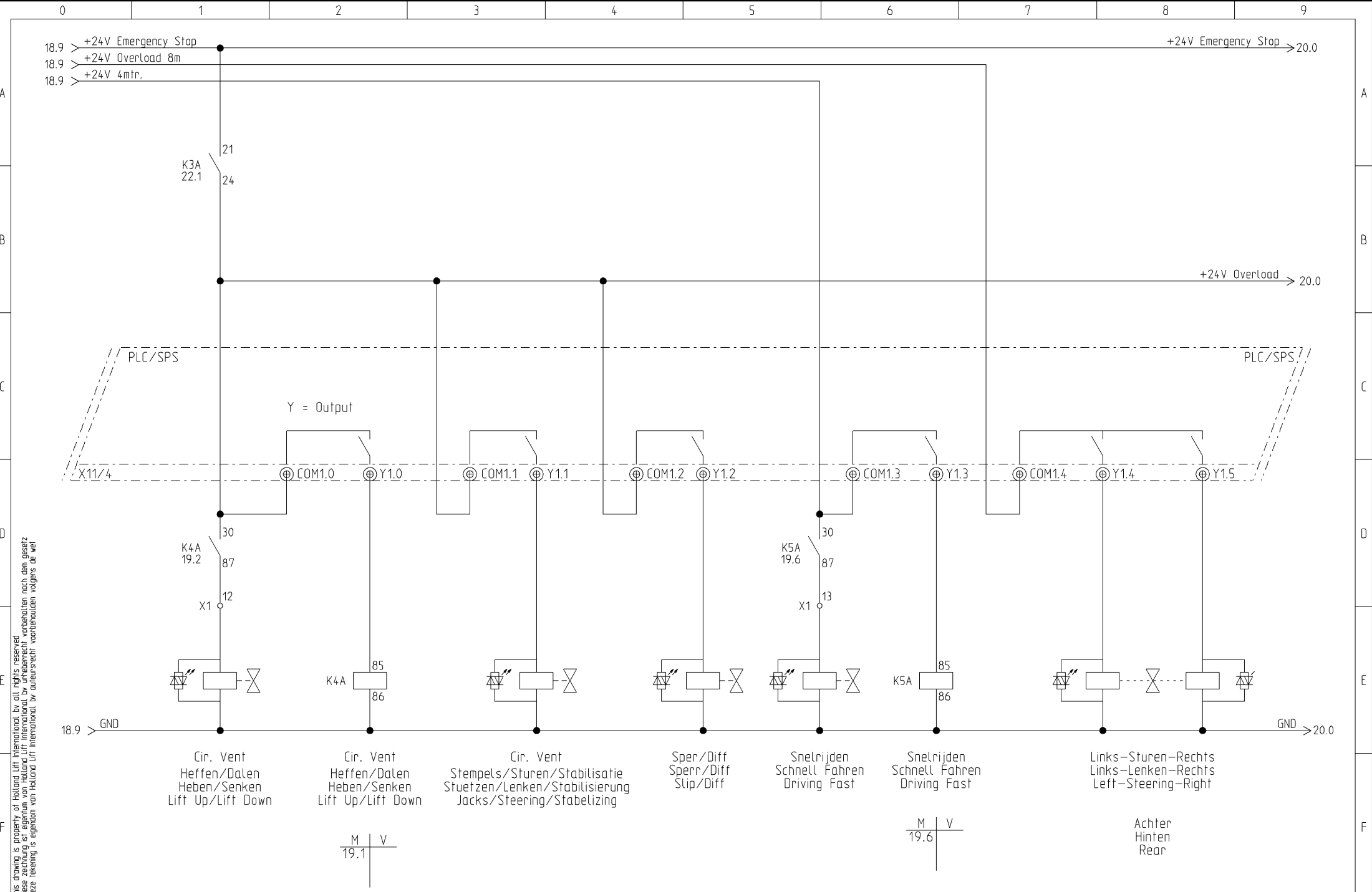

this drawing is property of Holland Lift International, by all rights reserved  
 deze tekening is eigendom van Holland Lift International, by all rights reserved  
 deze tekening is eigendom van Holland Lift International, by all rights reserved



Holland Lift International B.V.  
 Anodeweg 1  
 NL-1627 LJ Hoorn The Netherlands  
 T/F +31 (0)229-285555 / 285550  
 E service@hollandlift.com  
 W www.hollandlift.com

STROOMKRINGSCHEMA  
 STROMLAUFPLAN  
 CIRCUIT DIAGRAM

Projekt:	EN-21-001	Zeichnungsnummer:	Rev.:	erstellt von:
Datum:	22.05.2015	Anlage:	Ort:	Rothenbusch
		=	+	Blatt: 19

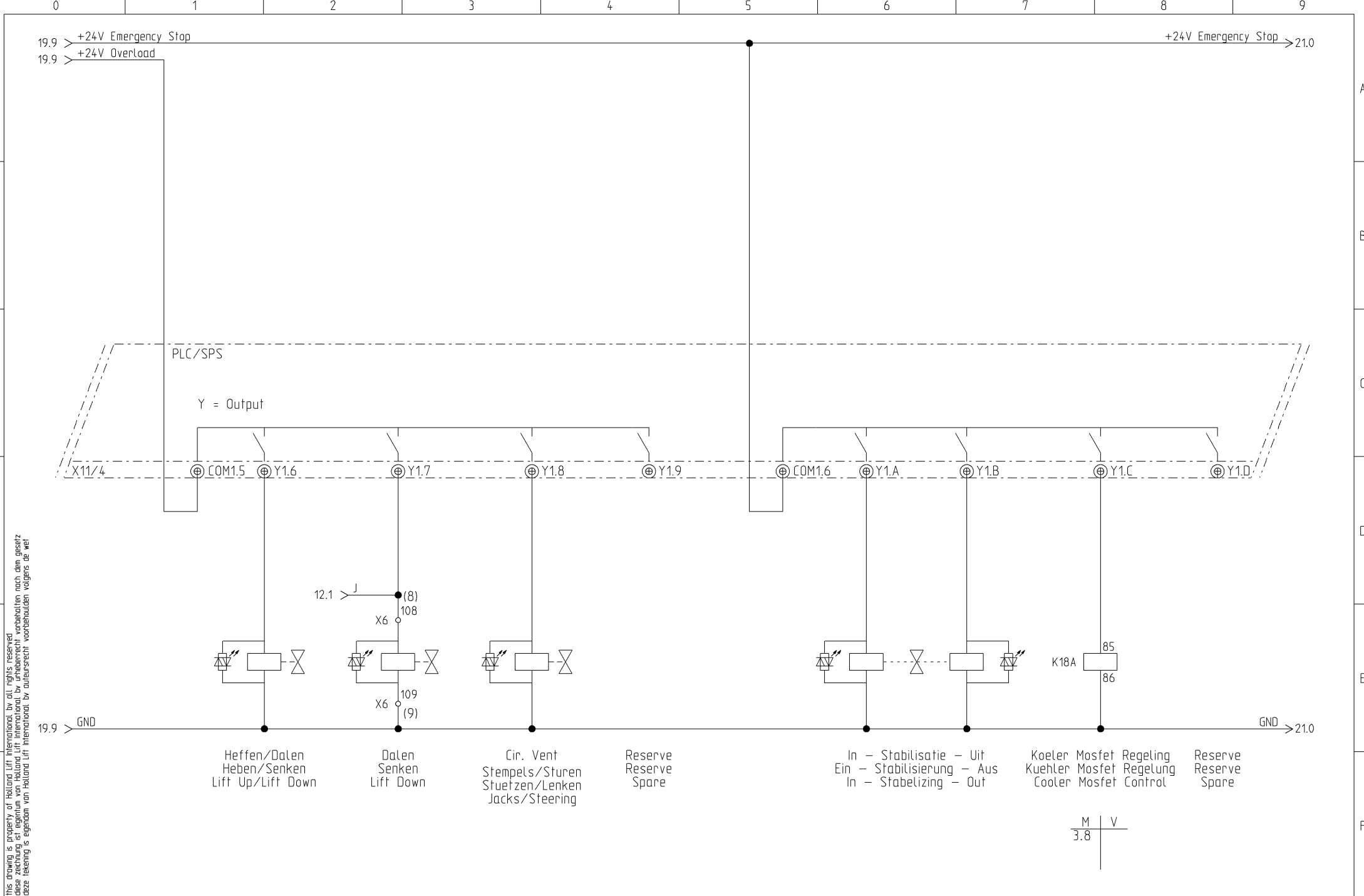

this drawing is property of Holland Lift International, by all rights reserved  
 deze tekening is eigendom van Holland Lift International, by all rights reserved  
 deze tekening is eigendom van Holland Lift International, by all rights reserved



Holland Lift International B.V.  
 Anodeweg 1  
 NL-1627 LJ Hoorn The Netherlands  
 T/F +31 (0)229-285555 / 285550  
 E service@hollandlift.com  
 W www.hollandlift.com

STROOMKRINGSCHEMA  
 STROMLAUFPLAN  
 CIRCUIT DIAGRAM

Projekt:	EN-21-001	Zeichnungsnummer:	Rev.:	erstellt von:
Datum:	22.05.2015	Anlage:	Ort:	Rothenbusch
				Blatt: 20

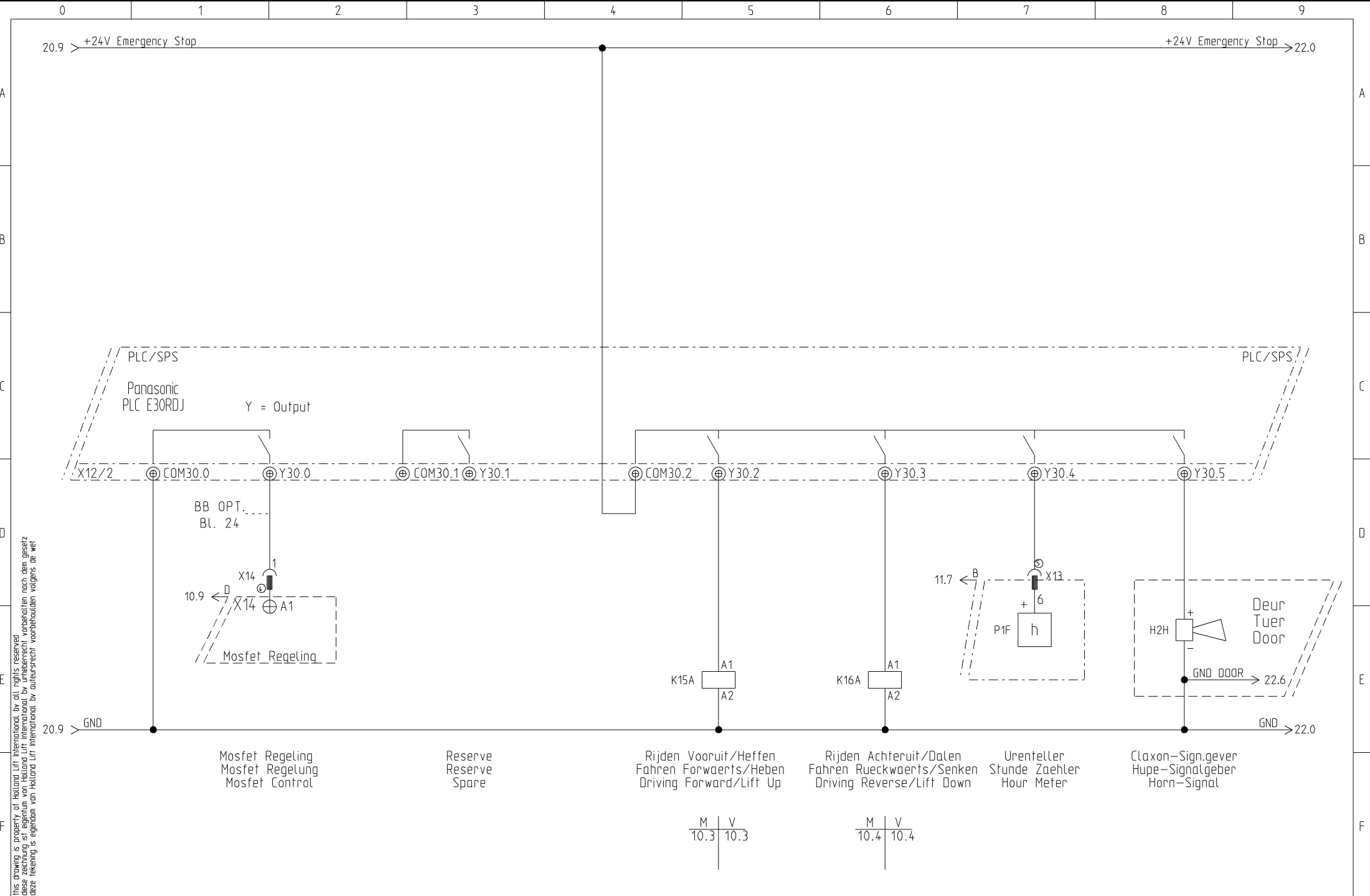

this drawing is property of Holland Lift International, by all rights reserved  
 deze tekening is eigendom van Holland Lift International, by all rights reserved  
 deze tekening is eigendom van Holland Lift International, by all rights reserved



Holland Lift International B.V.  
 Anodeweg 1  
 NL-1627 LJ Hoorn The Netherlands  
 T/F +31 (0)229-285555 / 285550  
 E service@hollandlift.com  
 W www.hollandlift.com

STROOMKRINGSHEMA  
 STROMLAUFPLAN  
 CIRCUIT DIAGRAM

Projekt:	EN-21-001	Zeichnungsnummer:	Rev.:	erstellt von:
Datum:	22.05.2015	Anlage:	Ort:	Rothenbusch
				Blatt: 21

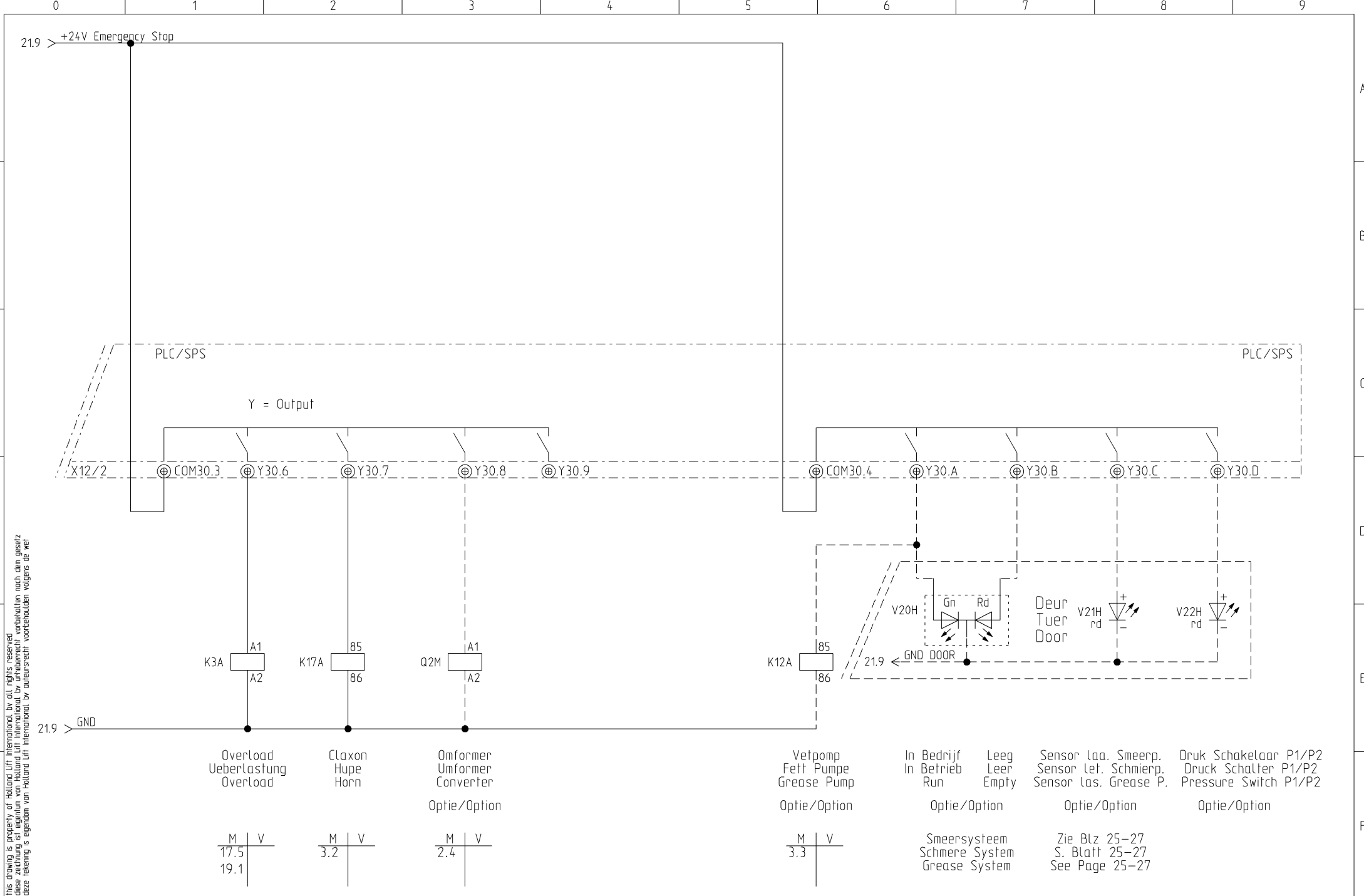

this drawing is property of Holland Lift International, by all rights reserved  
 deze tekening is eigendom van Holland Lift International, by all rights reserved  
 deze tekening is eigendom van Holland Lift International, by all rights reserved



Holland Lift International B.V.  
 Anodeweg 1  
 NL-1627 LJ Hoorn The Netherlands  
 T/F +31 (0)229-285555 / 285550  
 E service@hollandlift.com  
 W www.hollandlift.com

STROOMKRINGSCHEMA  
 STROMLAUFPLAN  
 CIRCUIT DIAGRAM

Projekt:	EN-21-001	Zeichnungsnummer:	Rev.:	erstellt von:
Datum:	22.05.2015	Anlage:	Ort:	Rothenbusch
				Blatt:
				22

OPTIES  
OPTIONEN  
OPTIONS

230V AANSLUITING PLATFORM  
230V ANSCHLUSS PLATTFORM  
230V SUPPLY PLATFORM

<230VPLF>

230V-50Hz/115V-50Hz

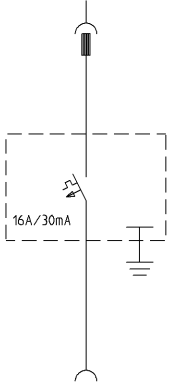

AARDLEKAUTOMAAT  
FI SCHALTER  
EARTH DETECTOR

2e HOOGTE AFLSAG  
2e HOEHE AUSSCHALTUNG  
2nd HEIGHT CUT-OUT

<2HA>

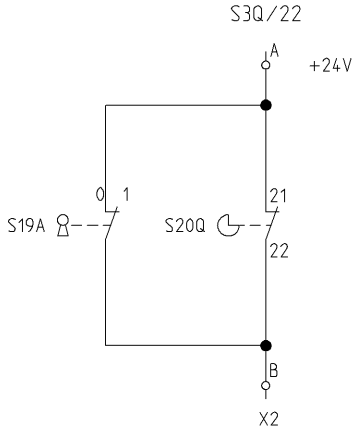

Zie Blz 11  
S. Blatt 11  
See Page 11

S19A  
0 = Max. Hoogte/Max. Hoehe/Max. Height  
1 = 2e HOOGTE AFL./2e H. AUSS./2nd H. CUT-OUT

this drawing is property of Holland Lift International, by all rights reserved  
 diese zeichnung ist eigentum von Holland Lift International, by urheberrecht vorbehalten nach dem gesetz  
 deze tekening is eigendom van Holland Lift International, by auteursrecht voorbehouden volgens de wet



Holland Lift International B.V.  
Anodeweg 1  
NL-1627 LJ Hoorn The Netherlands  
T/F +31 (0)229-285555 / 285550  
E service@hollandlift.com  
W www.hollandlift.com

OPTIES  
OPTIONEN  
OPTIONS

Projekt: EN-21-001  
Datum: 22.05.2015

Zeichnungsnummer:  
Anlage: =

Rev.:  
Ort: +

erstellt von:  
Rothenbusch  
Blatt: 23

# OPTIES OPTIONEN OPTIONS

**BELANGRIJK / WICHTIG / IMPORTANT**

BIJ TOEPASSING BLACK-BOX  
BEI BLACK-BOX  
WHEN BLACK-BOX IS USED

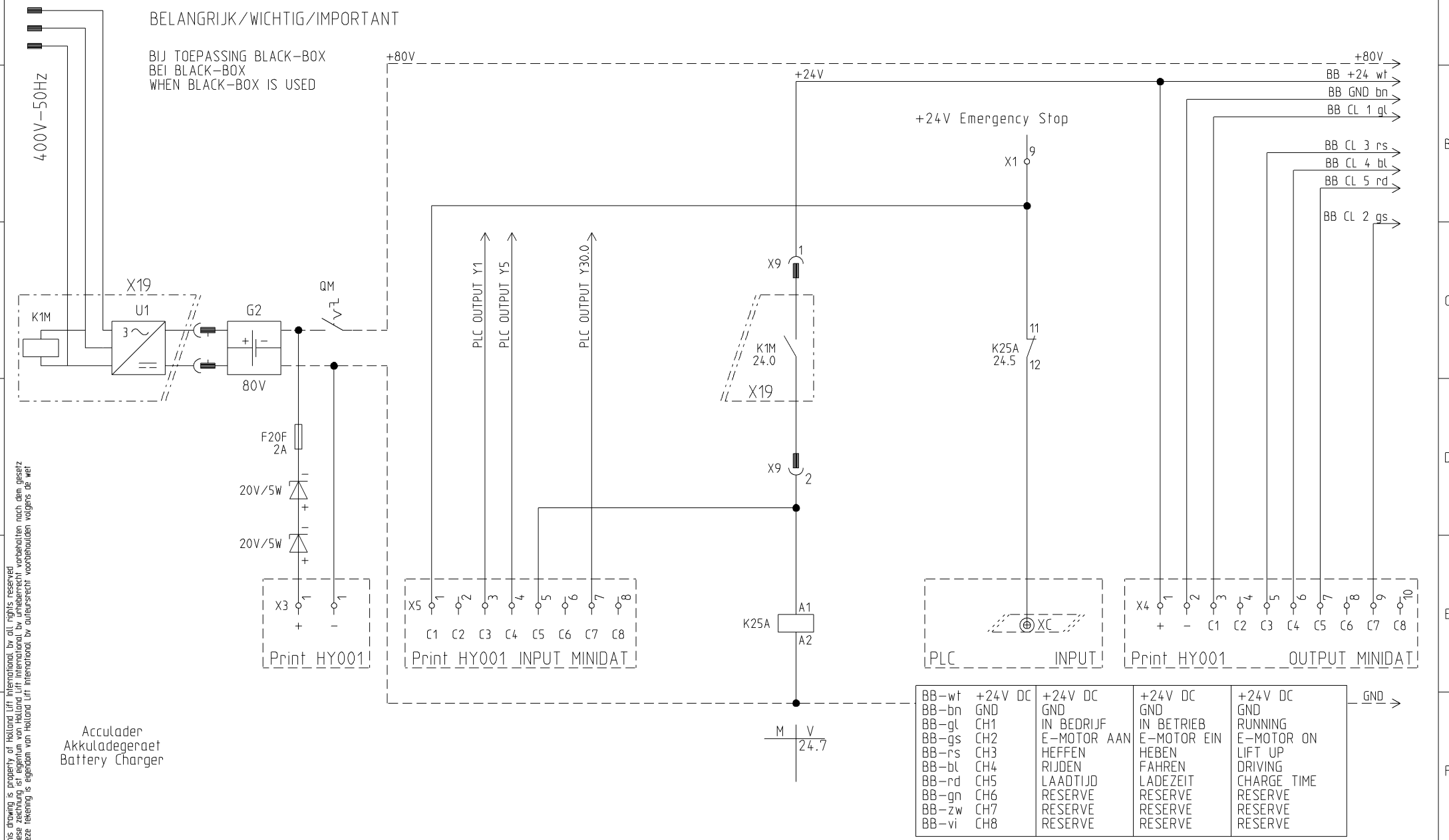

Acculader  
Akkuladegeraet  
Battery Charger

BB-wf	+24V DC	+24V DC	+24V DC	+24V DC
BB-bn	GND	GND	GND	GND
BB-gl	CH1	IN BEDRIJF	IN BETRIEB	RUNNING
BB-gs	CH2	E-MOTOR AAN	E-MOTOR EIN	E-MOTOR ON
BB-rs	CH3	HEFFEN	HEBEN	LIFT UP
BB-bl	CH4	RIJDEN	FAHREN	DRIVING
BB-rd	CH5	LAADTIJD	LADEZEIT	CHARGE TIME
BB-gn	CH6	RESERVE	RESERVE	RESERVE
BB-zw	CH7	RESERVE	RESERVE	RESERVE
BB-vi	CH8	RESERVE	RESERVE	RESERVE



OPTIES  
OPTIONEN  
OPTIONS

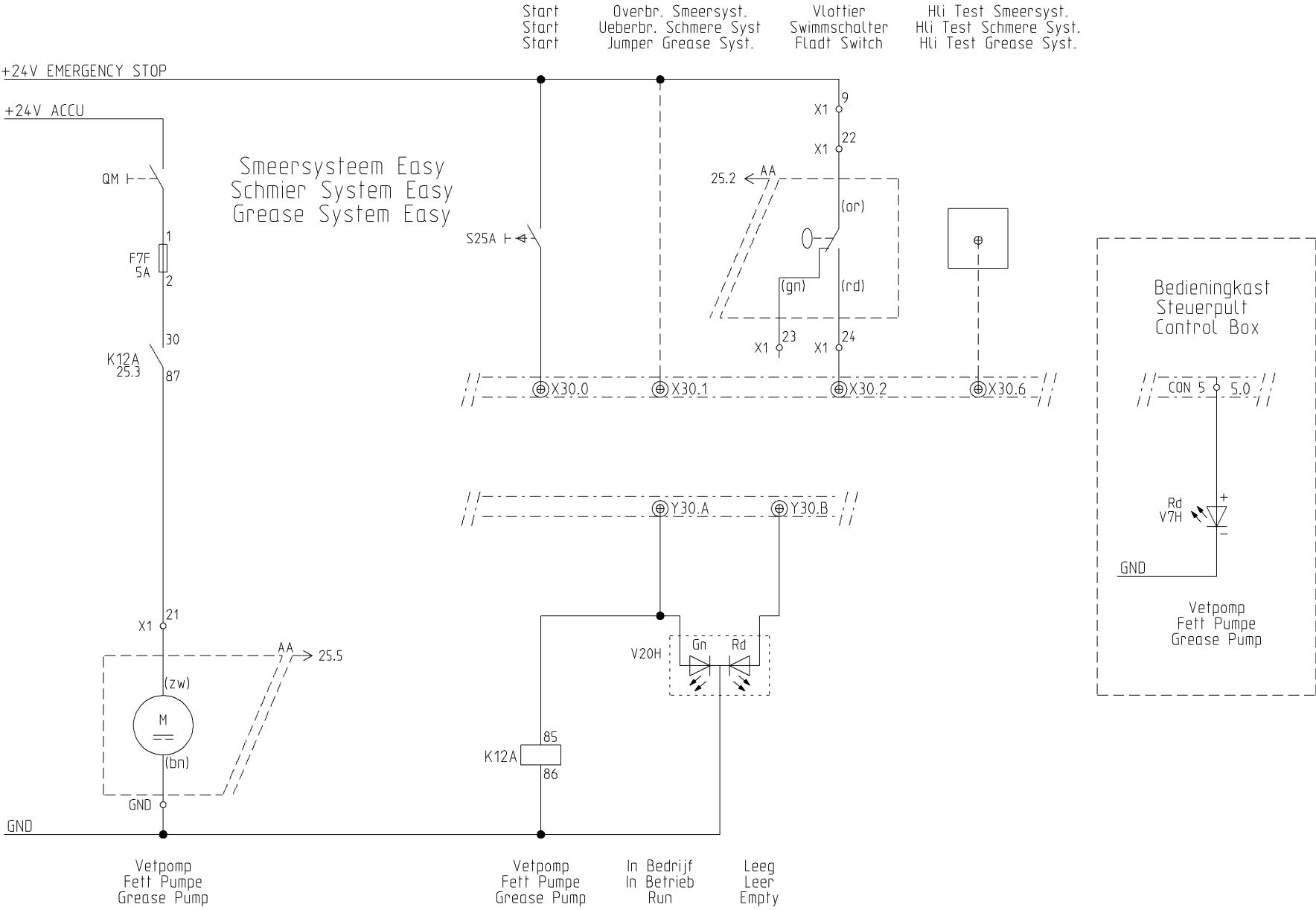

this drawing is property of Holland Lift International, by all rights reserved  
 deze tekening is eigendom van Holland Lift International, by all rights reserved  
 deze tekening is eigendom van Holland Lift International, by all rights reserved



Holland Lift International B.V.  
 Anodeweg 1  
 NL-1627 LJ Hoorn The Netherlands  
 T/F +31 (0)229-285555 / 285550  
 E service@hollandlift.com  
 W www.hollandlift.com

OPTIES  
 OPTIONEN  
 OPTIONS

Projekt:	EN-21-001	Zeichnungsnummer:	Rev.:	erstellt von:
Datum:	22.05.2015	Anlage:	Ort:	Rothenbusch
				Blatt:
				25

# OPTIES OPTIONEN OPTIONS

Start Overbr. Smeersyst. Vlottier Onderwagen P1 Schaar P2 Hli Test Smeersyst. Sensor laatste Smeerpunt  
 Start Ueberbr. Schmere Syst. Schwimmshalter Chassis P1 Schere P2 Hli Test Schmere Syst. Sensor letzter Schmierpunkt  
 Start Jumper Grease Syst. Fladt Switch Chassis P1 Scissor P2 Hli Test Grease Syst. Sensor Last Grease Point

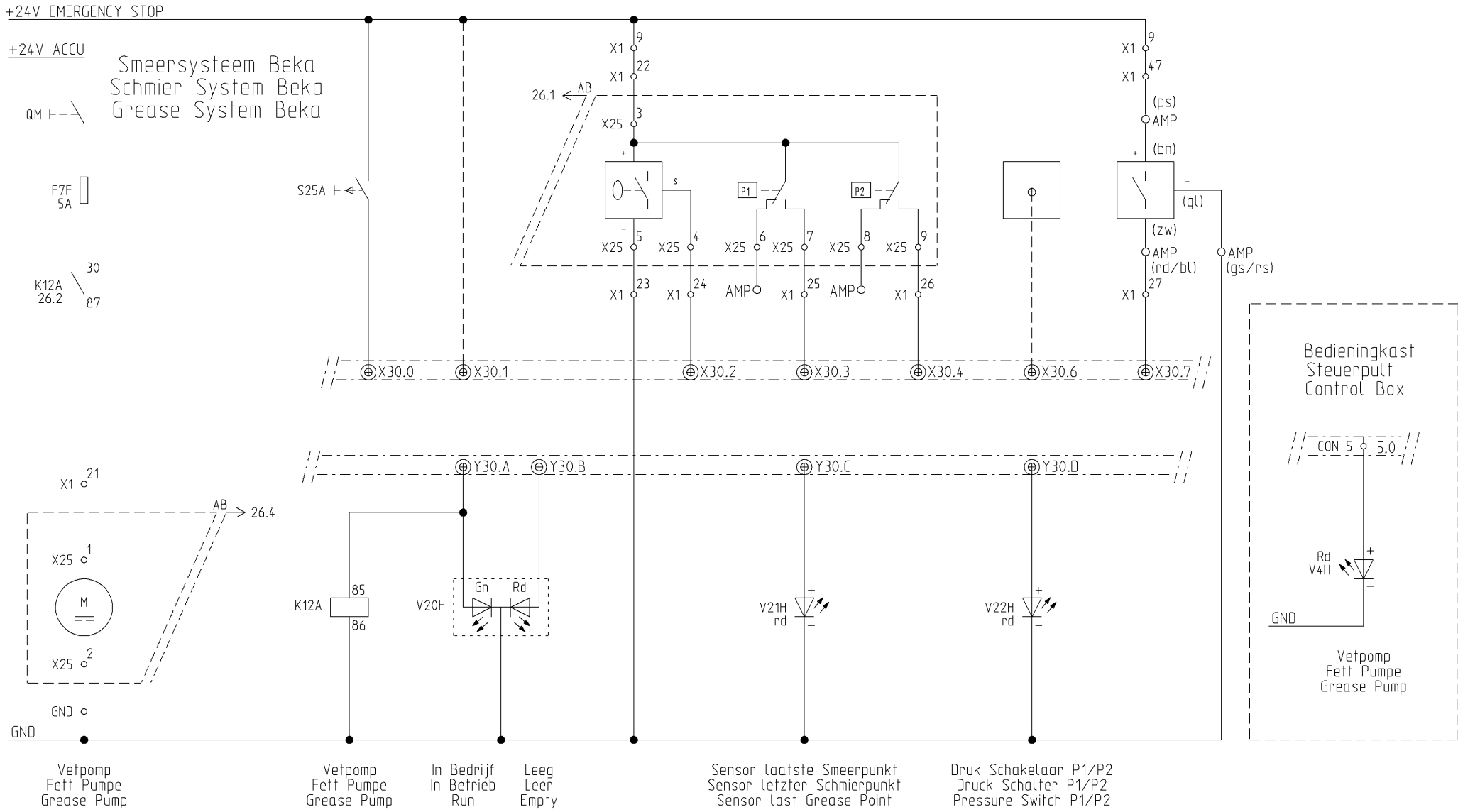

this drawing is property of Holland Lift International, by all rights reserved  
 deze tekening is eigendom van Holland Lift International, by all rights reserved  
 deze tekening is eigendom van Holland Lift International, by all rights reserved



Holland Lift International B.V.  
 Anodeweg 1  
 NL-1627 LJ Hoorn The Netherlands  
 T/F +31 (0)229-285555 / 285550  
 E service@hollandlift.com  
 W www.hollandlift.com

OPTIES  
OPTIONEN  
OPTIONS

Projekt: EN-21-001	Zeichnungsnummer:	Rev.:	erstellt von: Rothenbusch
Datum: 22.05.2015	Anlage: =	Ort: +	Blatt: 26

# OPTIES OPTIONEN OPTIONS

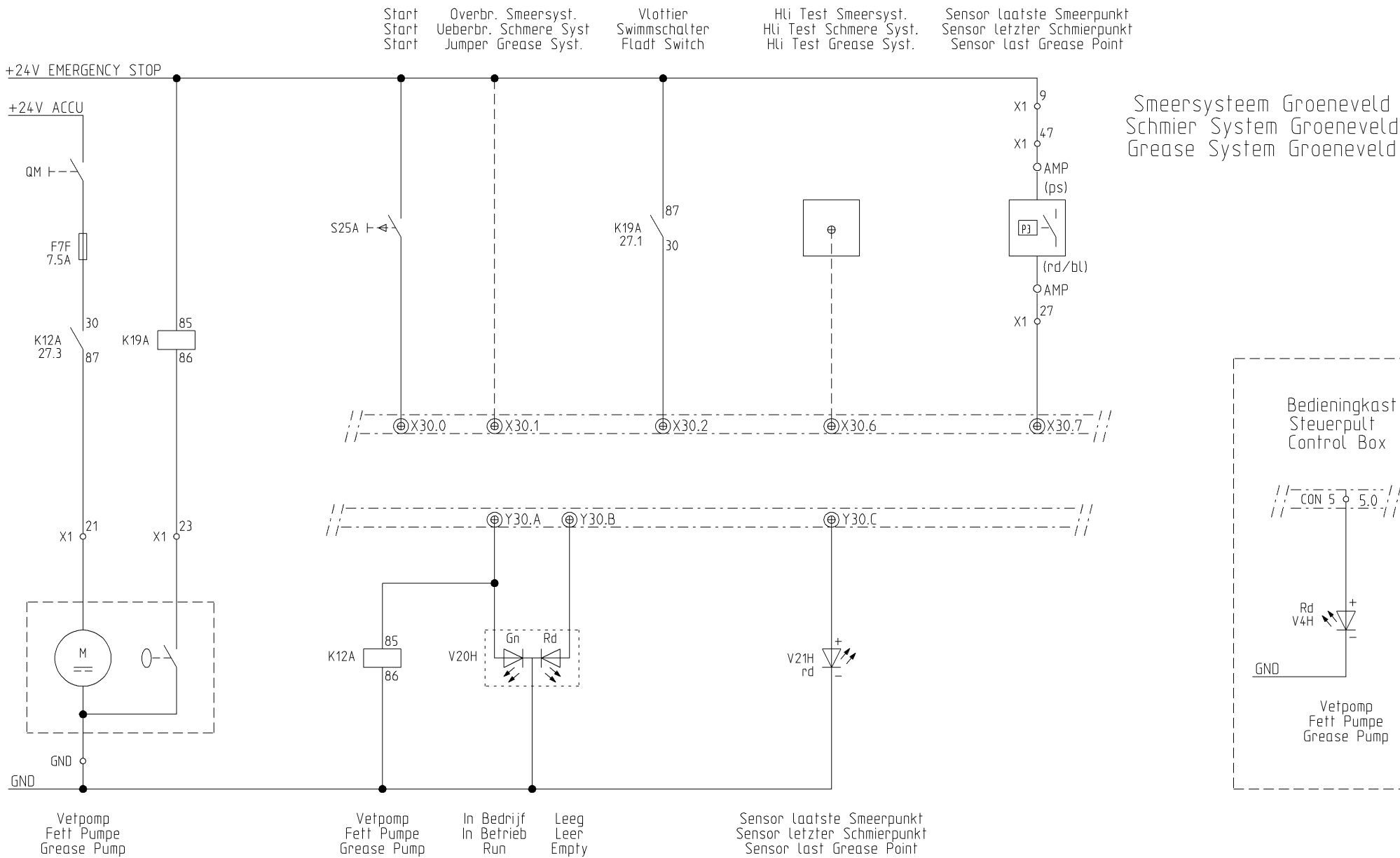

this drawing is property of Holland Lift International. By all rights reserved.  
 diese zeichnung ist eigentum von Holland Lift International. by urheberrecht vorbehalten nach dem gesetz.  
 deze tekening is eigendom van Holland Lift International. by auteursrecht voorbehouden volgens de wet.

# KLEMMENKAST KLEMMENKASTEN CONNECTION BOX

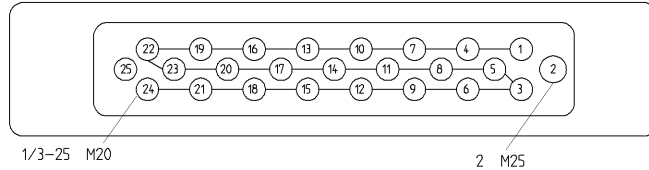

Colour schedule			
Colour	Dutch	English	Deutsch
Rd	Rood	Red	Rot
Bl	Blauw	Blue	Blau
Gt	Geel	Yellow	Gelb
Gn	Groen	Green	Gruen
Zw	Zwart	Black	Schwarz
Wt	Wit	White	Weiss
Bn	Bruin	Brown	Braun
Rs	Roze	Pink	Rosa
Or	Oranje	Orange	Orange
Ps	Paars	Violet	Violett
Tp	Transp.	Transp.	Transp.
Gs	Grijs	Grey	Grau

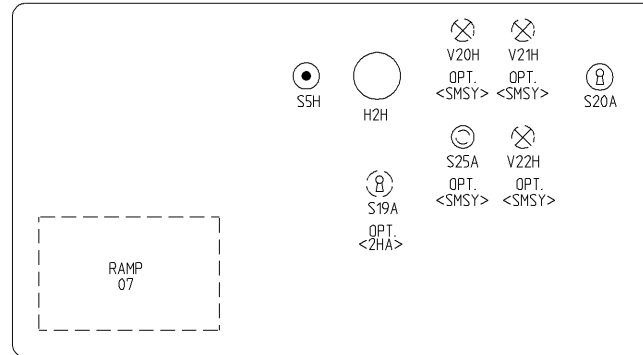
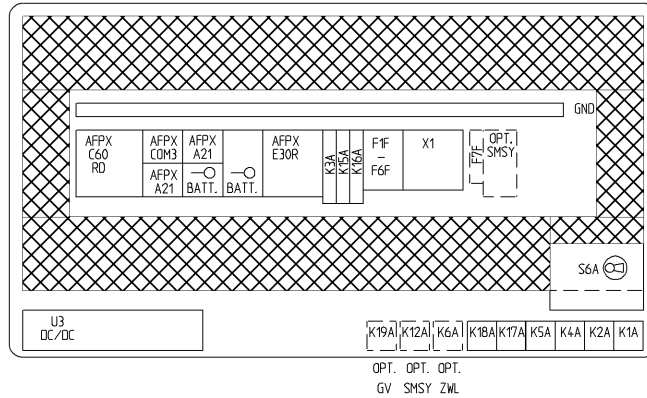

AANSLUITING OP PLATFORM  
ANSCHLUSS AUF PLATTFORM  
CONNECTION ON PLATFORM

X1

						1	2	3	8	9	9	9	10	11	12	13	14	15	4	1	4	3	4		
7	F1F 20A	F2F 5A	F3F 5A	F4F 10A	F5F 5A	F6F 7.5A	4	5	6	8	9	9	9	10	4	5	4	6	7	4	8	5	9	6	6
7							4	5	6	8	9	9	9	10	4	5	4	6	7	4	8	5	9	6	6
							1	2	3	8	9	9	9	10	11	12	13	14	15	4	1	4	3	4	

OPT.  
<SMSY>

	1	2	2	2	3	2	4
F7F 5A/7.5A	2	5	2	6	2	7	
	2	5	2	6	2	7	
	1	2	2	2	3	2	4

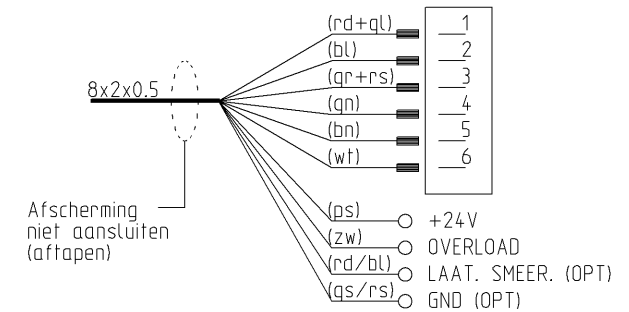

this drawing is property of Holland Lift International. by all rights reserved.  
 deze tekening is eigendom van Holland Lift International. by auteursrecht voorbehouden volgens de wet  
 deze tekening is eigendom van Holland Lift International. by auteursrecht voorbehouden volgens de wet

# HOLLAND LIFT

Holland Lift International B.V.  
Anodeweg 1  
NL-1627 LJ Hoorn The Netherlands  
T/F +31 (0)229-285555 / 285550  
E service@hollandlift.com  
W www.hollandlift.com

KASTEN/BEKABELING  
KASTEN/KABEL  
BOXES/CABLES

Projekt: EN-21-001

Zeichnungsnummer:

Rev.:

erstellt von:  
Rothenbusch

Datum: 22.05.2015

Anlage:

Ort:

Blatt: 28

# KLEMMENKAST KLEMMENKASTEN CONNECTION BOX

WARTEL KABELEINF. GLAND NR.	KLEM KLEMMEN TERMINAL NR	FUNKTIE	FUNKTION	FUNCTION
1.1	φ 9 -GND-X4	Scheefstand 1	Neigung 1	Inclination 1
1.2	DIV/VAR	Auto Niv.	Auto Niv.	Auto Niv.
1.3	φ 9 -GND-X5	Scheefstand 2	Neigung 2	Inclination 2
2	DIV/VAR	Lasdoos achter X6	Verteilerdose hinten X6	Connect. Box rear X6
3.1	AMP	Voeding +80V	Speisung +80V	Power Supply +80V
3.2	GND	Voeding GND	Speisung GND	Power Supply GND
3.3	AMP	+80V Omvormer	+80V Wandler	+80V Converter
3.4	GND	-80V Omvormer	-80V Wandler	-80V Converter
3.5	φ 7	+24V Omvormer	+24V Wandler	+24V Converter
3.6	GND	-24V Omvormer	-24V Wandler	-24V Converter
4.1	YA-GND	Stempels LA in	Stuetzen LH ein	Jacks LR in
4.2	YB-GND	Stempels LA uit	Stuetzen LH aus	Jacks LR out
5.1	YC-GND	Stempels RA in	Stuetzen RH ein	Jacks RR in
5.2	YD-GND	Stempels RA uit	Stuetzen RH aus	Jacks RR out
6.1	Y6-GND	Stempels LV in	Stuetzen LV ein	Jacks LF in
6.2	Y7-GND	Stempels LV uit	Stuetzen LV aus	Jacks LF out
7.1	Y8-GND	Stempels RV in	Stuetzen RV ein	Jacks RF in
7.2	Y9-GND	Stempels RV uit	Stuetzen RV aus	Jacks RF out
8.1	DIV/VAR	Lasdoos voor X7	Verteilerdose vorn X7	Connect. Box front X7
8.2	DIV/VAR	Mosfet Motorreg.	Mosfet Motorreg.	Mosfet Motor Con.
9.1	Y1.2-GND	Sper/Diff. Ventiel	Sperr/Diff. Ventil	Slip/Diff. Valve
9.2	φ 13 -GND	Snelrijden	Schnell Fahren	Driving Fast
10.1	Y1.1-GND	Cir. Ve. Stu.-Pla.-Ste.	Cir. Ve. Len.-Sta.-Stu.	Cir. Va. Ste.-Sta.-Jac.
10.2	Y1.6-GND	Heffen/Dalen	Heben/Senken	Lift Up/Lift Down
11.1	Y5-GND	Rem Achter	Bremse Hinten	Brake Rear
11.2	Y4-GND	Rem Voor	Bremse Vorn	Brake Front
12.1	Y1.8-GND	Cir. Ventiel Stempels	Cir. Ventil Stuetzen	Cir. Valve Jacks
12.2	φ 12 -GND	Cir. Heffen/Dalen	Cir. Heben/Senken	Cir. Lift Up/Lift Down
13.1	Y2-GND	Sturen Links Voor	Lenken Links Vorn	Steering Left Front
13.2	Y3-GND	Sturen Rechts Voor	Lenken Rechts Vorn	Steering Right Front
14.1	Y1.4-GND	Sturen Links Achter	Lenken Links Hinten	Steering Left Rear
14.2	Y1.5-GND	Sturen Rechts Achter	Lenken Rechts Hinten	Steering Right Rear
15.1	Y1.A-GND	Stabilisatie In	Stabilisierung Ein	Stabelizing In
15.2	Y1.B-GND	Stabilisatie Uit	Stabilisierung Aus	Stabelizing Out

WARTEL KABELEINF. GLAND NR.	KLEM KLEMMEN TERMINAL NR	FUNKTIE	FUNKTION	FUNCTION
16.1	φ 11 -GND	Cir. Heffen	Cir. Heben	Cir. Lift Up
16.2	φ 14 -GND	Claxon	Horn	Horn
16.3	Y30.8-GND	Relais Omformer Opt.	Relais Umformer Opt.	Relais Converter Opt.
17.1	φ 58 -φ 59	Prop. Ventiel A	Prop. Ventil A	Prop. Valve A
17.2	φ 60 -φ 61	Prop. Ventiel B	Prop. Ventil B	Prop. Valve B
18.1	φ 10 -X1.6	Temp. Hd. Olie	Temp. Hd. Oel	Temp. Hd. Oil
18.2	φ 10 -X1.0	Lage Druk	Niedriger Druck	Low Pressure
19.1	φ 9 -XD	Stabilisatie Links Uit	Stabilisierung Links Aus	Stabelizing Left Out
19.2	φ 9 -XE	Stabilisatie Rechts Uit	Stabilisierung Rechts Aus	Stabelizing Right Out
20	DIV/VAR	WCD Onderwagen 6PM	WCD Unterwagen 6PM	Socket Below 6PM
21	DIV/VAR	WCD Platform 6PM	WCD Plattform 6PM	Socket Platform 6PM
22	DIV/VAR	Stekker Onderw. 6PF	Stecker Unterw. 6PF	Plug Below 6PF
23.1	DIV/VAR	Smeersysteem Opt.	Schmiere System Opt.	Grease System Opt.
23.2	DIV/VAR	Black-Box Optie	Black-Box Option	Black-Box Option
24.1	DIV/VAR	Accumeter	Akkumeter	Batterymeter
24.2	DIV/VAR	Acculader	Akkuladegeraet	Battery Charger
25.1	φ 15 -GND	Ventilator Mosfet	Ventilator Mosfet	Fan Mosfet
25.2	φ 9 -X30.D	As Hor. Achter	Achse Hor. Hinten	Axle Hor. Rear
25.3	φ 9 -X30.C	As Hor. Voor Opt.	Achse Hor. Vorne Opt.	Axle Hor. Front Opt.
26.1	Y0-GND	Zwaailamp Opt.	Blitzleuchte Opt.	Flashlight Opt.
26.2	Y0-GND	Zwaailamp Opt.	Blitzleuchte Opt.	Flashlight Opt.

this drawing is property of Holland Lift International, by all rights reserved  
 diese zeichnung ist eigentum von Holland Lift International, by alle rechte vorbehalten  
 deze tekening is eigendom van Holland Lift International, by auteursrecht voorbehouden volgens de wet

# HOLLAND LIFT

Holland Lift International B.V.  
 Anodeweg 1  
 NL-1627 LJ Hoorn The Netherlands  
 T/F +31 (0)229-285555 / 285550  
 E service@hollandlift.com  
 W www.hollandlift.com

KASTEN/BEKABELING  
 KASTEN/KABEL  
 BOXES/CABLES

Projekt:	EN-21-001	Zeichnungsnummer:	Rev.:	erstellt von:
Datum:	22.05.2015	Anlage:	Ort:	Rothenbusch
		=	+	Blatt: 29

LASDOOS AFSLAGEN  
 VERTEILERDOSE HOEHEAUSSCHALTUNG  
 MAXIMUM HEIGHT DISTRBUOR BOX

LASDOOS ACHTER  
 VERTEILERDOSE HINTEN  
 DISTRBUOR BOX REAR

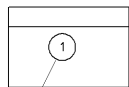
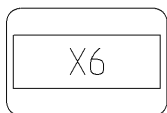

M25

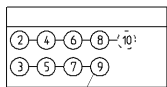

2-10 M12

OPT.  
 <2HA>

X6

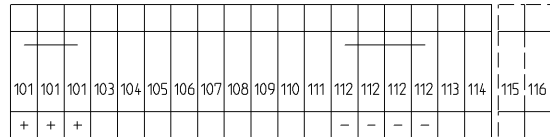

F5F

NR.	Omschrijving	Beschreibung	Descreption
1	Kabel Klemmenkast	Kabel Klemmenkasten	Cable Connection Box
2	4mtr. Afslag S1Q	4mtr. Ausschaltung S1Q	4mtr. Cut-out S1Q
3	8mtr. Afslag S2Q	8mtr. Ausschaltung S2Q	8mtr. Cut-out S2Q
4	Max. Hooqte Afslag S3Q	Max. Hoehe Ausschaltung S3Q	Max. Height Cut-out S3Q
5	Dalen	Senken	Lift Down
6	Eindschak. LA in S9Q	Endschalter LH ein S9Q	Limit Switch LR in S9Q
7	Eindschak. LA uit S13Q	Endschalter LH aus S13Q	Limit Switch LR out S13Q
8	Eindschak. RA in S10Q	Endschalter RH ein S10Q	Limit Switch RR in S10Q
9	Eindschak. RA uit S14Q	Endschalter RH aus S14Q	Limit Switch RR out S14Q
10	2e hooqte Afslag Optie	2e hoehe Ausschtung Option	2nd height cut-out Option

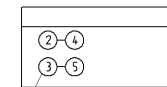
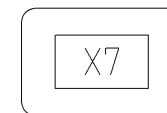

2-5 M12

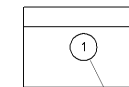

M20

X7

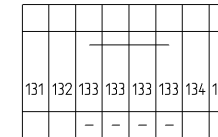

F5F

NR.	Omschrijving	Beschreibung	Descreption
1	Kabel Klemmenkast	Kabel Klemmenkasten	Cable Connection Box
2	Eindschak. LV in S11Q	Endschalter LV ein S11A	Limit Switch LF in S11Q
3	Eindschak. LV uit S15Q	Endschalter LV aus S15Q	Limit Switch LF out S15Q
4	Eindschak. RV in S12Q	Endschalter RV ein S12Q	Limit Switch RF in S12Q
5	Eindschak. RV uit S16Q	Endschalter RV aus S16Q	Limit Switch RF out S16Q

this drawing is property of Holland Lift International, by all rights reserved.  
 diese zeichnung ist eigentum von Holland Lift International, by alle rechte vorbehalten nach dem gesetz.  
 deze tekening is eigendom van Holland Lift International, by auteursrecht voorbehouden volgens de wet

**HOLLAND LIFT**

Holland Lift International B.V.  
 Anodeweg 1  
 NL-1627 LJ Hoorn The Netherlands  
 T/F +31 (0)229-285555 / 285550  
 E service@hollandlift.com  
 W www.hollandlift.com

KASTEN/BEKABELIN  
 KASTEN/KABEL  
 BOXES/CABLES

Projekt:	EN-21-001	Zeichnungsnummer:	Rev.:	erstellt von:
Datum:	22.05.2015	Anlage:	Ort:	Rothenbusch
		=	+	Blatt: 30

# BEDIENINGSKAST STEUERPULT CONTROL BOX

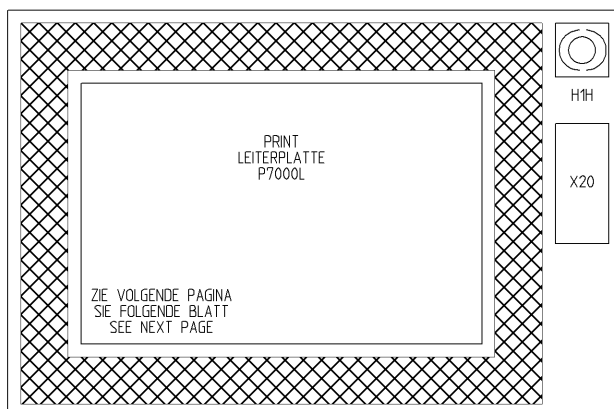
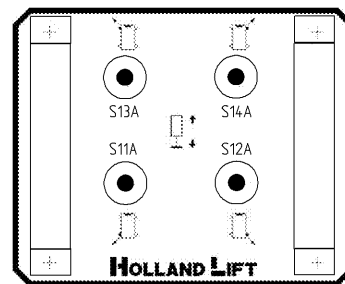
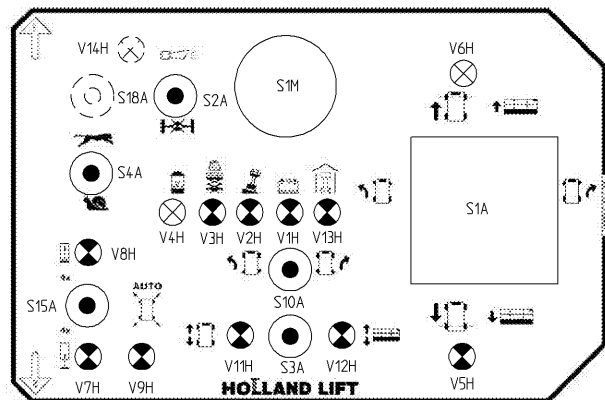

Colour schedule			
Colour	Dutch	English	Deutsch
Rd	Rood	Red	Rot
Bl	Blauw	Blue	Blau
Gl	Geel	Yellow	Gelb
Gn	Groen	Green	Gruen
Zw	Zwart	Black	Schwarz
Wt	Wit	White	Weiss
Bn	Bruin	Brown	Braun
Rs	Roze	Pink	Rosa
Or	Oranje	Orange	Orange
Ps	Poars	Violet	Violett
Tp	Transp.	Transp.	Transp.
Gs	Grijs	Grey	Grau

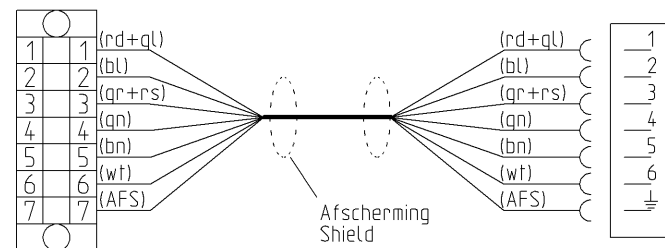
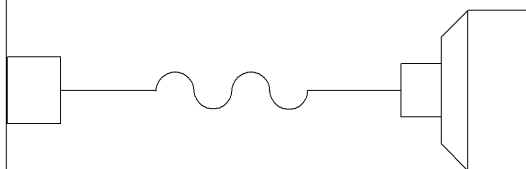

this drawing is property of Holland Lift International, by all rights reserved  
 deze tekening is eigendom van Holland Lift International, by auteursrecht voorbehouden volgens de wet  
 deze tekening is eigendom van Holland Lift International, by auteursrecht voorbehouden volgens de wet

# HOLLAND LIFT

Holland Lift International B.V.  
 Anodeweg 1  
 NL-1627 LJ Hoorn The Netherlands  
 T/F +31 (0)229-285555 / 285550  
 E service@hollandlift.com  
 W www.hollandlift.com

KASTEN/BEKABELING  
 KASTEN/KABEL  
 BOXES/CABLES

Projekt: EN-21-001

Zeichnungsnummer:

Rev.:

erstellt von:  
 Rothenbusch

Datum: 22.05.2015

Anlage:

Ort:

Blatt: 31

PRINTPLAAT  
LEITERPLATTE  
CIRCUIT BOARD

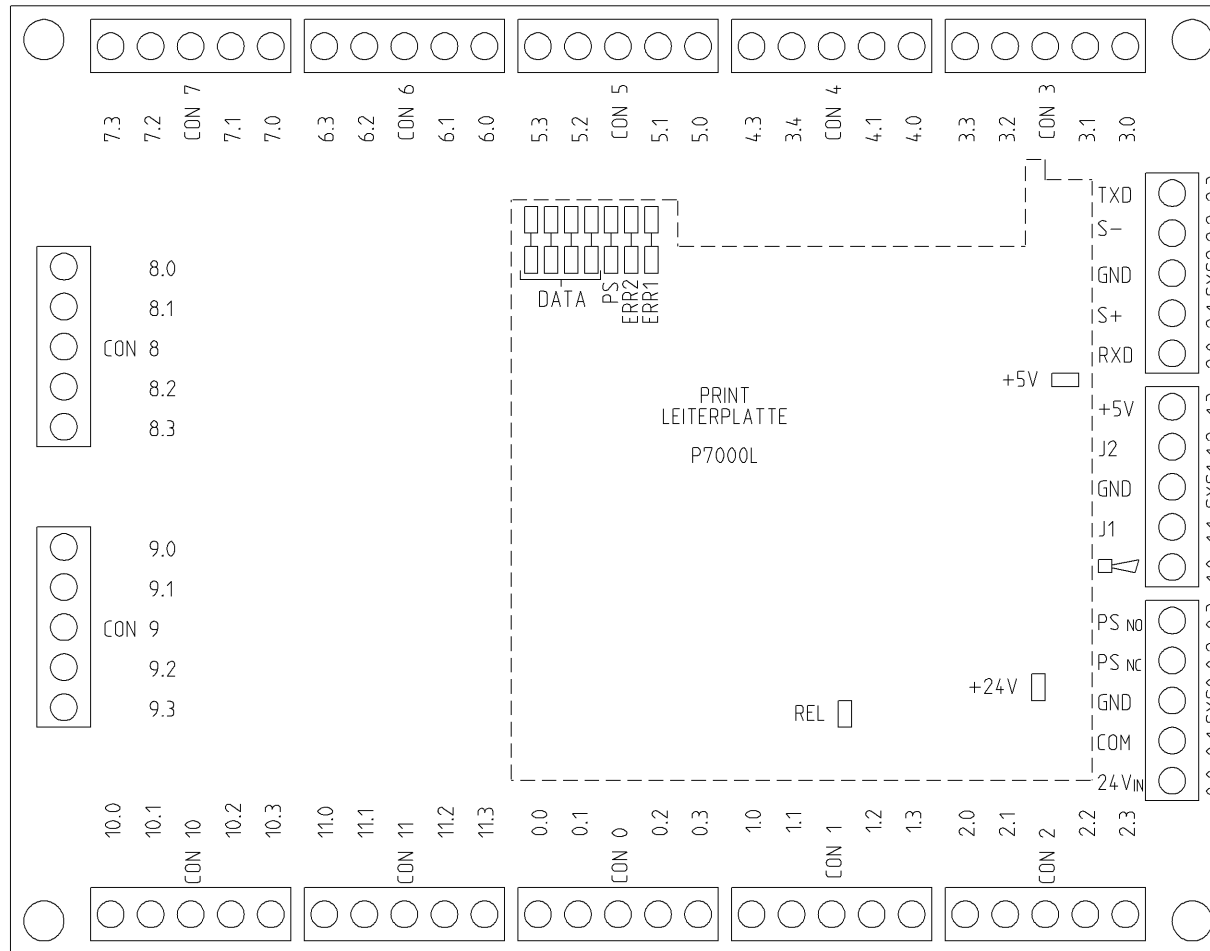

+24V	<input type="checkbox"/>	Groen/Gruen/Green	Voeding Ok	Speisung Ok	Supply Ok
+5V	<input type="checkbox"/>	Groen/Gruen/Green	Voeding Ok	Speisung Ok	Supply Ok
REL	<input type="checkbox"/>	Groen/Gruen/Green	Power Safe aan	Power Safe an	Power Safe on
PS	<input type="checkbox"/>	Geel/Gelb/Yellow	Power Safe uit	Power Safe aus	Power Safe off
Err1	<input type="checkbox"/>	Geel/Gelb/Yellow	Slechte Data Verbinding	Schlechte Data Verbindung	Poor Data Connection
Err2	<input type="checkbox"/>	Rood/Rot/Red	Geen Data Verbinding	Keine Data Verbindung	No Data Connection

this drawing is property of Holland Lift International, by all rights reserved.  
 diese zeichnung ist eigentum von Holland Lift International, by urheberrecht vorbehalten nach dem gesetz.  
 deze tekening is eigendom van Holland Lift International, by auteursrecht voorbehouden volgens de wet.

# HOLLAND LIFT

Holland Lift International B.V.  
 Anodeweg 1  
 NL-1627 LJ Hoorn The Netherlands  
 T/F +31 (0)229-285555 / 285550  
 E service@hollandlift.com  
 W www.hollandlift.com

PRINTPLAAT  
LEITERPLATTE  
CIRCUIT BOARD

Projekt: EN-21-001

Zeichnungsnummer:

Rev.:

erstellt von:  
Rothenbusch

Datum: 22.05.2015

Anlage:

Ort:

Blatt: 32



this drawing is property of Holland Lift International, by all rights reserved  
 deze tekening is eigendom van Holland Lift International, by all rights reserved  
 deze tekening is eigendom van Holland Lift International, by auteursrecht voorbehouden volgens de wet

0.0	Joystick Op (S1A2)	Fahren Joy. Auf (S1A2)	Joystick On (S1A2)
0.1	Joystick Neer (S1A3)	Fahren Joy. Nied. (S1A3)	Joystick Down (S1A3)
CON 0			
0.2	Sturen Links (S1A4)	Lenken Links (S1A4)	Steering Left (S1A4)
0.3	Sturen Rechts (S1A5)	Lenken Rechts (S1A5)	Steering Right (S1A5)

1.0	Claxon (S2A3)	Hupe (S2A3)	Horn (S2A3)
1.1	Sper/Diff. (S2A1)	Sperr/Diff. (S2A1)	Slip/Diff. (S2A1)
CON 1			
1.2	Heffen/Dalen (S3A1)	Heben/Senken (S3A1)	Lift Up/Down (S3A1)
1.3	Rijden/Sturen (S3A3)	Fahren/Lenken (S3A3)	Driving/Steering (S3A3)

2.0	Snel Rijden (S4A)	Schnell Fahren (S4A)	Driving Fast (S4A)
2.1	Reserve	Reserve	Spare
CON 2			
2.2	Reserve	Reserve	Spare
2.3	Dodemansknop (S1A1)	Totmansknopf (S1A1)	Dead Man (S1A1)

0.0	Voeding +24V (S1M)	Speisung +24V (S1M)	Supply +24V (S1M)
0.1	Voeding +24V (S1M)	Speisung +24V (S1M)	Supply +24V (S1M)
SYS0 GND	GND	GND	GND
0.2	Reserve	Reserve	Spare
0.3	Voeding +24V (PS)	Speisung +24V (PS)	Supply +24V (PS)

1.0	+ Zoemer (H1H)	+ Summer (H1H)	+ Buzzer (H1H)
1.1	0-5V Joystick P1	0-5V Joystick P1	0-5V Joystick P1
SYS1 GND	- Zoemer (H1H)	- Summer (H1H)	- Buzzer (H1H)
1.2	Reserve (0-5V)	Reserve (0-5V)	Spare (0-5V)
1.3	Voeding +5V Joy. (P1)	Speisung +5V Joy. (P1)	Supply +5V Joy. (P1)

2.0	Data RXD	Data RXD	Data RXD
2.1	Data S+ (RS485)	Data S+ (RS485)	Data S+ (RS485)
SYS2 GND	Reserve	Reserve	Spare
2.2	Data S- (RS485)	Data S- (RS485)	Data S- (RS485)
2.3	Data TXD	Data TXD	Data TXD

3.0	Sturen LA (S10A1)	Lenken LH (S10A1)	Steering LR (S10A1)
3.1	Sturen RA (S10A3)	Lenken RH (S10A3)	Steering RR (S10A3)
CON 3			
3.2	4x Stempels in (S15A1)	4x Stuetzen ein (S15A1)	4x Jacks in (S15A1)
3.3	4x uit Au. Niv. (S15A3)	4x aus Au. Niv. (S15A3)	4x out Au. Niv.(S15A3)

4.0	Reserve	Reserve	Spare
4.1	Reserve	Reserve	Spare
CON 4			
4.2	Achteras recht (V5H)	Hintera. gerade (V5H)	Rear A. straight (V5H)
4.3	VA. recht OPT. (V6H)	VA. gerade OPT. (V6H)	FA. straight OPT. (V6H)

5.0	Vetpomp Opt. (V4H)	Fett Pumpe Opt. (V4H)	Grease Pu. Opt. (V4H)
5.1	Overload (V3H)	Ueberlastung (V3H)	Overload (V3H)
CON 5			
5.2	Scheefstand (V2H)	Neigung (V2H)	Inclination (V2H)
5.3	Accu leeg (V1H)	Akku leer (V1H)	Battery empty (V1H)

6.0	Reserve	Reserve	Spare
6.1	Reserve	Reserve	Spare
CON 6			
6.2	Om. aan Opt. (S18A1)	Um. an Opt. (S18A1)	Co. on Opt. (S18A1)
6.3	Om. uit Opt. (S18A3)	Um. aus Opt. (S18A3)	Co. off Opt. (S18A3)

7.0	Stempels LA in (S13A1)	Stuetzen LH ein (S13A1)	Jacks LR in (S13A1)
7.1	Stemp. LA uit (S13A3)	Stuetzen LH aus (S13A3)	Jacks LR out (S13A3)
CON 7			
7.2	Stempels RA in (S14A1)	Stuetzen RH ein (S14A1)	Jacks RR in (S14A1)
7.3	Stemp. RA uit (S14A3)	Stuetzen RH aus (S14A3)	Jacks RR out (S14A3)

8.0	Stempels LV in (S11A1)	Stuetzen LV ein (S11A1)	Jacks LF in (S11A1)
8.1	Stemp. LV uit (S11A3)	Stuetzen LV aus (S11A3)	Jacks LF out (S11A3)
CON 8			
8.2	Stempels RV in (S12A1)	Stuetzen RV ein (S12A1)	Jacks RF in (S12A1)
8.3	Stemp. RV uit (S12A3)	Stuetzen RV aus (S12A3)	Jacks RF out (S12A3)

9.0	Reserve	Reserve	Spare
9.1	Stempels in (V8H)	Stuetzen ein (V8H)	Jacks in (V8H)
CON 9			
9.2	Stempels uit (V7H)	Stuetzen aus (V7H)	Jacks out (V7H)
9.3	Auto Niv. (V9H)	Auto Niv. (V9H)	Auto Niv. (V9H)

10.0	Reserve	Reserve	Spare
10.1	Reserve	Reserve	Spare
CON 10			
10.2	Reserve	Reserve	Spare
10.3	Reserve	Reserve	Spare

11.0	Rijden/Sturen (V11H)	Fahren/Lenken (V11H)	Driving/Steering (V11H)
11.1	Heffen/Dalen (V12H)	Heben/Senken (V12H)	Lift Up/Down (V12H)
CON 11			
11.2	Alleen binnen (V13H)	Nur Innenräumen (V13H)	Inside use only (V13H)
11.3	Om. aan Opt. (V14H)	Um. an Opt. (V14H)	Co. on Opt. (V14H)



Holland Lift International B.V.  
 Anodeweg 1  
 NL-1627 LJ Hoorn The Netherlands  
 T/F +31 (0)229-285555 / 285550  
 E service@hollandlift.com  
 W www.hollandlift.com

PRINTPLAAT  
 LEITERPLATTE  
 CIRCUIT BOARD

Projekt:	EN-21-001	Zeichnungsnummer:	Rev.:	erstellt von:
Datum:	22.05.2015	Antlage:	Ort:	Rothenbusch
		=	+	Blatt: 33