

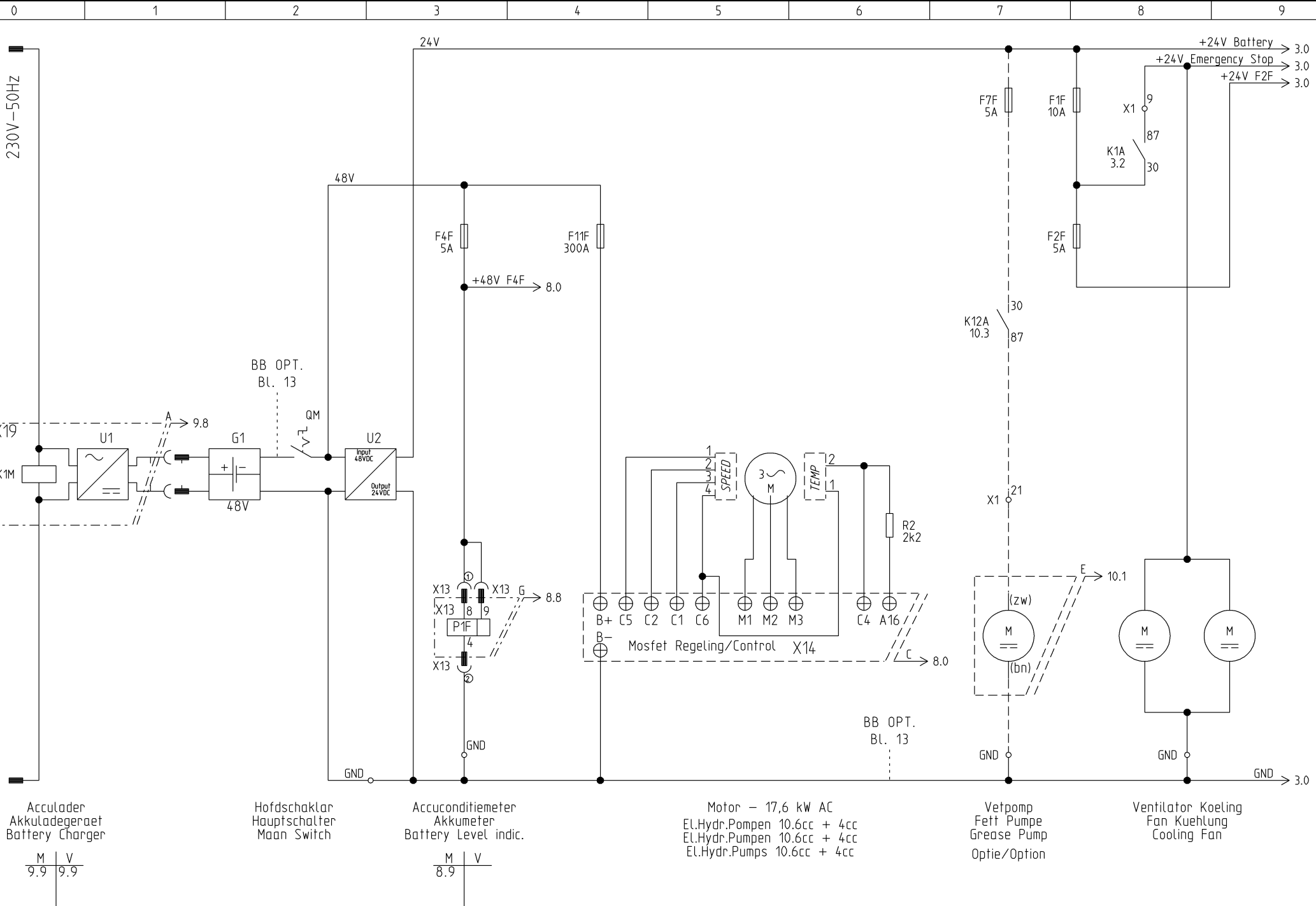

This drawing is property of Holland Lift International, by all rights reserved.  
 deze tekening is eigendom van Holland Lift International, by all rights reserved.  
 deze tekening is eigendom van Holland Lift International, by all rights reserved.



Acculader  
Akkuladegeraet  
Battery Charger

M	V
9.9	9.9

Hofdschaklar  
Hauptschalter  
Maan Switch

Accuconditiemeter  
Akkumeter  
Battery Level indic.

M	V
8.9	

Motor - 17,6 kW AC  
El.Hydr.Pompen 10.6cc + 4cc  
El.Hydr.Pumpen 10.6cc + 4cc  
El.Hydr.Pumps 10.6cc + 4cc

Vetpomp  
Fett Pumpe  
Grease Pump  
Optie/Option

Ventilator Koeling  
Fan Kuehlung  
Cooling Fan

This drawing is property of Holland Lift International. All rights reserved.  
 deze tekening is eigendom van Holland Lift International. Alle rechten voorbehouden volgens de wet

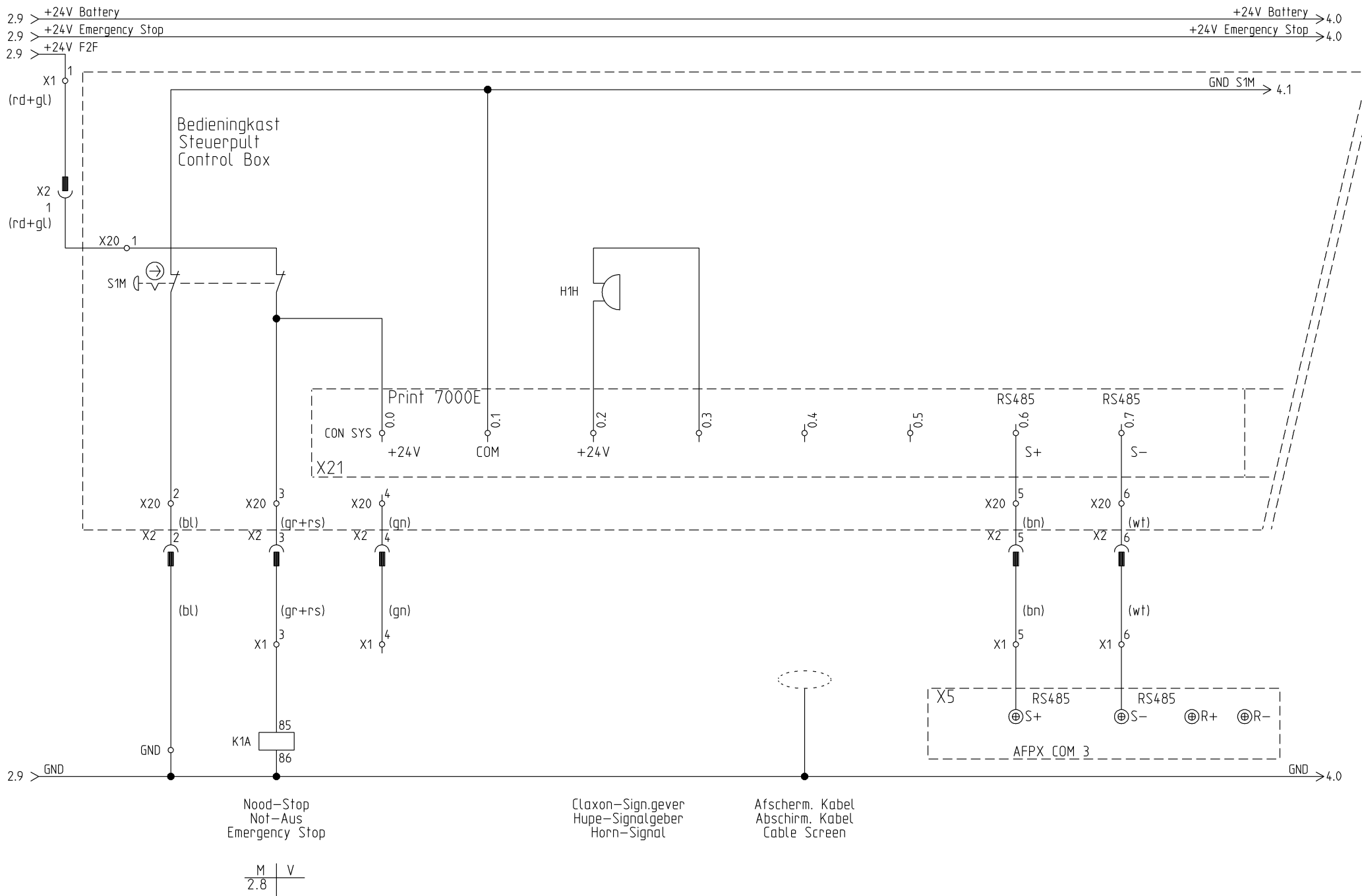

3.9 > +24V Battery  
 3.9 > +24V Emergency Stop

+24V Battery > 5.0  
 +24V Emergency Stop > 5.0

3.9 > GND S1M

GND S1M > 5.1

Bedieningkast  
 Steuerpult  
 Control Box

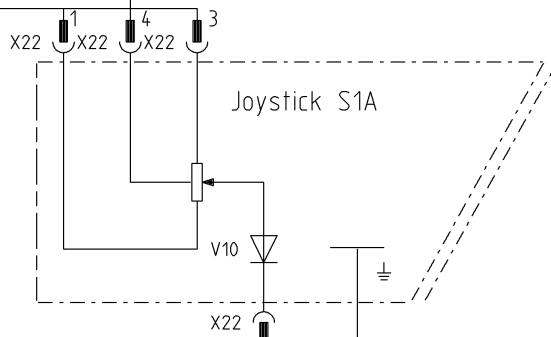

CON A 0.0  
 +5V  
 X21 Print 7000E

J1A 0.1

J1B 0.3

J2A 0.2

J2B 0.4

J3A 0.5

J3B 0.6

GND 0.7

X20 7  
 (gl/gn)

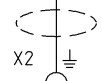

3.9 > GND

GND > 5.0

Analoge waarde Joystick  
 Analogwert Joystick  
 Analog value Joystick

This drawing is property of Holland Lift International. All rights reserved.  
 deze tekening is eigendom van Holland Lift International. Alle rechten voorbehouden.  
 deze tekening is eigendom van Holland Lift International. Alle rechten voorbehouden volgens de wet.



Holland Lift International B.V.  
 Anodeweg 1  
 NL-1627 LJ Hoorn The Netherlands  
 T/F +31 (0)229-285555 / 285550  
 E service@hollandlift.com  
 W www.hollandlift.com

STROOMKRINGSCHEMA  
 STROMLAUFPLAN  
 CIRCUIT DIAGRAM

Projekt:	EQ-21-001	Zeichnungsnummer:	Rev.:	erstellt von:
Datum:	01.09.2015	Anlage:	Ort:	Rothenbusch
		=	+	Blatt: 4

4.9 > +24V Battery  
 4.9 > +24V Emergency Stop

+24V Battery > 6.0  
 +24V Emergency Stop > 6.0

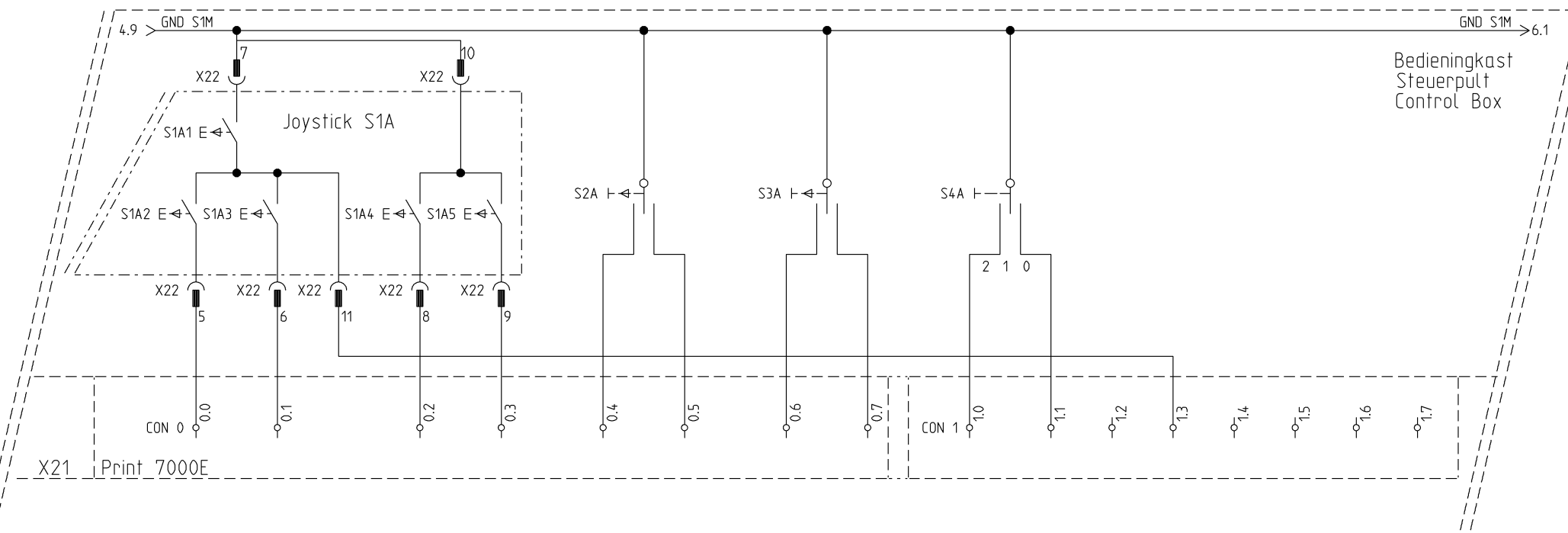

S4A

0 = Langzaam	Langsam	Slow
1 = Normal	Normal	Normal
2 = Snel	Schnell	Fast

4.9 > GND

GND > 6.0

- Op-Joysick-Neer
- Auf-Joystick-Nieder
- On-Joystick-Down
- Links-Sturen-Rechts
- Links-Lenken-Rechts
- Left-Steering-Right
- Claxon-Sign.gever
- Hupe-Signalgeber
- Horn-Signal
- Sper/Diff
- Sperr/Diff
- Slip/Diff
- Heffen
- Heben
- Lift Up
- Rijden
- Fahren
- Driving
- Snelheid
- Geschwindigkeit
- Speed
- S1A1 Dodemansknop
- S1A1 Totmansknopf
- S1A1 Dead Man's Button

this drawing is property of Holland Lift International, by all rights reserved  
 diese zeichnung ist eigentum von Holland Lift International, by urheberrecht vorbehalten nach dem gesetz  
 deze tekening is eigendom van Holland Lift International, by auteursrecht voorbehouden volgens de wet

5.9 > +24V Battery +24V Battery > 7.0  
 5.9 > +24V Emergency Stop +24V Emergency Stop > 7.0

Bedieningkast  
 Steuerpult  
 Control Box

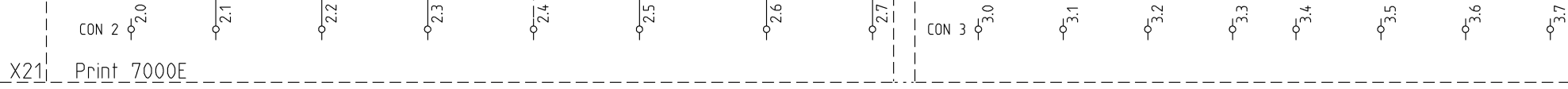
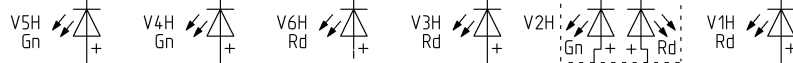

V2H  
 gn: Scheef. 1 & 2 OK    gl: Scheef. 2 net OK    rd: Scheef. 1 & 2 net OK  
 gn: Neigung 1 & 2 OK    gl: Neigung 2 nicht OK    rt: Neigung 1 & 2 nicht OK  
 gn: Tilt 1 & 2 OK    yl: Tilt 2 not OK    rd: Tilt 1 & 2 not OK

Scheefstand gn	Heffen	Rijden	Vetpomp	Overload	Scheefstand rd	Accu Leeg
Neigung gn	Heben	Fahren	Fett Pumpe	Ueberlastung	Neigung rt	Akku Leer
Grade/Slope gn	Lift Up	Driving	Grease Pump	Overload	Grade/Slope rd	Bat. Empty
			Optie/Option			

this drawing is property of Holland Lift International, by all rights reserved  
 deze tekening is eigendom van Holland Lift International, by all rights reserved  
 deze tekening is eigendom van Holland Lift International, by all rights reserved



Holland Lift International B.V.  
 Anodeweg 1  
 NL-1627 LJ Hoorn The Netherlands  
 T/F +31 (0)229-285555 / 285550  
 E service@hollandlift.com  
 W www.hollandlift.com

STROOMKRINGSCHEMA  
 STROMLAUFPLAN  
 CIRCUIT DIAGRAM

Projekt: EQ-21-001	Zeichnungsnummer:	Rev.:	erstellt von: Rothenbusch
Datum: 01.09.2015	Anlage: =	Ort: +	Blatt: 6

This drawing is property of Holland Lift International. All rights reserved.  
 deze tekening is eigendom van Holland Lift International. Alle rechten voorbehouden volgens de wet.  
 deze tekening is eigendom van Holland Lift International. Alle rechten voorbehouden volgens de wet.

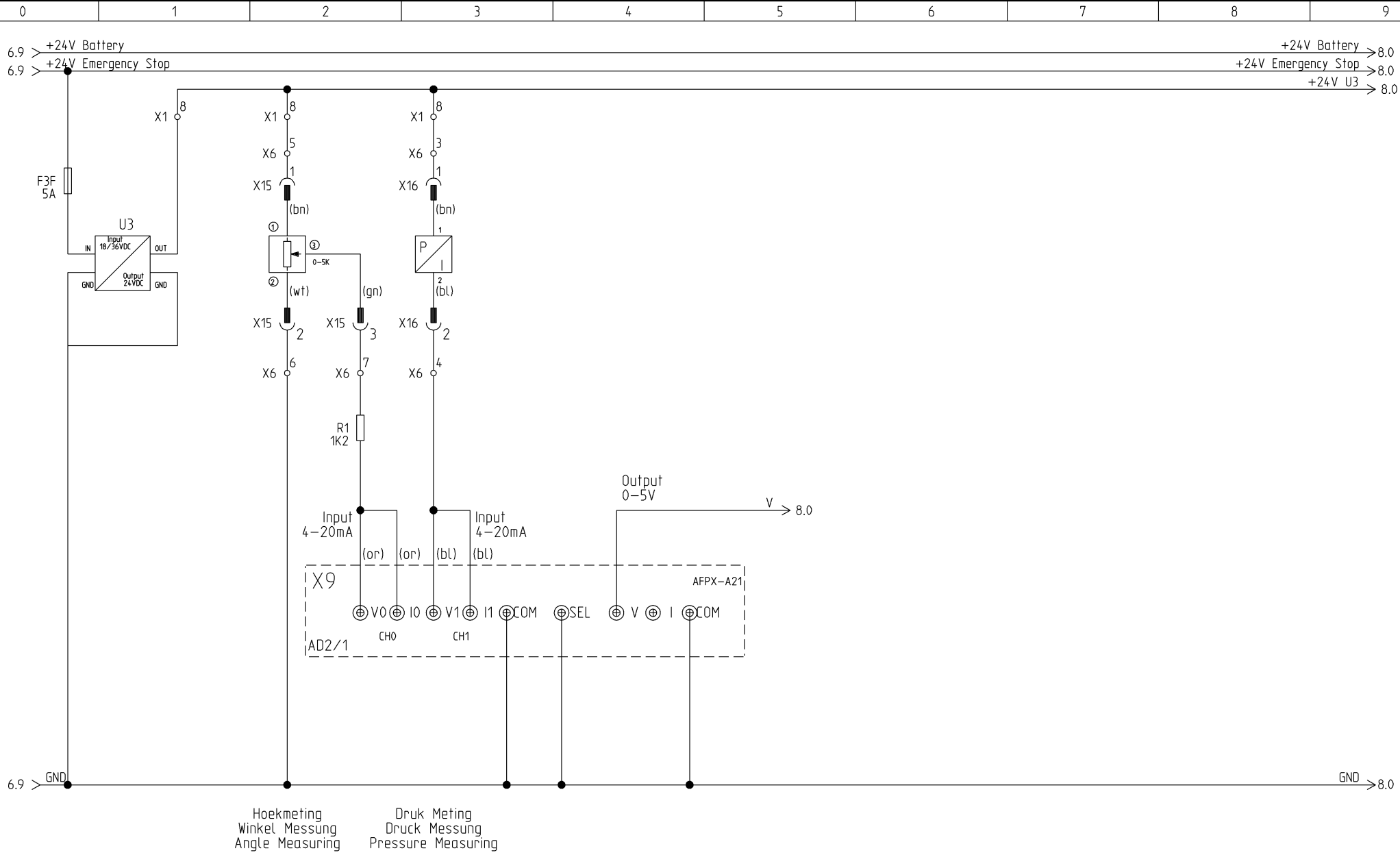

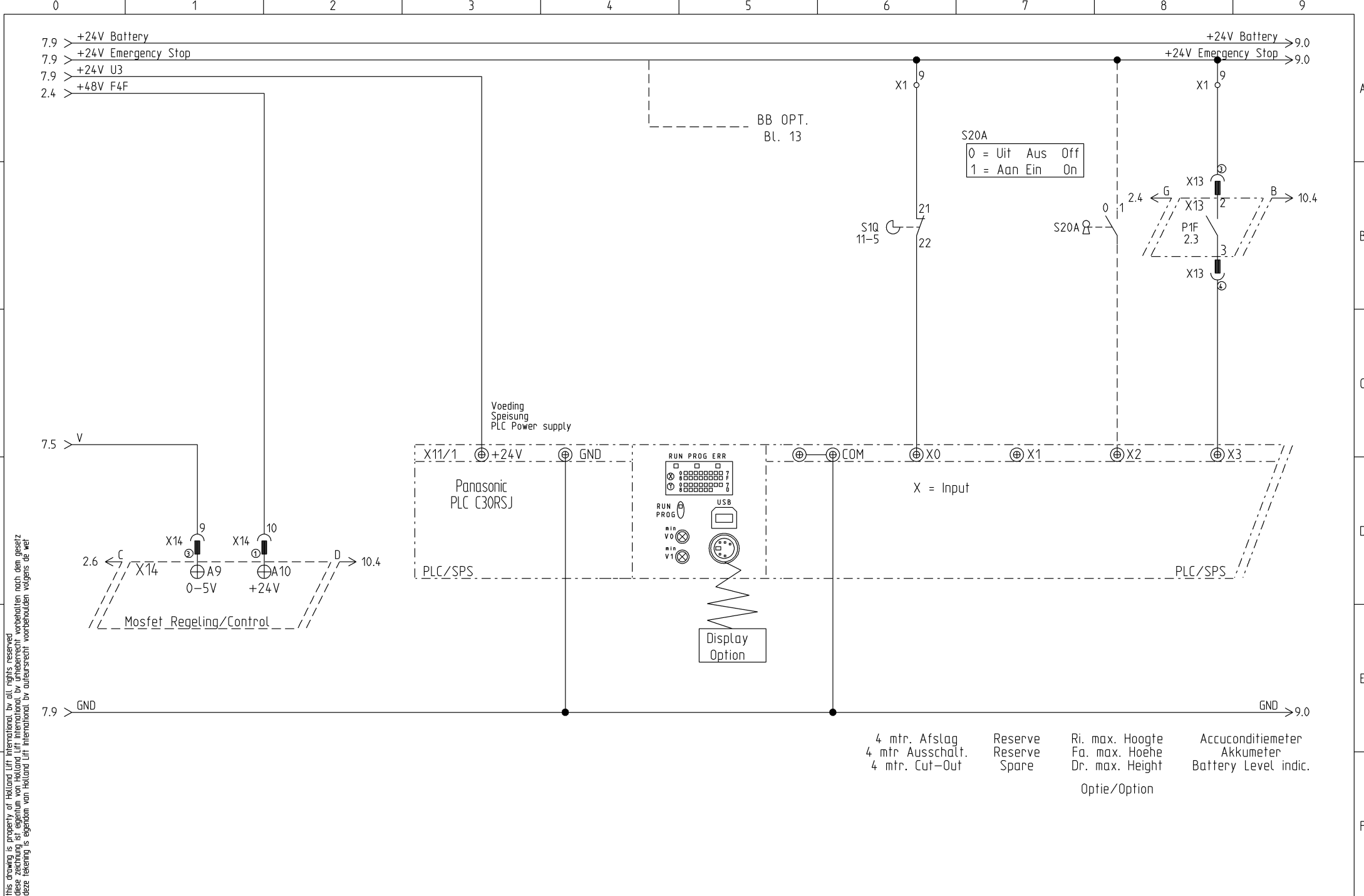

This drawing is property of Holland Lift International. All rights reserved.  
 diese Zeichnung ist Eigentum von Holland Lift International. Alle Rechte vorbehalten.  
 deze tekening is eigendom van Holland Lift International. Alle rechten voorbehouden volgens de wet



This drawing is property of Holland Lift International. All rights reserved.  
 deze tekening is eigendom van Holland Lift International. Alle rechten voorbehouden.  
 deze tekening is eigendom van Holland Lift International. Alle rechten voorbehouden volgens de wet.

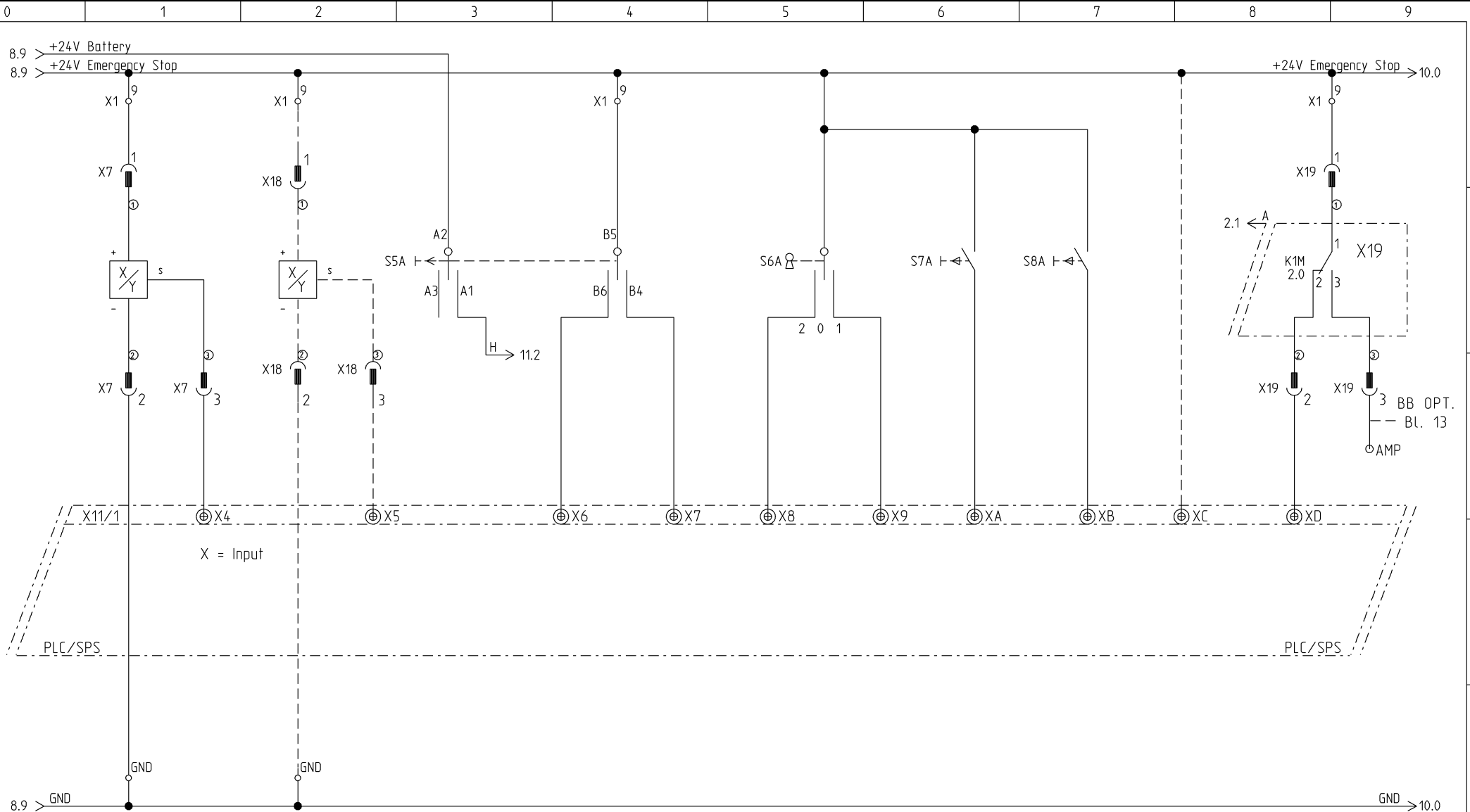

Scheefstand 1 Neigung 1 Grade/Slope 1	Scheefstand 2 Neigung 2 Grade/Slope 2 Optie/Option	Dalen Onderwagen Senken Chassis Lift Down Chassis	Heffen – Dalen Heben – Senken Lift Up – Lift Down	Progr. Uit Progr. Aus Progr. Off	Aan An An On	Store Store Store	Save Save Save	Overbr. Smeersyst. Ueberbr. Schmere Syst Jumper Grease Syst.	Acculader Akkuladegeraet Battery Charger
---	---	---	---	--	-----------------	-------------------------	----------------------	--	--

——— Overlast–Ueberlastung–Overload ———      Optie/Option



Holland Lift International B.V.  
 Anodeweg 1  
 NL-1627 LJ Hoorn The Netherlands  
 T/F +31 (0)229-285555 / 285550  
 E service@hollandlift.com  
 W www.hollandlift.com

STROOMKRINGSHEMA  
 STROMLAUFPLAN  
 CIRCUIT DIAGRAM

Projekt: EQ-21-001  
 Datum: 01.09.2015

Zeichnungsnummer:  
 Anlage: =

Rev.:  
 Ort: +

erstellt von:  
 Rothenbusch  
 Blatt: 9

This drawing is property of Holland Lift International. All rights reserved.  
 deze tekening is eigendom van Holland Lift International. Alle rechten voorbehouden.  
 deze tekening is eigendom van Holland Lift International. Alle rechten voorbehouden volgens de wet.

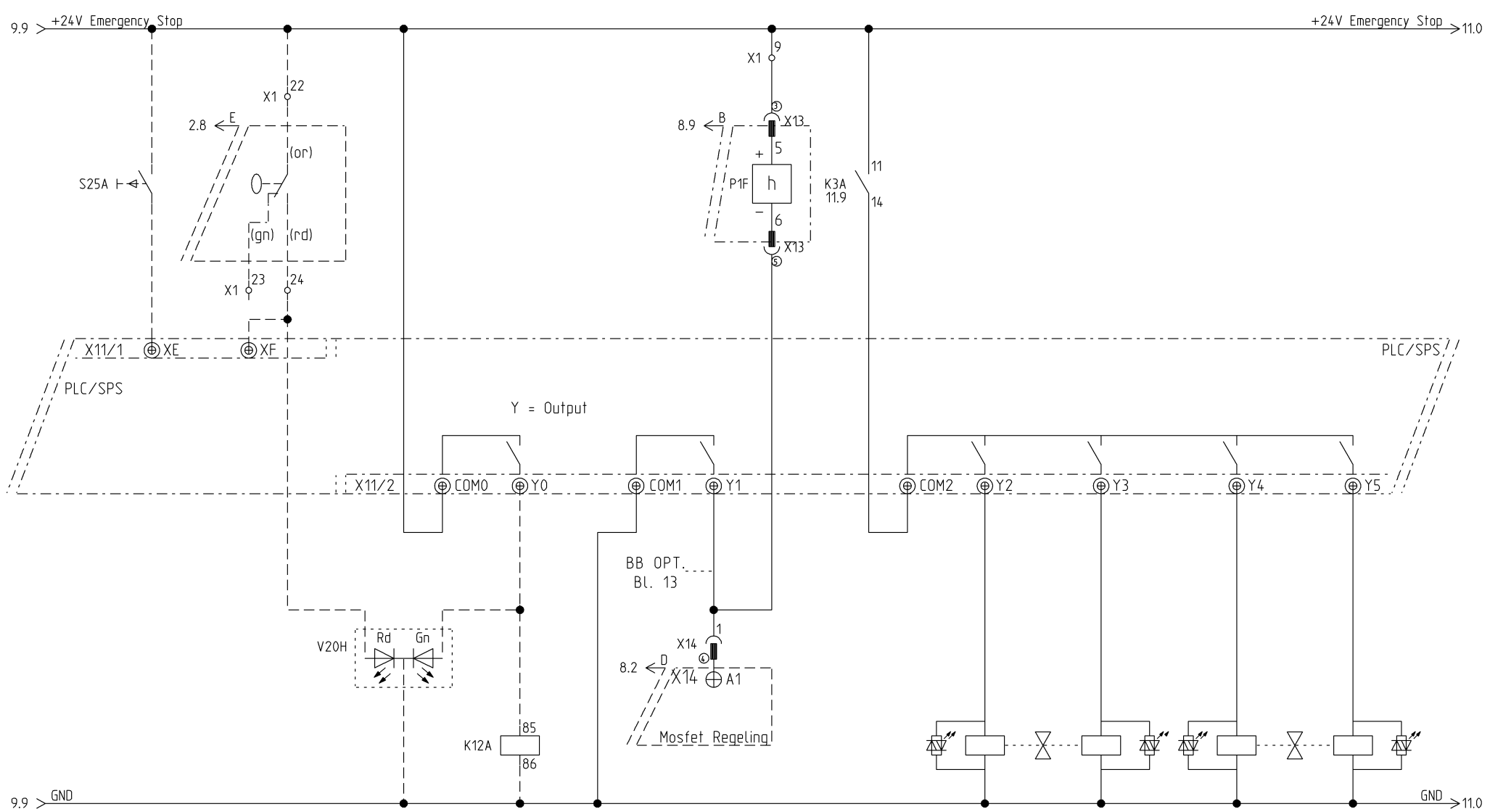

- Start Smeersyst.  
 Start Schmere Syst  
 Start Grease Syst.  
  
 Optie/Option
- Vlottier  
 Schwimmschalter  
 Fladt Switch  
  
 Optie/Option
- Leeg  
 Leer  
 Empty  
  
 Optie/Option
- In Bedrijf  
 In Betrieb  
 Run  
  
 Optie/Option
- Vetpomp  
 Fett Pumpe  
 Grease Pump  
  
 Optie/Option
- Urenteller  
 Stunde Zaehler  
 Hour Meter
- Links-Sturen-Rechts  
 Links-Lenken-Rechts  
 Left-Steering-Right
- Vooruit-Rijden-Achteruit  
 Vorw.-Fahren-Rueckw.  
 Forward-Driving-Reverse

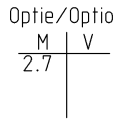

This drawing is property of Holland Lift International. By all rights reserved.  
 deze tekening is eigendom van Holland Lift International. By auteursrecht voorbehouden volgens de wet.  
 deze tekening is eigendom van Holland Lift International. By auteursrecht voorbehouden volgens de wet.

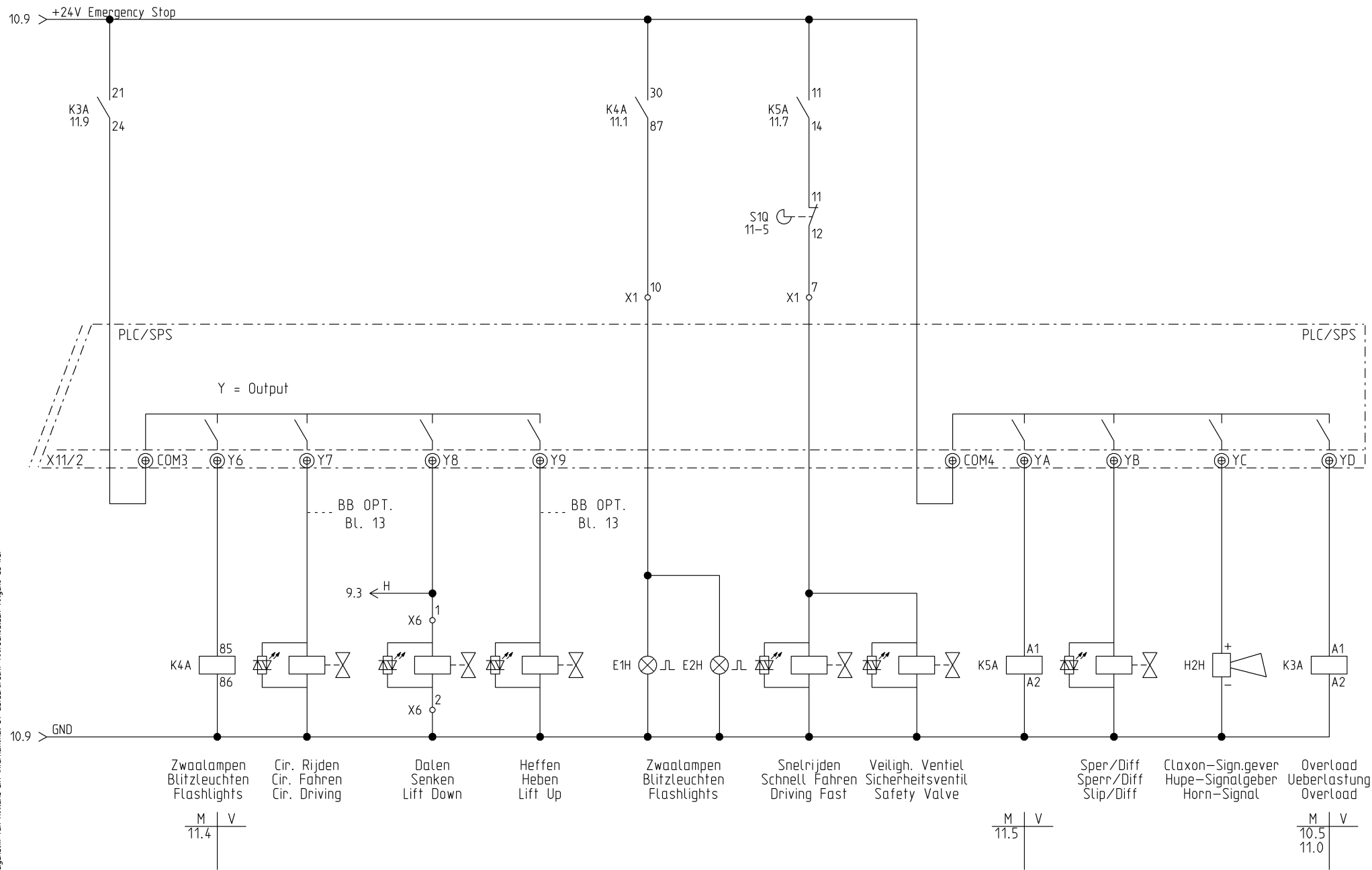

- Zwaalampen  
Blitzleuchten  
Flashlights
- Cir. Rijden  
Cir. Fahren  
Cir. Driving
- Dalen  
Senken  
Lift Down
- Heffen  
Heben  
Lift Up
- Zwaalampen  
Blitzleuchten  
Flashlights
- Snelrijden  
Schnell Fahren  
Driving Fast
- Veiligh. Ventiel  
Sicherheitsventil  
Safety Valve
- Sper/Diff  
Sperr/Diff  
Slip/Diff
- Claxon-Sign.gever  
Hupe-Signalgeber  
Horn-Signal
- OverLoad  
Ueberlastung  
Overload

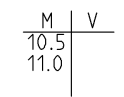
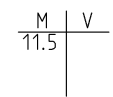

Holland Lift International B.V.  
 Anodeweg 1  
 NL-1627 LJ Hoorn The Netherlands  
 T/F +31 (0)229-285555 / 285550  
 E service@hollandlift.com  
 W www.hollandlift.com

STROOMKRINGSCHEMA  
 STROMLAUFPLAN  
 CIRCUIT DIAGRAM

Projekt: EQ-21-001  
 Datum: 01.09.2015

Zeichnungsnummer:  
 Anlage: =

Rev.:  
 Ort: +

erstellt von:  
 Rothenbusch  
 Blatt: 11

OPTIES  
OPTIONEN  
OPTIONS

230V AANSLUITING PLATFORM  
230V ANSCHLUSS PLATTFORM  
230V SUPPLY PLATFORM

<230VPLF>

230V-50Hz/115V-50Hz

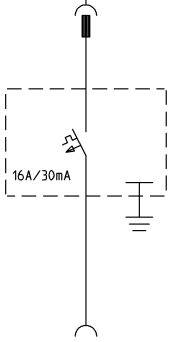

AARDLEKAUTOMAAT  
FI SCHALTER  
EARTH DETECTOR

This drawing is property of Holland Lift International, by all rights reserved.  
 diese Zeichnung ist Eigentum von Holland Lift International, by urheberrecht vorbehalten nach dem gesetz  
 deze tekening is eigendom van Holland Lift International, by auteursrecht voorbehouden volgens de wet



Holland Lift International B.V.  
Anodeweg 1  
NL-1627 LJ Hoorn The Netherlands  
T/F +31 (0)229-285555 / 285550  
E service@hollandlift.com  
W www.hollandlift.com

OPTIES  
OPTIONEN  
OPTIONS

Projekt: EQ-21-001	Zeichnungsnummer:	Rev.:	erstellt von: Rothenbusch
Datum: 01.09.2015	Anlage: =	Ort: +	Blatt: 12

# OPTIES OPTIONEN OPTIONS

**BELANGRIJK/WICHTIG/IMPORTANT**

BIJ TOEPASSING BLACK-BOX  
BEI BLACK-BOX  
WHEN BLACK-BOX IS USED

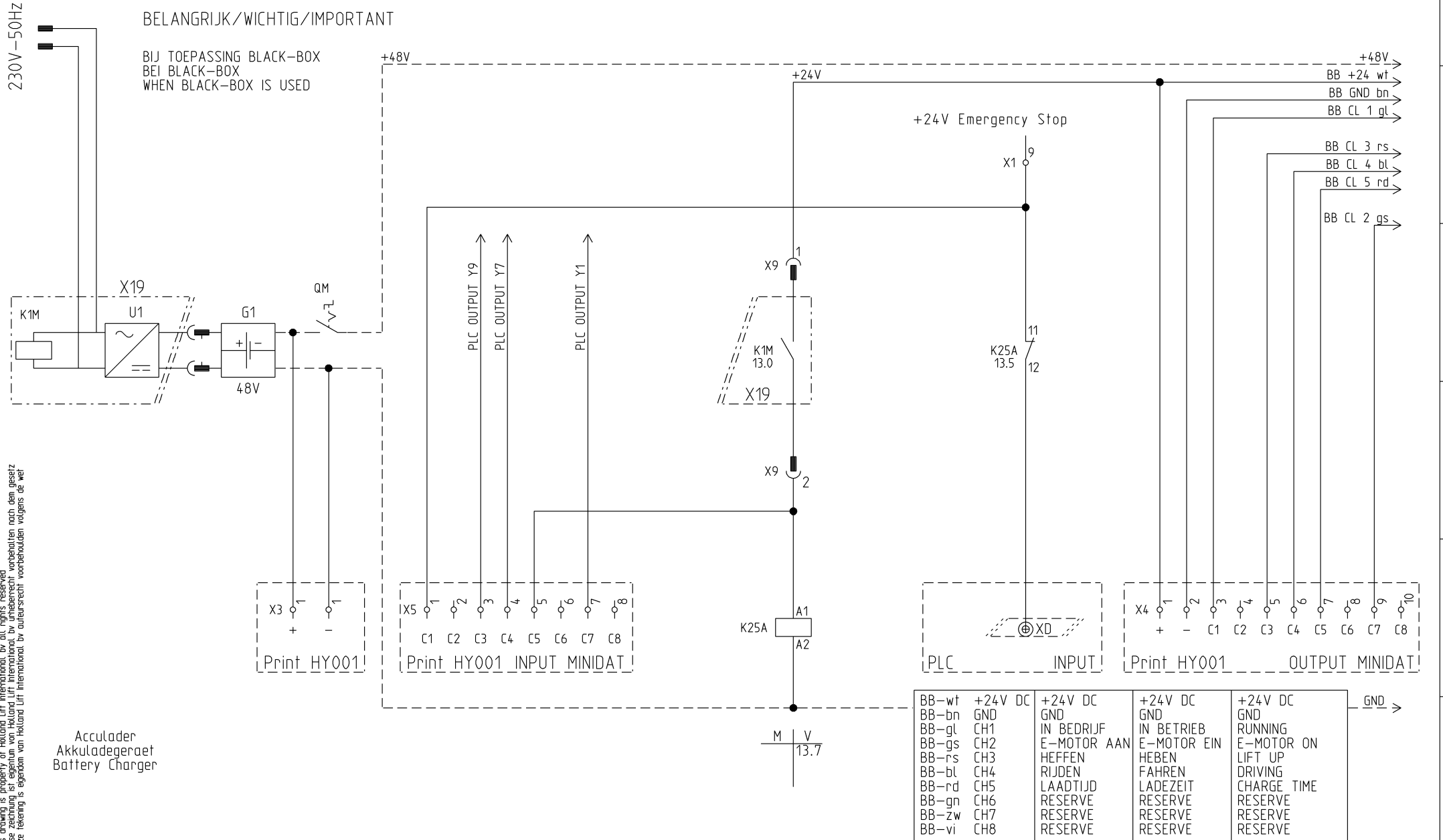

This drawing is property of Holland Lift International. All rights reserved.  
 diese Zeichnung ist Eigentum von Holland Lift International. Alle Rechte vorbehalten.  
 deze tekening is eigendom van Holland Lift International. Alle rechten voorbehouden volgens de wet

Acculader  
Akkuladegeraet  
Battery Charger

BB-wt	+24V DC	+24V DC	+24V DC	+24V DC	GND
BB-bn	GND	GND	GND	GND	GND
BB-gl	CH1	IN BEDRIJF	IN BETRIEB	RUNNING	
BB-gs	CH2	E-MOTOR AAN	E-MOTOR EIN	E-MOTOR ON	
BB-rs	CH3	HEFFEN	HEBEN	LIFT UP	
BB-bl	CH4	RIJDEN	FAHREN	DRIVING	
BB-rd	CH5	LAADTIJD	LADEZEIT	CHARGE TIME	
BB-gn	CH6	RESERVE	RESERVE	RESERVE	
BB-zw	CH7	RESERVE	RESERVE	RESERVE	
BB-vi	CH8	RESERVE	RESERVE	RESERVE	

# KLEMMENKAST KLEMMENKASTEN CONNECTION BOX

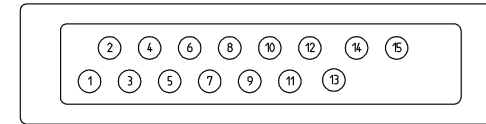
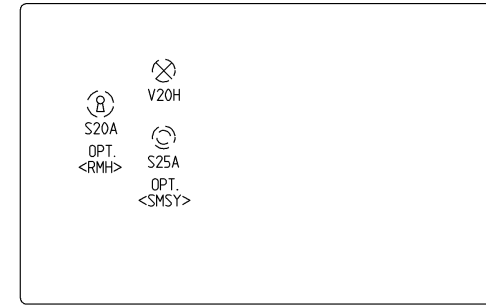
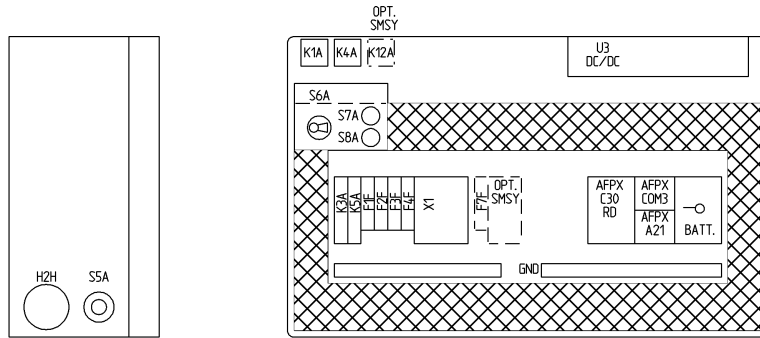

WARTEL KABELEINF. GLAND NR.	KLEM KLEMMEN TERMINAL NR	FUNKTIE	FUNKTION	FUNCTION
1	DIV/VAR	Aansl. 6P Platform	Anschl. 6P Plattform	Conn. 6P Platform
2.1	DIV/VAR	4mtr. Afslag S1Q	4mtr. Ausschaltung S1Q	4mtr. Cut-out S1Q
2.2	DIV/VAR	Black-Box Option	Black-Box Option	Black-Box Option
3	DIV/VAR	Lasdoos X6	Verteilerdose X6	Connection Box X6
4.1	Y2-GND	Sturen Links	Lenken Links	Steering Left
4.2	Y3-GND	Sturen Rechts	Lenken Rechts	Steering Right
5.1	Y9-GND	Heffen	Heben	Lift Up
5.2	Y7-GND	Cir. Ventiel Rijden	Cir. Ventil Fahren	Cir. Valve Diving
6.1	Y4-GND	Rijden Vooruit	Fahren Vorwaerts	Driving Forward
6.2	Y5-GND	Rijden Achteruit	Fahren Rueckwaerts	Driving Reverse
7.1	YA-GND	Veiligheids Ventiel	Sicherheitsventil	Safety Valve
7.2	φ7-GND	Snelrijden	Schnell Fahren	Driving Fast
8.1	YB-GND	Sper/Diff. Ventiel	Sperr/Diff. Ventil	Slip/Diff. Valve
8.2	DIV/VAR	Mosfet Motorreq	Mosfet Motorreq	Mosfet Motor Con
9.1	DIV/VAR	Accumeter	Akkumeter	Batterymeter
9.2	DIV/VAR	Acculader	Akkuladegeraet	Battery Charger
10.1	F1F-GND	Accu +/- 24VDC	Akku +/- 24VDC	Battery +/- 24VDC
10.2	F4F-GND	Accu +/- 48VDC	Akku +/- 48VDC	Battery +/- 48VDC
11.1	φ9-GND-X4	Scheefstand 1	Neigung 1	Inclination 1
11.2	φ9-GND-X5	Scheefstand 2 Opt.	Neigung 2 Opt.	Inclination 2 Opt.
12.1	φ10-GND	Zwaailamp	Blitzleuchte	Flashlight
12.2	φ10-GND	Zwaailamp	Blitzleuchte	Flashlight
13	φ9-GND	Ventilator Koeling	Fan Kuehlung	Cooling Fan
14	DIV/VAR	Smeersytem Opt.	Schmiere System Opt.	Grease System Opt.

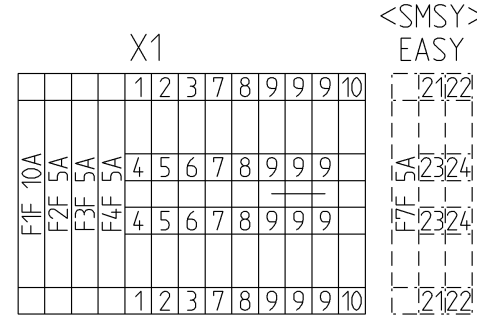

AANSLUITING OP PLATFORM  
ANSCHLUSS AUF PLATTFORM  
CONNECTION ON PLATFORM

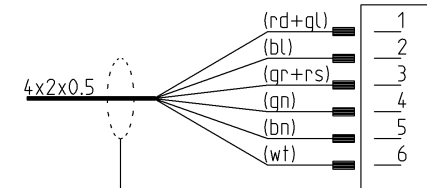

Afscherming  
niet aansluiten  
(aftapen)

This drawing is property of Holland Lift International. All rights reserved.  
 diese Zeichnung ist Eigentum von Holland Lift International. Alle Rechte vorbehalten.  
 deze tekening is eigendom van Holland Lift International. Alle auteursrechten voorbehouden volgens de wet.

LASDOOS AFSLAGEN (X6)  
 VERTEILERDOSE HOEHEAUSSCHALTUNG (X6)  
 MAXIMUM HEIGHT DISTRBUOR BOX (X6)

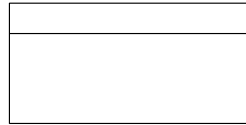
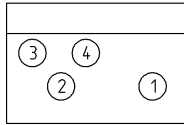
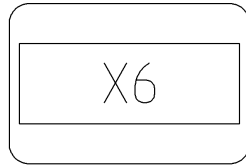

2-4 M12  
 1 M20

WARTEL KABELINF. GLAND NR. (X6)	Omschrijving	Beschreibung	Description
1	Kabel Klemmenkast	Kabel Klemmenkasten	Cable Connection Box
2	Dalen	Senken	Lift Down
3	Druk Meting	Druck Messung	Pressure Measuring
4	Hoekmeting	Winkel Messung	Angle Measuring

KABEL KLEMMENKAST KABEL KLEMMENKASTEN CABLE CONNECITON BOX (18x1)	KLEM KLEMME TERMINAL NR. (KLEMMENKAST)	KLEM KLEMME TERMINAL NR. (X6)	Omschrijving	Beschreibung	Description
1	Y8	1	Dalen	Senken	Lift Down
2	GND	2	Dalen	Senken	Lift Down
3	φ 8	3	Druk Meting	Druck Messung	Pressure Measuring
4	V1 AMP	4	Druk Meting	Druck Messung	Pressure Measuring
5	φ 8	5	Hoekmeting	Winkel Messung	Angle Measuring
6	GND	6	Hoekmeting	Winkel Messung	Angle Measuring
7	V0 AMP	7	Hoekmeting	Winkel Messung	Angle Measuring
8	Res./Spare	8	Reserve	Reserve	Spare
9	Res./Spare	9	Reserve	Reserve	Spare
10	Res./Spare	10	Reserve	Reserve	Spare
11	Res./Spare	11	Reserve	Reserve	Spare
12	Res./Spare	12	Reserve	Reserve	Spare
13-18	Res./Spare		Reserve	Reserve	Spare

This drawing is property of Holland Lift International, by all rights reserved.  
 diese Zeichnung ist Eigentum von Holland Lift International, by urheberrecht vorbehalten nach dem gesetz  
 deze tekening is eigendom van Holland Lift International, by auteursrecht voorbehouden volgens de wet

BEDIENINGSKAST  
STEUERPULT  
CONTROL BOX

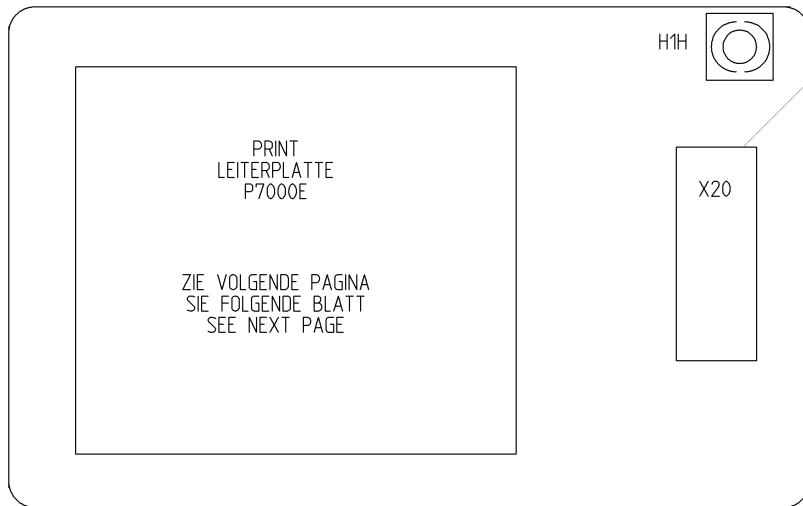
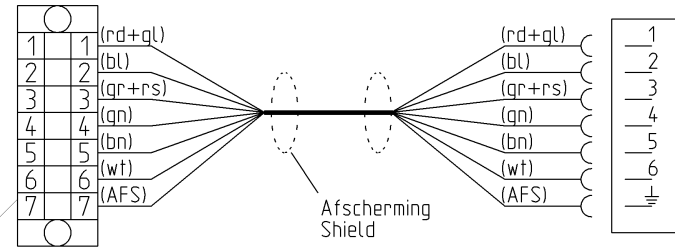
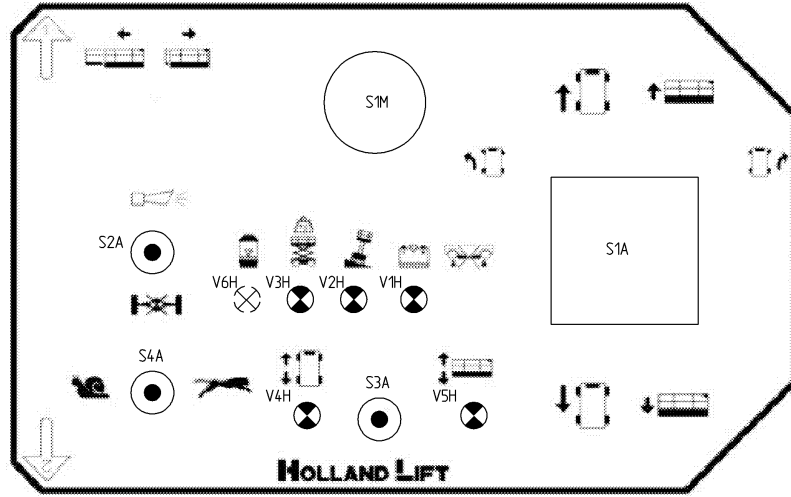

Colour schedule			
Colour	Dutch	English	Deutsch
Rd	Rood	Red	Rot
Bl	Blauw	Blue	Blau
Gl	Geel	Yellow	Gelb
Gn	Groen	Green	Gruen
Zw	Zwart	Black	Schwarz
Wt	Wit	White	Weiss
Bn	Bruin	Brown	Braun
Rs	Roze	Pink	Rosa
Or	Oranje	Orange	Orange
Ps	Paars	Violet	Violett
Tp	Transp.	Transp.	Transp.
Gs	Grijs	Grey	Grau

This drawing is property of Holland Lift International, by all rights reserved.  
 diese Zeichnung ist Eigentum von Holland Lift International, by urheberrecht vorbehalten nach dem gesetz  
 deze tekening is eigendom van Holland Lift International, by auteursrecht voorbehouden volgens de wet



PRINTPLAAT  
LEITERPLATTE  
CIRCUIT BOARD

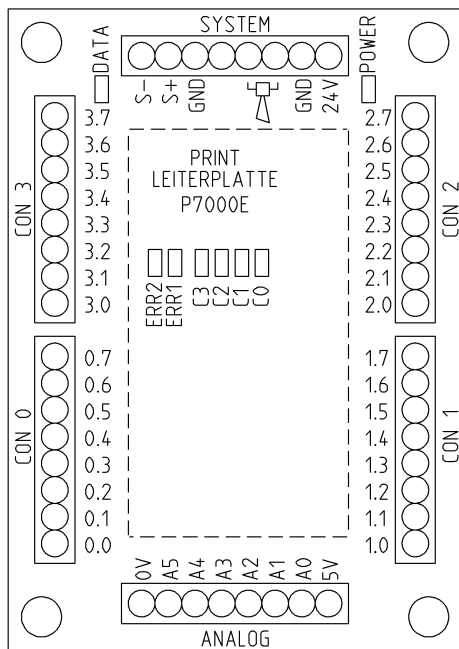

Power	<input type="checkbox"/> Groen/Gruen/Green	Voeding Ok	Speisung Ok	Supply Ok
Data	<input type="checkbox"/> Geel/Gelb/Yellow	Data Ok	Data Ok	Data Ok
Err1	<input type="checkbox"/> Rood/Rot/Red	Slechte Data Verbinding	Schlechte Data Verbindung	Poor Data Connection
Err2	<input type="checkbox"/> Rood/Rot/Red	Geen Data Verbinding	Keine Data Verbindung	No Data Connection
C3	<input type="checkbox"/> Geel/Gelb/Yellow	Input CON 3	Eingang CON 3	Input CON 3
C2	<input type="checkbox"/> Geel/Gelb/Yellow	Input CON 2	Eingang CON 2	Input CON 2
C1	<input type="checkbox"/> Geel/Gelb/Yellow	Input CON 1	Eingang CON 1	Input CON 1
C0	<input type="checkbox"/> Geel/Gelb/Yellow	Input CON 0	Eingang CON 0	Input CON 0

CON A 0V	GND Joystick	GND Joystick	GND Joystick
CON A A5	Reserve	Reserve	Spare
CON A A4	Reserve	Reserve	Spare
CON A A3	Reserve	Reserve	Spare
CON A A2	Reserve	Reserve	Spare
CON A A1	Reserve	Reserve	Spare
CON A A0	0,5-4,5V Joystick P1	0,5-4,5V Joystick P1	0,5-4,5V Joystick P1
CON A 5V	Voeding +5V Joystick	Speisung +5V Joystick	Supply +5V Joystick

CON 1 1.0	Snel Rijden (S4A1)	Schnell Fahren (S4A1)	Driving Fast (S3A1)
CON 1 1.1	Langzaam Rij. (S4A2)	Langsam Fahren (S4A2)	Driving Slow (S4A1)
CON 1 1.2	Reserve	Reserve	Spare
CON 1 1.3	Dodemansknop (S1A1)	Totmansknopf (S1A1)	Dead Man (S1A1)
CON 1 1.4	Reserve	Reserve	Spare
CON 1 1.5	Reserve	Reserve	Spare
CON 1 1.6	Reserve	Reserve	Spare
CON 1 1.7	Reserve	Reserve	Spare

CON 2 2.0	Reserve	Reserve	Spare
CON 2 2.1	Scheefstand gn (V2H)	Neigung gn (V2H)	Inclination (V2H)
CON 2 2.2	Lift Mode (V5H)	Lift Mode (V5H)	Lift Mode gn (V5H)
CON 2 2.3	Drive Mode (V4H)	Drive Mode (V4H)	Drive Mode (V4H)
CON 2 2.4	Vetpomp (V6H) Opt.	Fett Pumpe (V6H) Opt.	Grease Pump (V6H) Opt.
CON 2 2.5	Overload (V3H)	Ueberlastung (V3H)	Overload (V3H)
CON 2 2.6	Scheefstand rd (V2H)	Neigung rd (V2H)	Inclination rd (V2H)
CON 2 2.7	Accu leeg (V1H)	Akku leer (V1H)	Battery empty (V1H)

CON SYS 0.0	Voeding +24V (S1M)	Speisung +24V (S1M)	Supply +24V (S1M)
CON SYS 0.1	GND	GND	GND
CON SYS 0.2	+ Zoemer H1H	+ Summer H1H	+ Buzzer H1H
CON SYS 0.3	- Zoemer H1H	- Summer H1H	- Buzzer H1H
CON SYS 0.4	Reserve	Reserve	Spare
CON SYS 0.5	Reserve	Reserve	Spare
CON SYS 0.6	Data S+ (RS485)	Data S+ (RS485)	Data S+ (RS485)
CON SYS 0.7	Data S- (RS485)	Data S- (RS485)	Data S- (RS485)

CON 3 3.0	Reserve	Reserve	Spare
CON 3 3.1	Reserve	Reserve	Spare
CON 3 3.2	Reserve	Reserve	Spare
CON 3 3.3	Reserve	Reserve	Spare
CON 3 3.4	Reserve	Reserve	Spare
CON 3 3.5	Reserve	Reserve	Spare
CON 3 3.6	Reserve	Reserve	Spare
CON 3 3.7	Reserve	Reserve	Spare

CON 0 0.0	Joysick Op (S1A2)	Fahren Joy. Auf (S1A2)	Joysick On (S1A2)
CON 0 0.1	Joysick Neer (S1A3)	Fahren Joy. Nied. (S1A3)	Joysick Down (S1A3)
CON 0 0.2	Sturen Links (S1A4)	Lenken Links (S1A4)	Steering Left (S1A4)
CON 0 0.3	Sturen Rechts (S1A5)	Lenken Rechts (S1A5)	Steering Right (S1A5)
CON 0 0.4	Claxon (S2A1)	Hupe (S2A1)	Horn (S2A1)
CON 0 0.5	Sper/Diff. (S2A2)	Sperr/Diff. (S2A2)	Slip/Diff. (S2A2)
CON 0 0.6	Heffen (S3A1)	Heben (S3A1)	Lift up (S3A1)
CON 0 0.7	Rijden (S3A2)	Fahren (S3A2)	Driving (S3A2)

This drawing is property of Holland Lift International, by all rights reserved.  
 deze tekening is eigendom van Holland Lift International, by all rights reserved.  
 deze tekening is eigendom van Holland Lift International, by all rights reserved.



Holland Lift International B.V.  
 Anodeweg 1  
 NL-1627 LJ Hoorn The Netherlands  
 T/F +31 (0)229-285555 / 285550  
 E service@hollandlift.com  
 W www.hollandlift.com

PRINTPLAAT  
LEITERPLATTE  
CIRCUIT BOARD

Projekt:	EQ-21-001	Zeichnungsnummer:	Rev.:	erstelt von:
Datum:	01.09.2015	Anlage:	Ort:	Rothenbusch
				Blatt: 17