

this drawing is property of Holland Lift International, by all rights reserved.
 deze tekening is eigendom van Holland Lift International, by all rights reserved.
 deze tekening is eigendom van Holland Lift International, by all rights reserved.

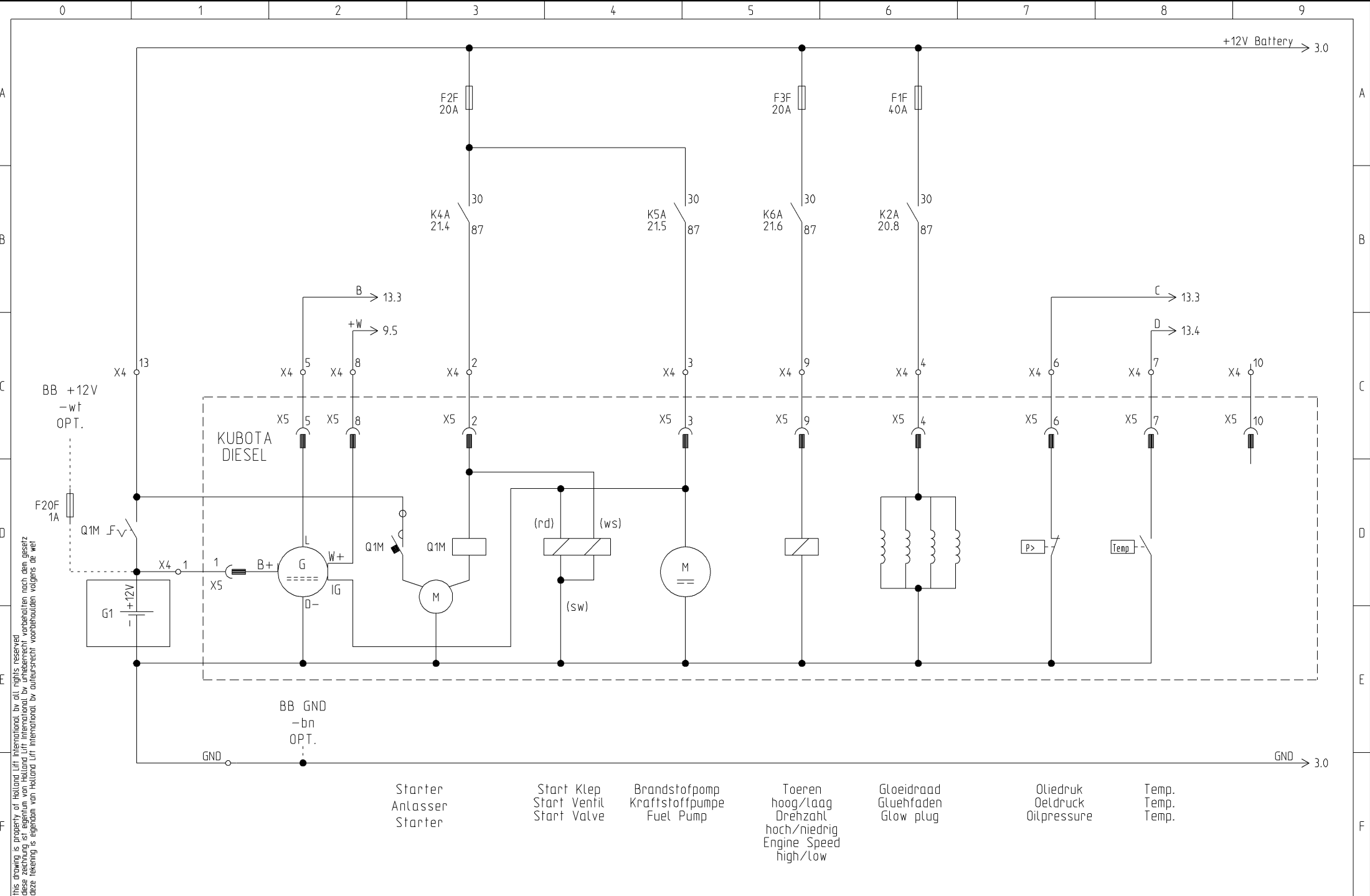

Starter
Anlasser
Starter

Start Klep
Start Ventil
Start Valve

Brandstoffpomp
Kraftstoffpumpe
Fuel Pump

Toeren
hoog/Laag
Drehzahl
hoch/niedrig
Engine Speed
high/Low

Gløidraad
Gløehfaden
Glow plug

Oløiedruk
Oilpressure

Temp.
Temp.
Temp.



Holland Lift International B.V.
Anodeweg 1
NL-1627 LJ Hoorn The Netherlands
T/F +31 (0)229-285555 / 285550
E service@hollandlift.com
W www.hollandlift.com

STROOMKRINGSCHEMA
STROMLAUFPLAN
CIRCUIT DIAGRAM

Projekt:
EQ-23-001
Datum:
31.05.2017

Zeichnungsnummer:
Anlage:
=

Rev.:
A
Ort:
+

erstellt von:
Rothenbusch
Blatt:
2

this drawing is property of Holland Lift International, by all rights reserved
 deze tekening is eigendom van Holland Lift International, by alle rechten voorbehouden
 diese Zeichnung ist Eigentum von Holland Lift International, by alle Rechte vorbehalten
 deze tekening is eigendom van Holland Lift International, by auteursrecht voorbehouden volgens de wet

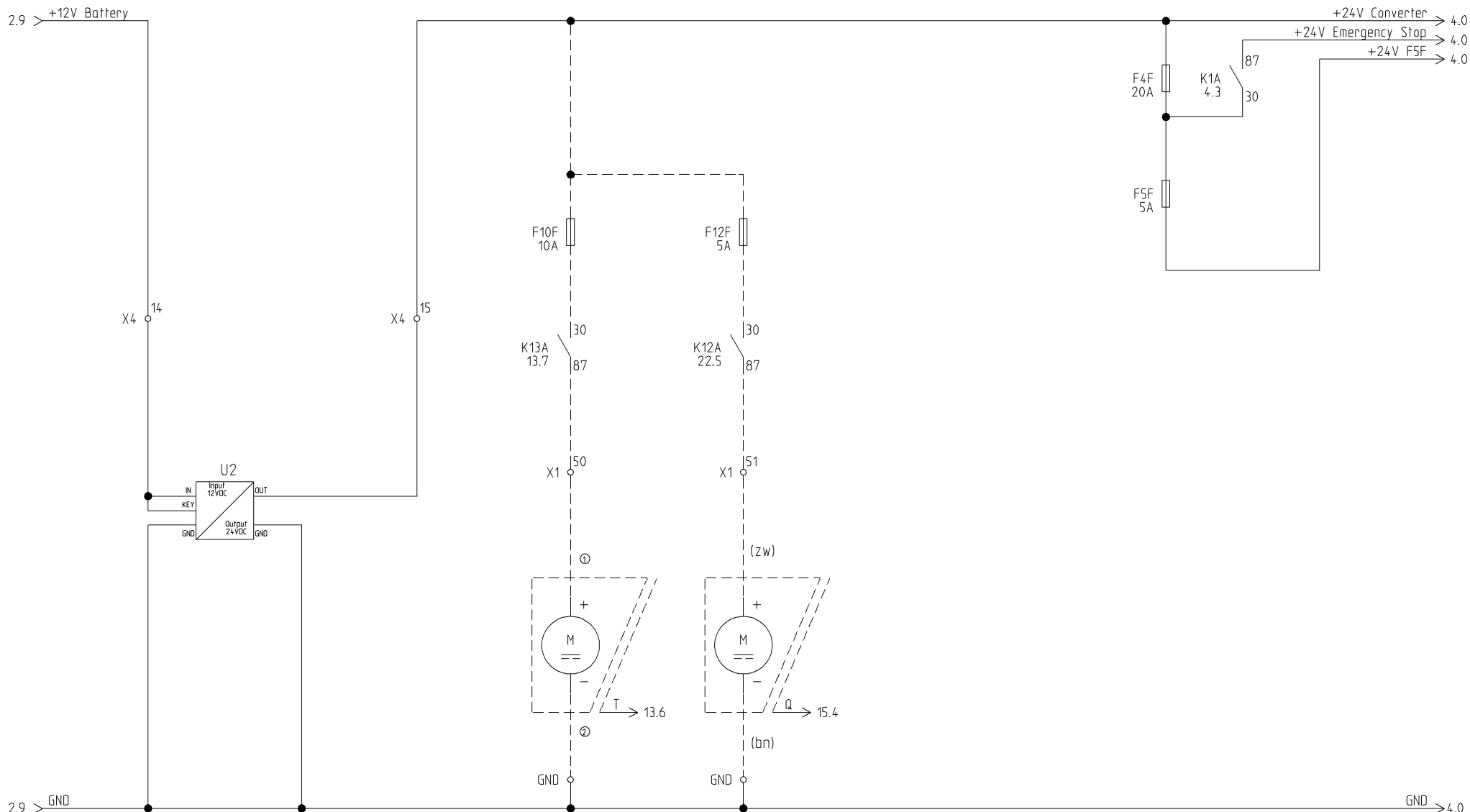

Koeler Hd. Olie
 Kuehler Hd. Oel
 Cooler Hd. Oil
 Optie/Option

Verpomp Easy Lube
 Fett Pumpe Easy Lube
 Grease Pump Easy Lube
 Optie/Option



Holland Lift International B.V.
 Anodeweg 1
 NL-1627 LJ Hoorn The Netherlands
 T/F +31 (0)229-285555 / 285550
 E service@hollandlift.com
 W www.hollandlift.com

STROOMKRINGSCHEMA
 STROMLAUFPLAN
 CIRCUIT DIAGRAM

Projekt:	EQ-23-001	Zeichnungsnummer:	Rev.:	A	erstellt von:	Rothenbusch	
Datum:	31.05.2017	Anlage:	=	Ort:	+	Blatt:	3

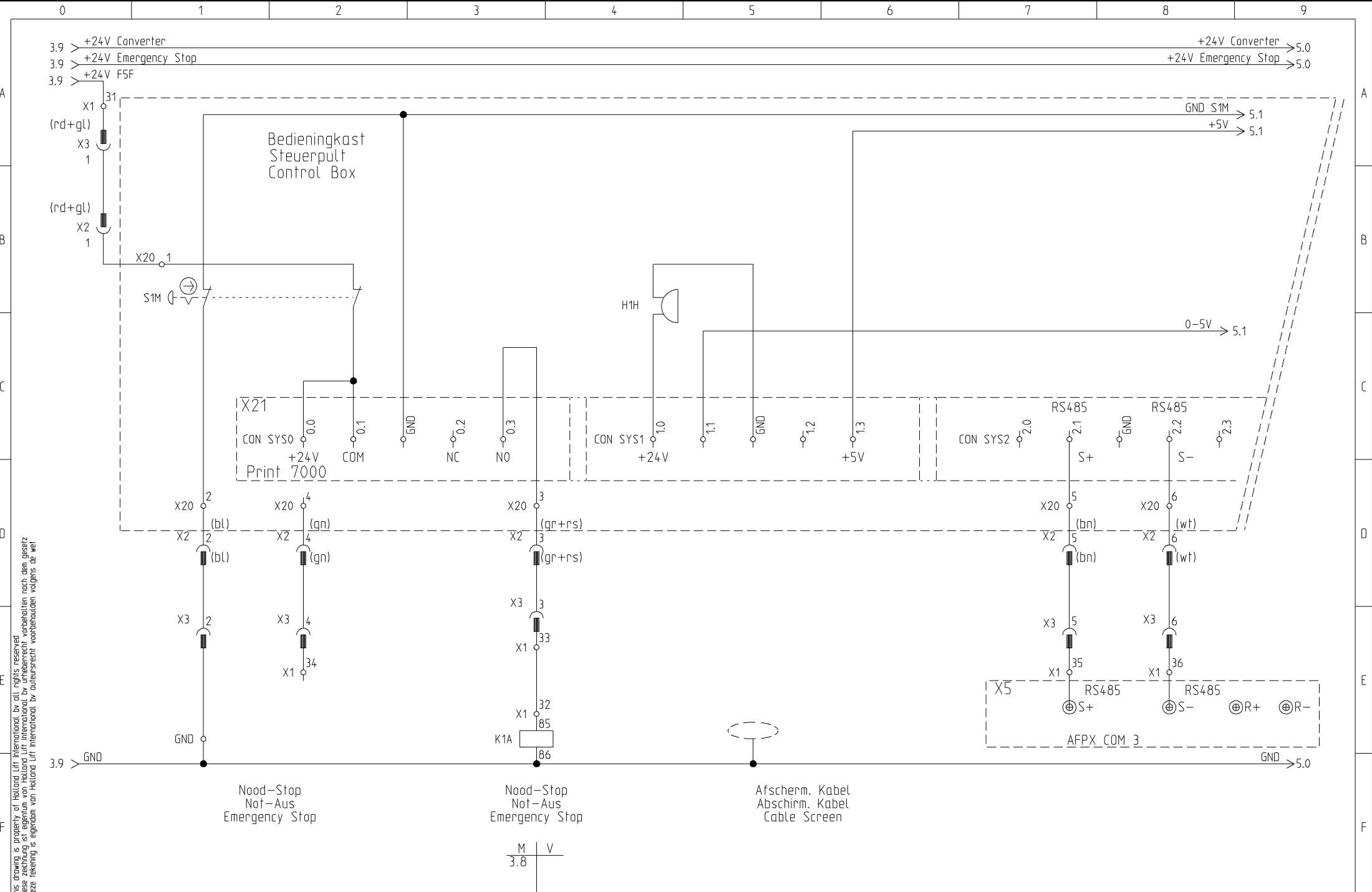

this drawing is property of Holland Lift International, by all rights reserved
 deze tekening is eigendom van Holland Lift International, by all rights reserved
 deze tekening is eigendom van Holland Lift International, by all rights reserved



Holland Lift International B.V.
 Anodeweg 1
 NL-1627 LJ Hoorn The Netherlands
 T/F +31 (0)229-285555 / 285550
 E service@hollandlift.com
 W www.hollandlift.com

STROOMKRINGSHEMA
 STROMLAUFPLAN
 CIRCUIT DIAGRAM

Projekt: EQ-23-001
 Datum: 31.05.2017

Zeichnungsnummer:
 Anlage: =

Rev.: A
 Ort: +

erstellt von: Rothenbusch
 Blatt: 4

M | V
 3.8

4.9 > +24V Converter
4.9 > +24V Emergency Stop

+24V Converter > 6.0
+24V Emergency Stop > 6.0

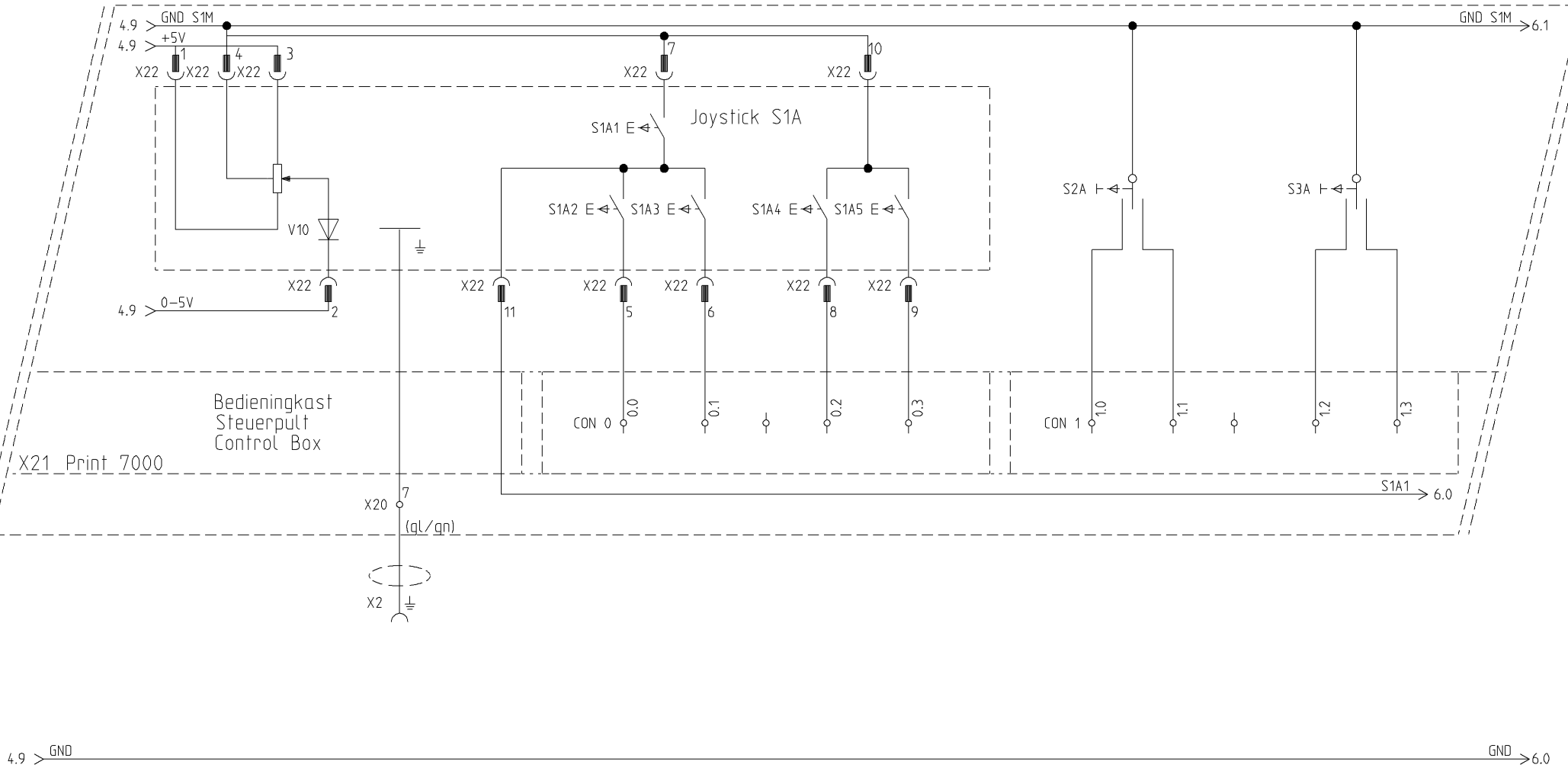

Bedieningkast
Steuerpult
Control Box

X21 Print 7000

X20 7
(qL/qn)

S1A1 > 6.0

4.9 > GND

GND > 6.0

S1A1 Dodemansknop
S1A1 Totmansknop
S1A1 Dead Man,s Button

Op-Joysick-Neer
Auf-Joystick-Nieder
On-Joystick-Down

Links-Sturen-Rechts
Links-Lenken-Rechts
Left-Steering-Right

Claxon-Sign.gever
Hupe-Signalgeber
Horn-Signal

Sper/Diff
Sperr/Diff
Stip/Diff

Heffen/Dalen
Heben/Senken
Lift Up/Lift Down

Rijden/Sturen
Fahren/Lenken
Driving/Steering

Mode

this drawing is property of Holland Lift International, by all rights reserved
diese zeichnung ist eigentum von Holland Lift International, by all rights reserved
deze tekening is eigendom van Holland Lift International, by auteursrecht voorbehouden volgens de wet

HOLLAND LIFT

Holland Lift International B.V.
Anodeweg 1
NL-1627 LJ Hoorn The Netherlands
T/F +31 (0)229-285555 / 285550
E service@hollandlift.com
W www.hollandlift.com

STROOMKRINGSHEMA
STROMLAUFPLAN
CIRCUIT DIAGRAM

Projekt:
EQ-23-001

Zeichnungsnummer:

Rev.: A

erstellt von:
Rothenbusch

Datum:
31.05.2017

Anlage:
=

Ort:
+

Blatt:
5

5.9 > +24V Converter
 5.9 > +24V Emergency Stop

+24V Converter > 7.0
 +24V Emergency Stop > 7.0

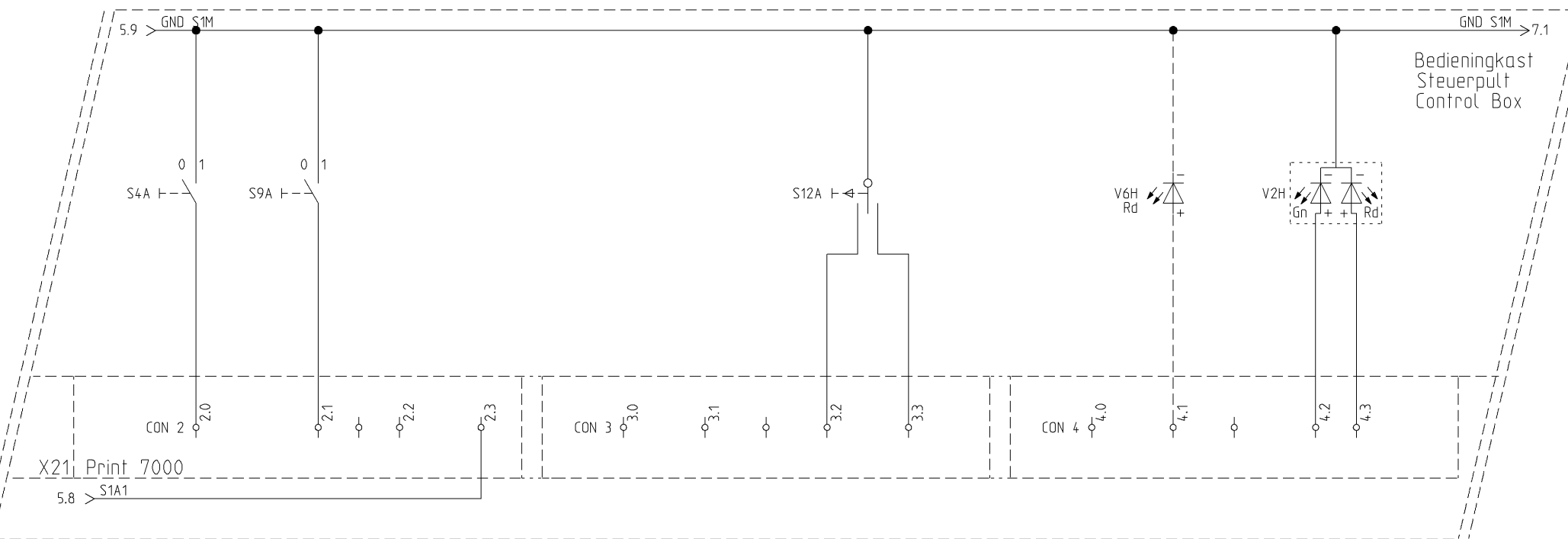

Bedieningkast
 Steuerpult
 Control Box

X21, Print 7000

S4A
 0 = Langzaam Langsam Slow
 1 = Snel Schnell Fast

S9A
 0 = Laag Niedrig Low
 1 = Autom. Autom. Autom.

V2H
 gn: Scheef. 1 & 2 OK gl: Scheef. 2 net OK rd: Scheef. 1 & 2 net OK
 gn: Neigung 1 & 2 OK gl: Neigung 2 nicht OK rd: Neigung 1 & 2 nicht OK
 gn: Tilt 1 & 2 OK yl: Tilt 2 not OK rd: Tilt 1 & 2 not OK

5.9 > GND

GND > 7.0

Snelheid
 Geschwindigkeit
 Speed

Toerental
 Drehzahl
 Enging Speed

S1A1 Dodemansknop
 S1A1 Totmansknop
 S1A1 Dead Man,s Button

4xN-Stempels-Autom. Niveleer
 4xN-Stuetzen-Autom. Nivel.
 4xN-Jack-Autom. Nivel

Generator aan
 Generator ein
 Generator on
 Optie/Option

Scheefstand
 Neigung
 Grade/Slope

this drawing is property of Holland Lift International, by all rights reserved
 diese zeichnung ist eigentum von Holland Lift International, by all rights reserved
 deze tekening is eigendom van Holland Lift International, by auteursrecht voorbehouden volgens de wet



Holland Lift International B.V.
 Anodeweg 1
 NL-1627 LJ Hoorn The Netherlands
 T/F +31 (0)229-285555 / 285550
 E service@hollandlift.com
 W www.hollandlift.com

STROOMKRINGSHEMA
 STROMLAUFPLAN
 CIRCUIT DIAGRAM

Projekt: EQ-23-001
 Datum: 31.05.2017

Zeichnungsnummer:
 Anlage: =

Rev.: A
 Ort: +

erstellt von: Rothenbusch
 Blatt: 6

6.9 > +24V Converter
6.9 > +24V Emergency Stop

+24V Converter > 8.0
+24V Emergency Stop > 8.0

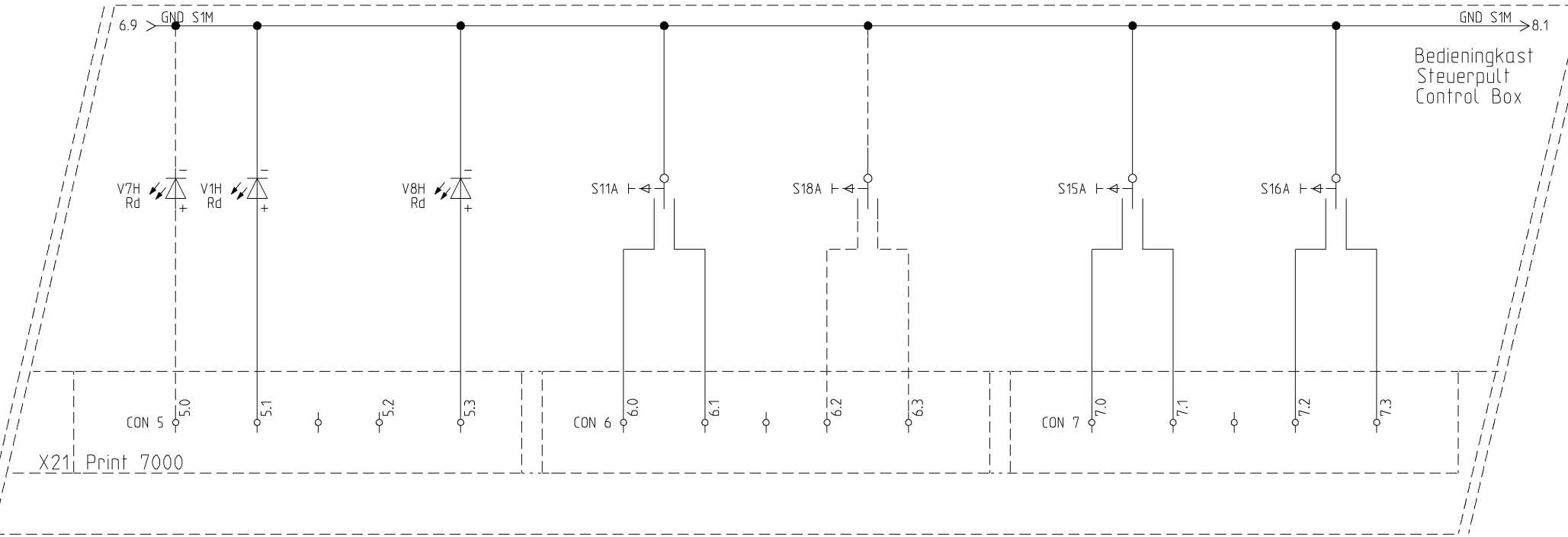

6.9 > GND GND > 8.0

Vetpomp
Fett Pumpe
Grease Pump

Overload
Ueberlastung
Overload

Tank leeg
Tank leer
Tank empty

Start - Motor - Stop
Start - Motor - Halt
Start - Engine - Stop

Aan Generator Uit
An Generator Aus
On Generator Off

LA in
LH ein
LR in

LA uit
LH aus
LR out

RA in
RH ein
RR in

RA uit
RH aus
RR out

Optie/Option

Optie/Option

Stempels-Stuetzen-Jacks Stempels-Stuetzen-Jacks

this drawing is property of Holland Lift International, by all rights reserved
 deze tekening is eigendom van Holland Lift International, by all rights reserved
 deze tekening is eigendom van Holland Lift International, by auteursrecht voorbehouden volgens de wet

HOLLAND LIFT

Holland Lift International B.V.
Anodeweg 1
NL-1627 LJ Hoorn The Netherlands
T/F +31 (0)229-285555 / 285550
E service@hollandlift.com
W www.hollandlift.com

STROOMKRINGSCHEMA
STROMLAUFPLAN
CIRCUIT DIAGRAM

Projekt:
EQ-23-001

Zeichnungsnummer:

Rev.: A

erstellt von:
Rothenbusch

Datum:
31.05.2017

Anlage:
=

Ort:
+

Blatt:
7

7.9 > +24V Converter
 7.9 > +24V Emergency Stop

+24V Converter > 9.0
 +24V Emergency Stop > 9.0

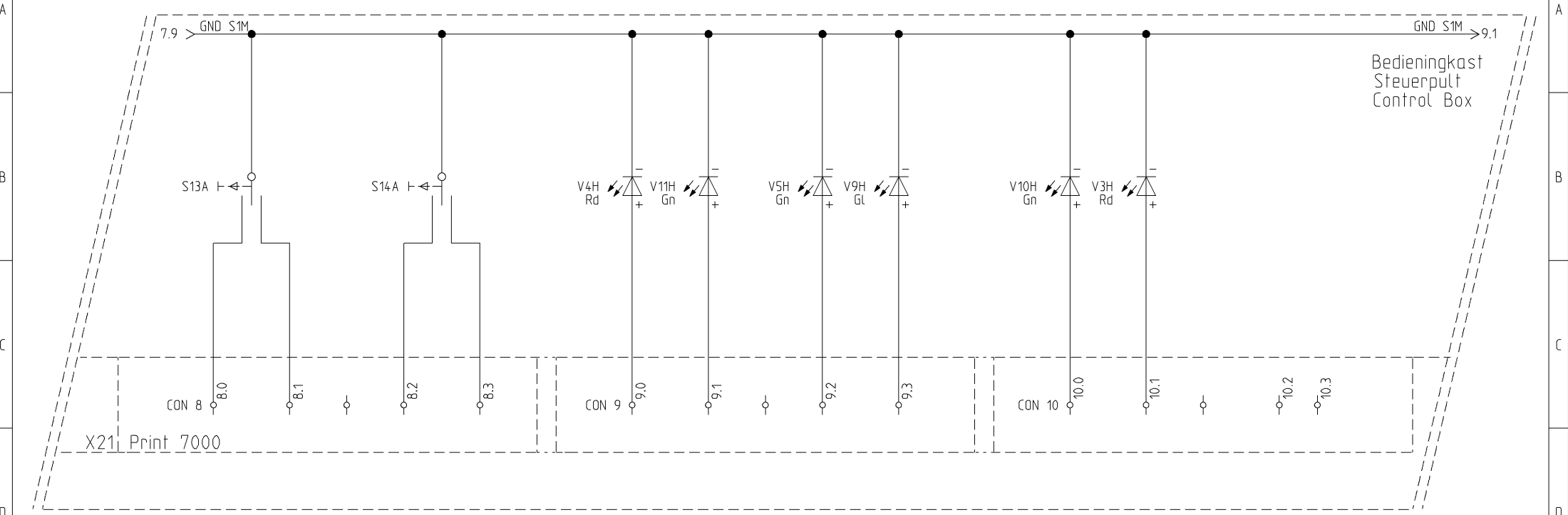

7.9 > GND

GND > 9.0

LV in LV ein LF in	LV uit LV aus LF out	RV in RV ein RF in	RV uit RV aus RF out	Pendelas Horizontaal Pendel Achse Hor. Oscillating Axle Hor.	Stempels in Stuetzen ein Jacks in	Stempels uit Stuetzen aus Jacks out	Autom. Niv. Autom. Niv. Autom. Niv.	In Bedrijf In Betrieb Run	Storing Stoerung Failure
Stempels-Stuetzen-Jacks				Stempels-Stuetzen-Jacks				Diesel Motor	

this drawing is property of Holland Lift International, by all rights reserved
 deze tekening is eigendom van Holland Lift International, by all rights reserved
 deze tekening is eigendom van Holland Lift International, by auteursrecht voorbehouden volgens de wet

8.9 > +24V Converter
 8.9 > +24V Emergency Stop

+24V Converter > 10.0
 +24V Emergency Stop > 10.0
 +24V U3 > 10.0

Bedieningkast
 Steerpult
 Control Box

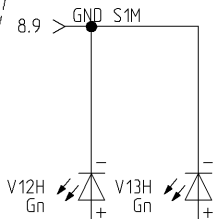

CON 11

11.0

11.1

11.2

11.3

X21, Print 7000

2.2 > +W

PRINT HY001



S > 10.2
 U > 10.2

Speed Diesel > 11.0

8.9 > GND

GND > 10.0

Rijden/Sturen Heffen/Dalen
 Fahren/Lenken Heben/Senken
 Driving/Steering Lift Up/Lift Down

this drawing is property of Holland Lift International, by all rights reserved.
 deze tekening is eigendom van Holland Lift International, by auteursrecht voorbehouden volgens de wet.
 deze tekening is eigendom van Holland Lift International, by auteursrecht voorbehouden volgens de wet.

this drawing is property of Holland Lift International, by all rights reserved.
 deze tekening is eigendom van Holland Lift International, by all rights reserved.
 deze tekening is eigendom van Holland Lift International, by all rights reserved.

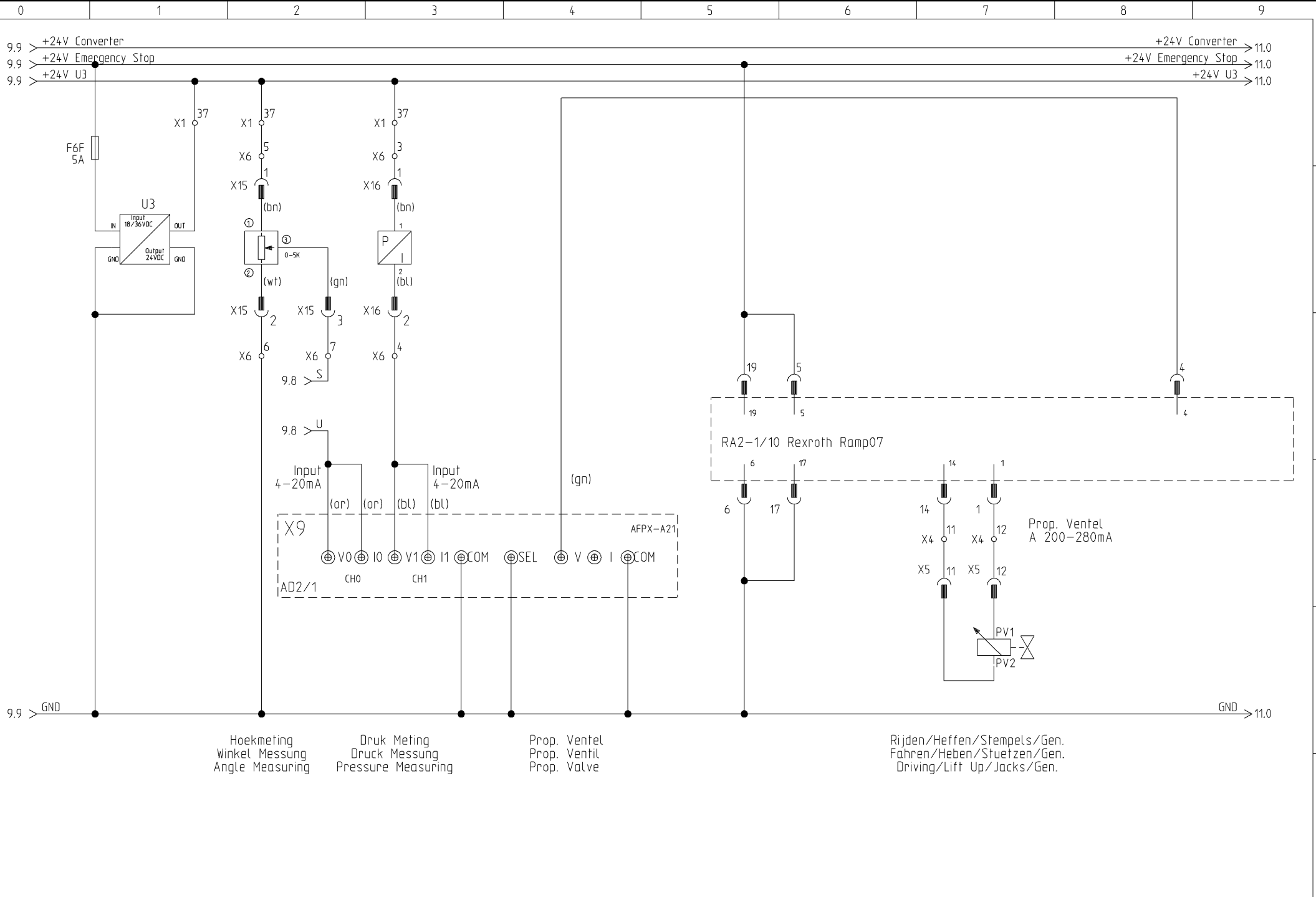

Hoekmeting
Winkel Messung
Angle Measuring

Druk Meting
Druck Messung
Pressure Measuring

Prop. Ventel
Prop. Ventil
Prop. Valve

Rijden/Heffen/Stempels/Gen.
Fahren/Heben/Stuetzen/Gen.
Driving/Lift Up/Jacks/Gen.

this drawing is property of Holland Lift International, by all rights reserved.
 deze tekening is eigendom van Holland Lift International, by all rights reserved.
 deze tekening is eigendom van Holland Lift International, by auteursrecht voorbehouden volgens de wet

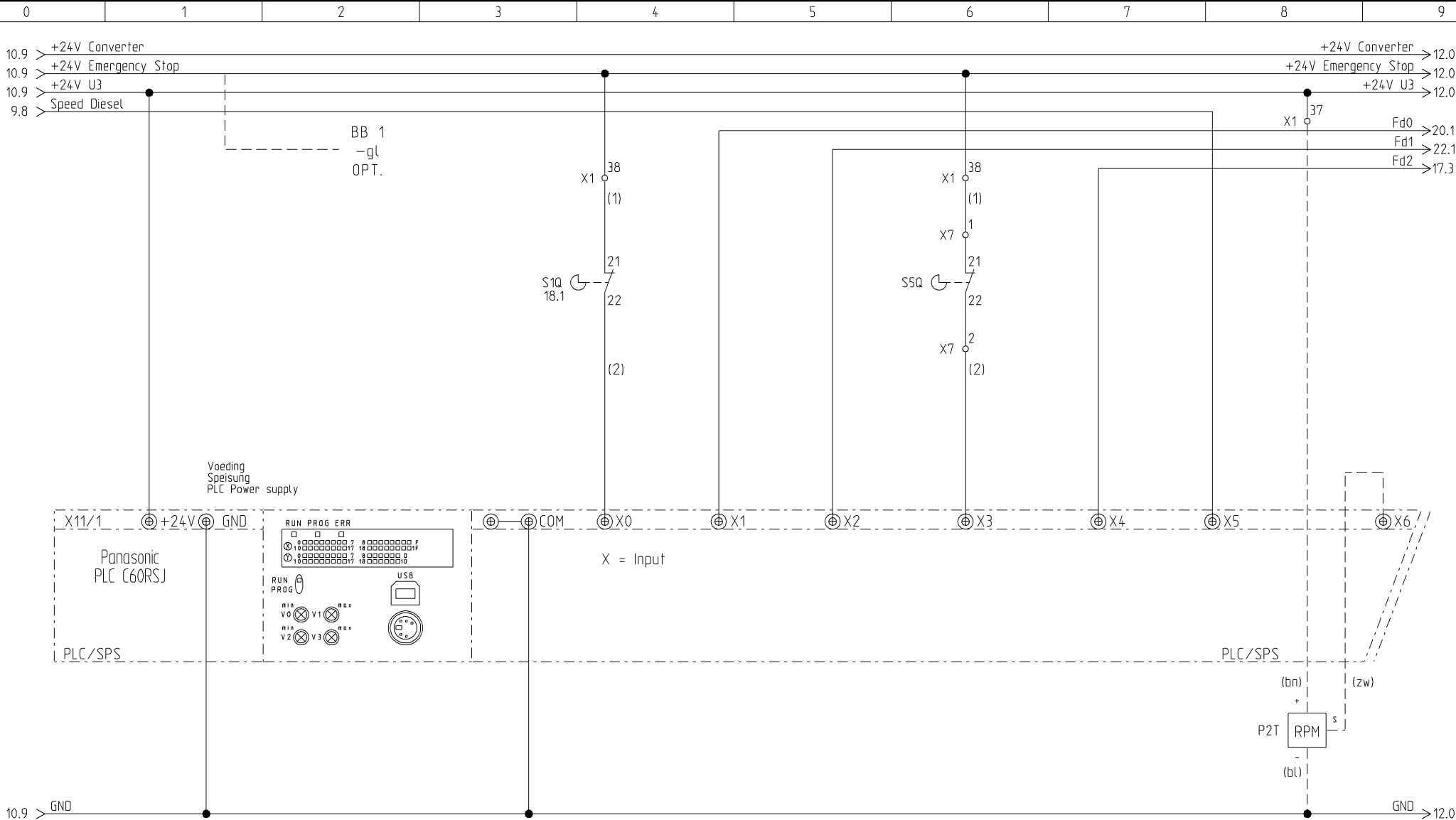

- 4 mtr. Afslag Feedback In 0
- 4 mtr. Ausschalt. Feedback In 0
- 4 mtr. Cut-Out Feedback In 0
- Feedback In 1 Pendelas Horizontaal
- Feedback In 1 Pendel Achse Hor.
- Feedback In 1 Oscillating Axle Hor.
- Feedback In 2 Toeren D.
- Feedback In 2 Drehzahl D.
- Feedback In 2 Speed D.
- RPM Teller Gen.
- RPM Zaehler Gen.
- RPM Meter Gen.

Optie/Option



Holland Lift International B.V.
 Anodeweg 1
 NL-1627 LJ Hoorn The Netherlands
 T/F +31 (0)229-285555 / 285550
 E service@hollandlift.com
 W www.hollandlift.com

STROOMKRINGSHEMA
 STROMLAUFPLAN
 CIRCUIT DIAGRAM

Projekt:	EQ-23-001	Zeichnungsnummer:	Rev.:	A	erstellt von:	Rothenbusch
Datum:	31.05.2017	Anlage:	Ort:	=	Blatt:	11

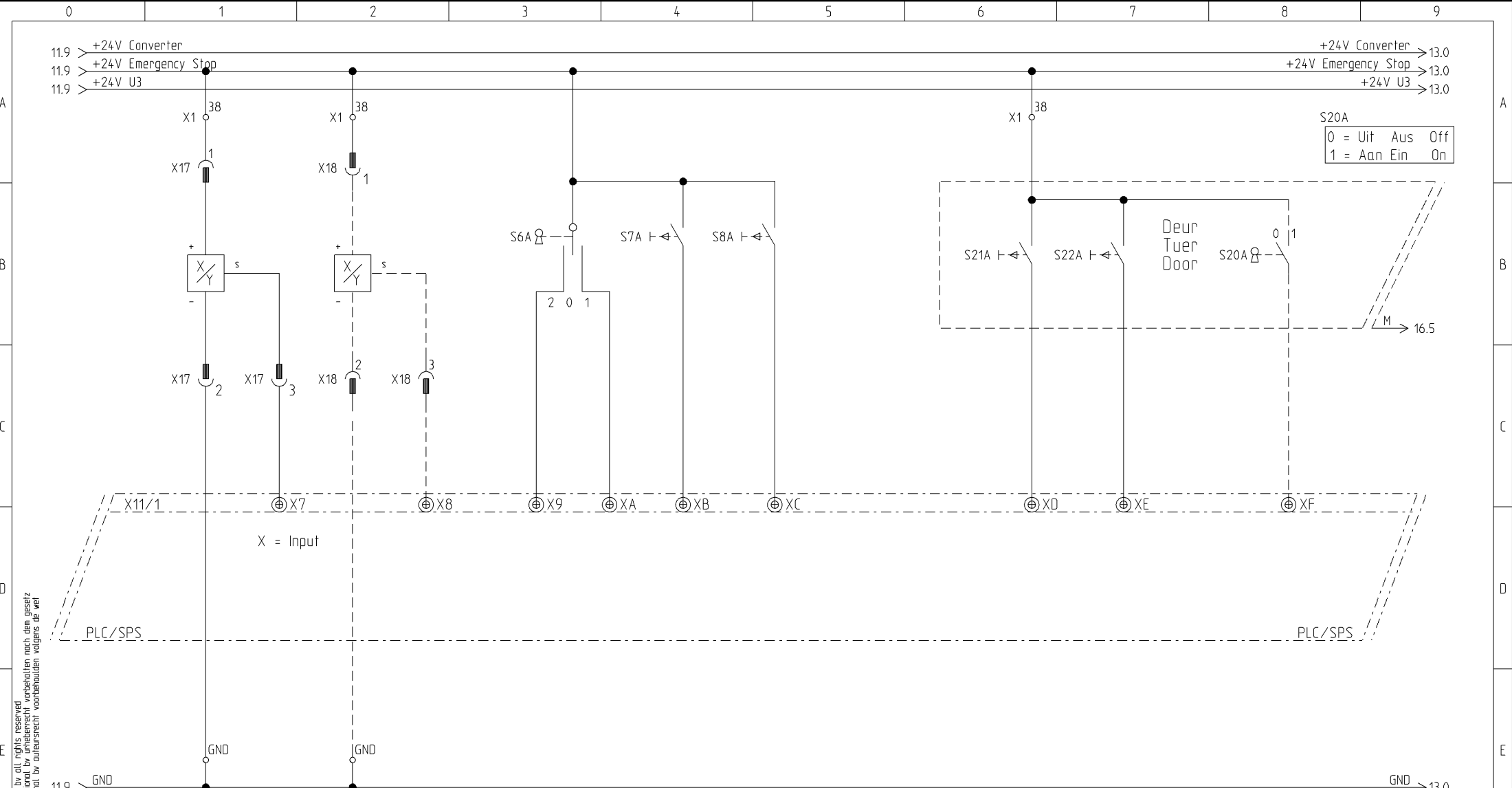

Scheefstand 1 Scheefstand 2
 Neiging 1 Neiging 2
 Grade/Slope 1 Grade/Slope 2

Progr. Uit Aan Store Save
 Progr. Aus An Store Save
 Progr. Off On Store Save

Start - Motor - Stop
 Start - Motor - Halt
 Start - Engine - Stop

Ri. max. Hoogte
 Fa. max. Hoehe
 Dr. max. Height

Optie/Option — Overlast—Ueberlastung—Overload — Optie/Option



Holland Lift International B.V.
 Anodeweg 1
 NL-1627 LJ Hoorn The Netherlands
 T/F +31 (0)229-285555 / 285550
 E service@hollandlift.com
 W www.hollandlift.com

STROOMKRINGSCHEMA
 STROMLAUFPLAN
 CIRCUIT DIAGRAM

Projekt: EQ-23-001	Zeichnungsnummer:	Rev.: A	erstellt von: Rothenbusch
Datum: 31.05.2017	Anlage: =	Ort: +	Blatt: 12

this drawing is property of Holland Lift International. All rights reserved.
 deze tekening is eigendom van Holland Lift International. Alle rechten voorbehouden.
 deze tekening is eigendom van Holland Lift International. Alle rechten voorbehouden volgens de wet.

this drawing is property of Holland Lift International, by all rights reserved.
 deze tekening is eigendom van Holland Lift International, by all rights reserved.
 deze tekening is eigendom van Holland Lift International, by all rights reserved.

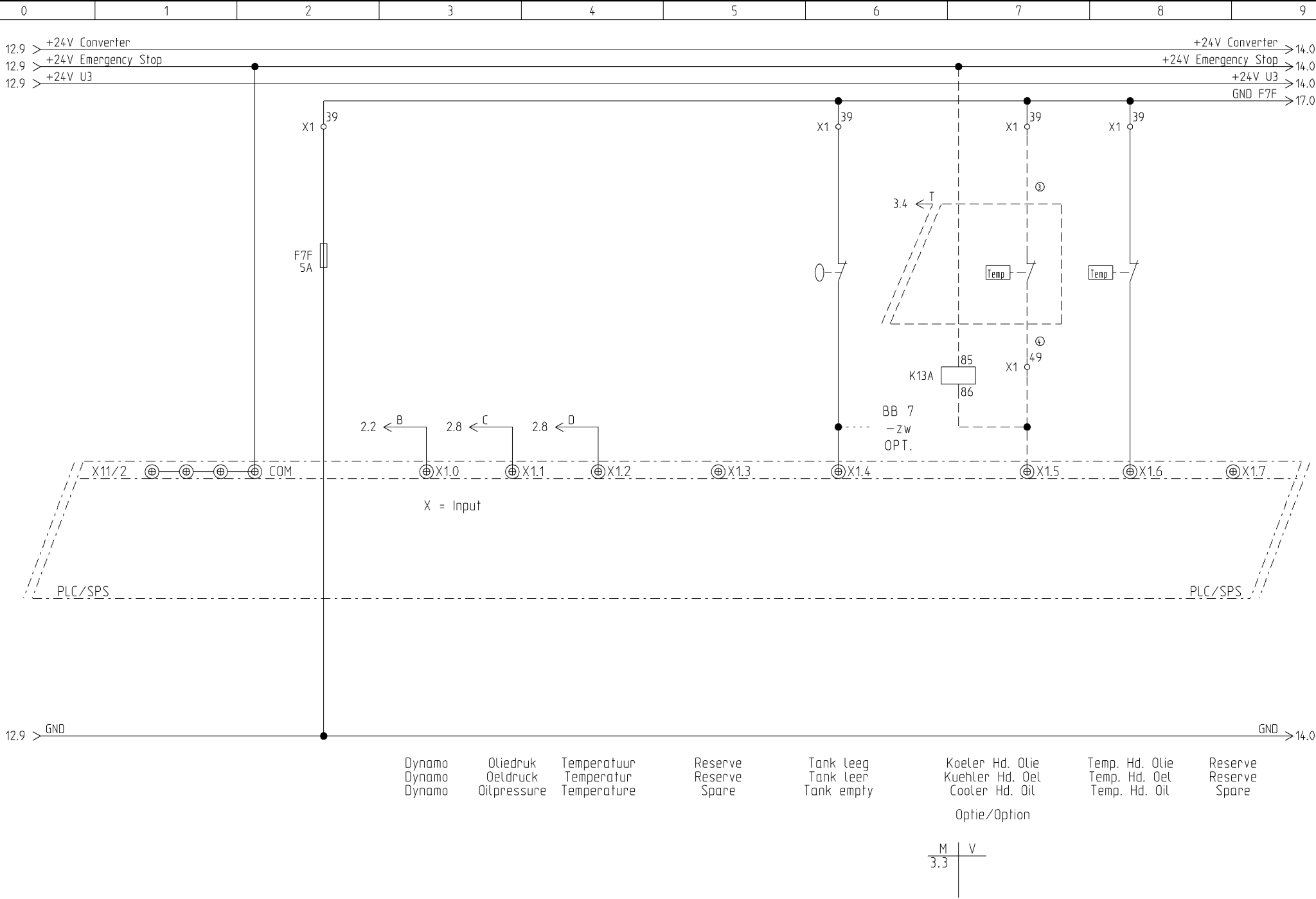

Holland Lift International B.V.
 Anodeweg 1
 NL-1627 LJ Hoorn The Netherlands
 T/F +31 (0)229-285555 / 285550
 E service@hollandlift.com
 W www.hollandlift.com

STROOMKRINGSHEMA
 STROMLAUFPLAN
 CIRCUIT DIAGRAM

Projekt: EQ-23-001	Zeichnungsnummer:	Rev.: A	erstellt von: Rothenbusch
Datum: 31.05.2017	Anlage: =	Ort: +	Blatt: 13

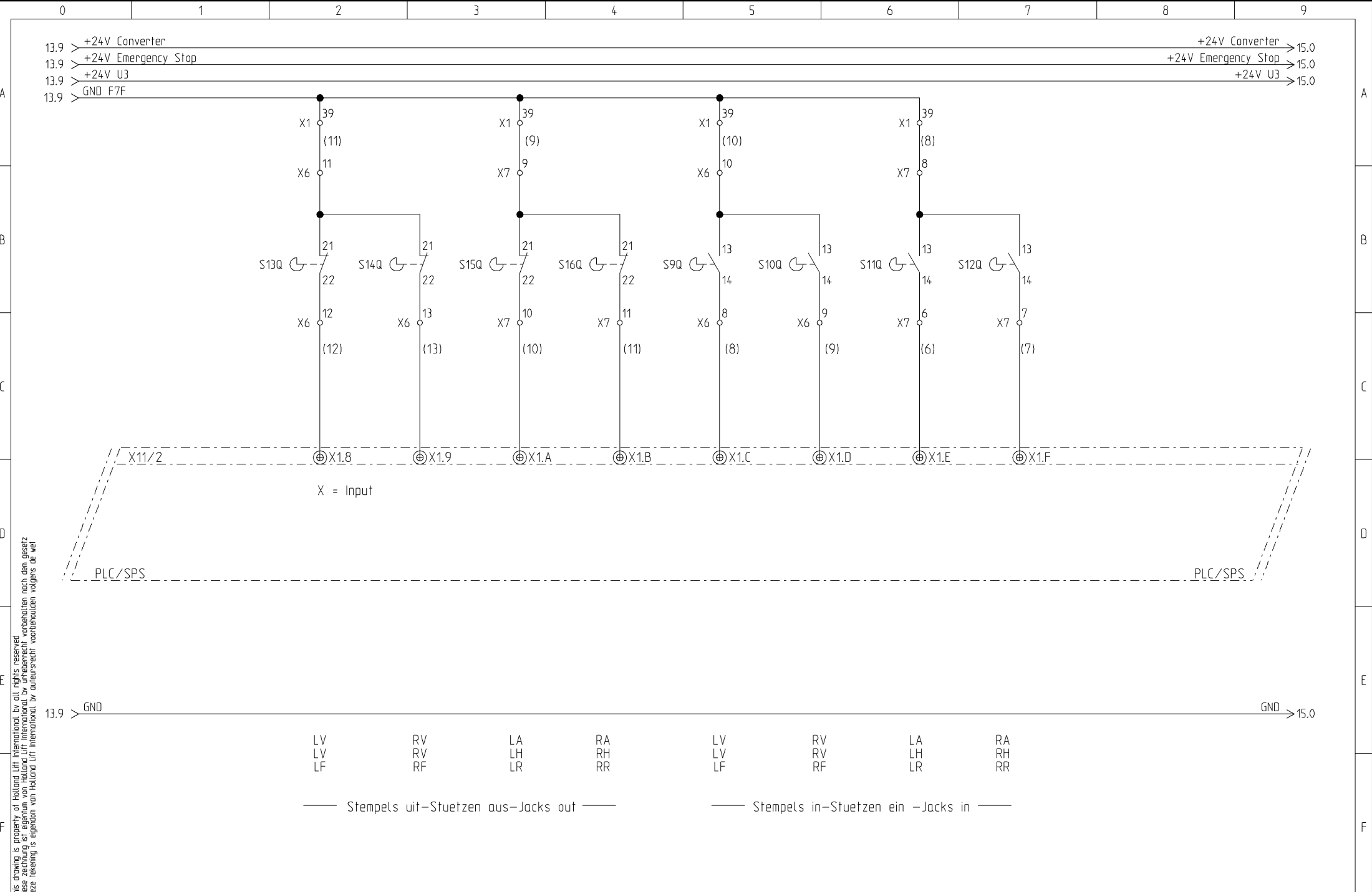

this drawing is property of Holland Lift International, by all rights reserved
 deze tekening is eigendom van Holland Lift International, by all rights reserved
 deze tekening is eigendom van Holland Lift International, by all rights reserved



Holland Lift International B.V.
 Anodeweg 1
 NL-1627 LJ Hoorn The Netherlands
 T/F +31 (0)229-285555 / 285550
 E service@hollandlift.com
 W www.hollandlift.com

STROOMKRINGSCHMA
 STROMLAUFPLAN
 CIRCUIT DIAGRAM

Projekt:	EQ-23-001	Zeichnungsnummer:	Rev.:	A	erstellt von:	Rothenbusch	
Datum:	31.05.2017	Anlage:	=	Ort:	+	Blatt:	14

this drawing is property of Holland Lift International, by all rights reserved
 deze tekening is eigendom van Holland Lift International, by auteursrecht voorbehouden volgens de wet

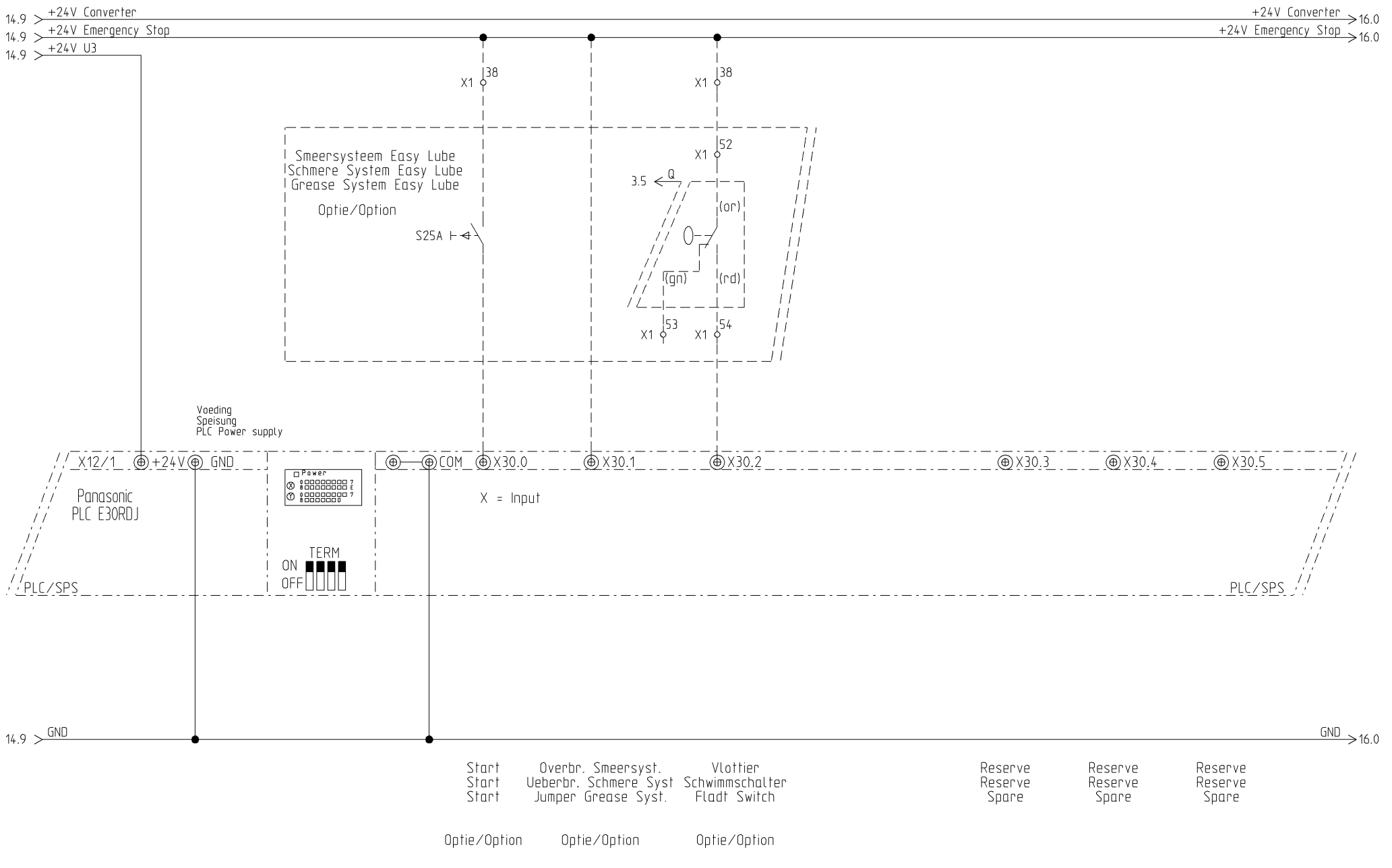

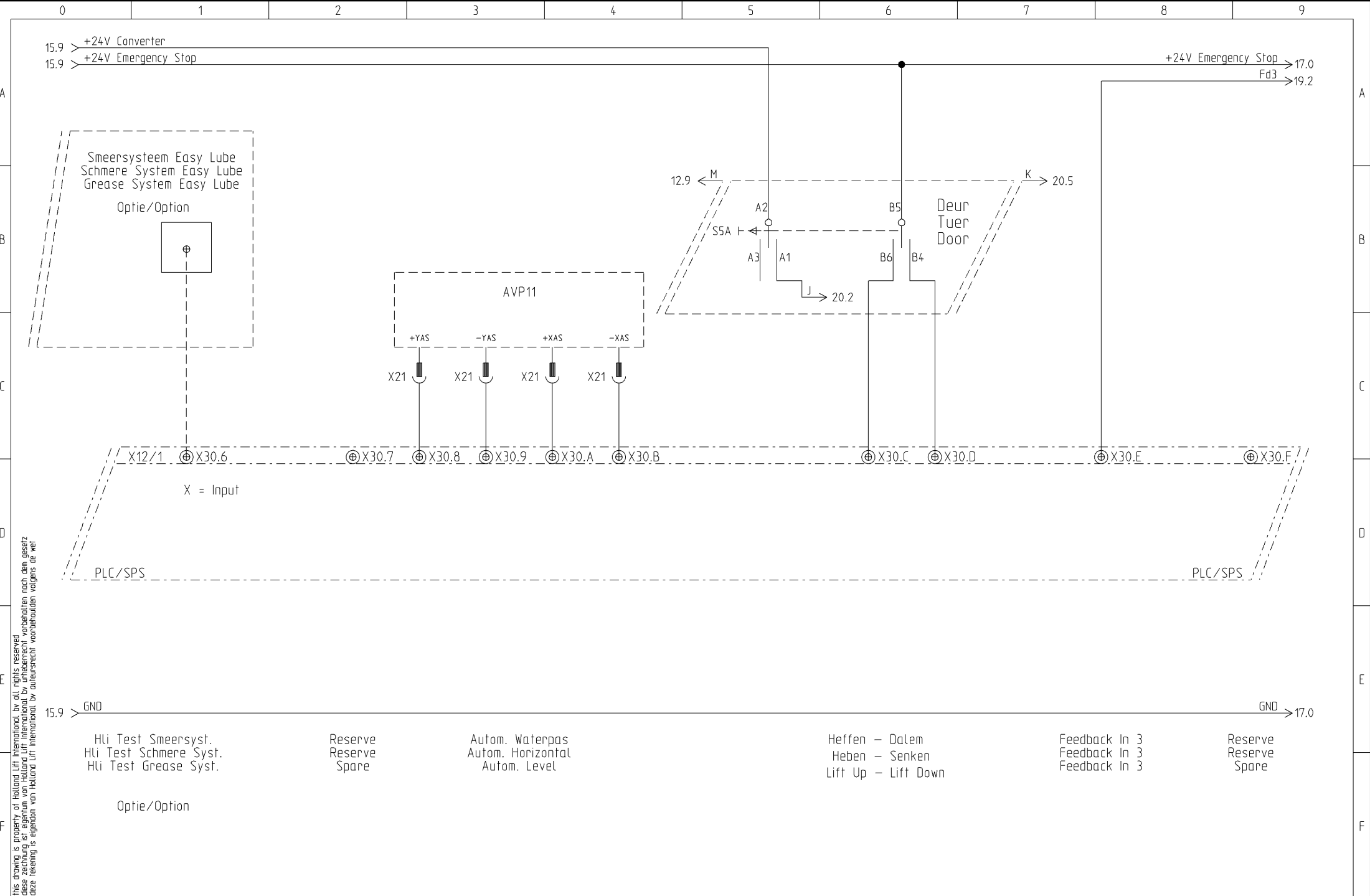

this drawing is property of Holland Lift International, by all rights reserved.
 deze tekening is eigendom van Holland Lift International, by all rights reserved.
 deze tekening is eigendom van Holland Lift International, by all rights reserved.

this drawing is property of Holland Lift International, by all rights reserved.
 diese zeichnung ist eigentum von Holland Lift International, by alle rechte vorbehalten nach dem gesetz.
 deze tekening is eigendom van Holland Lift International, by auteursrecht voorbehouden volgens de wet.

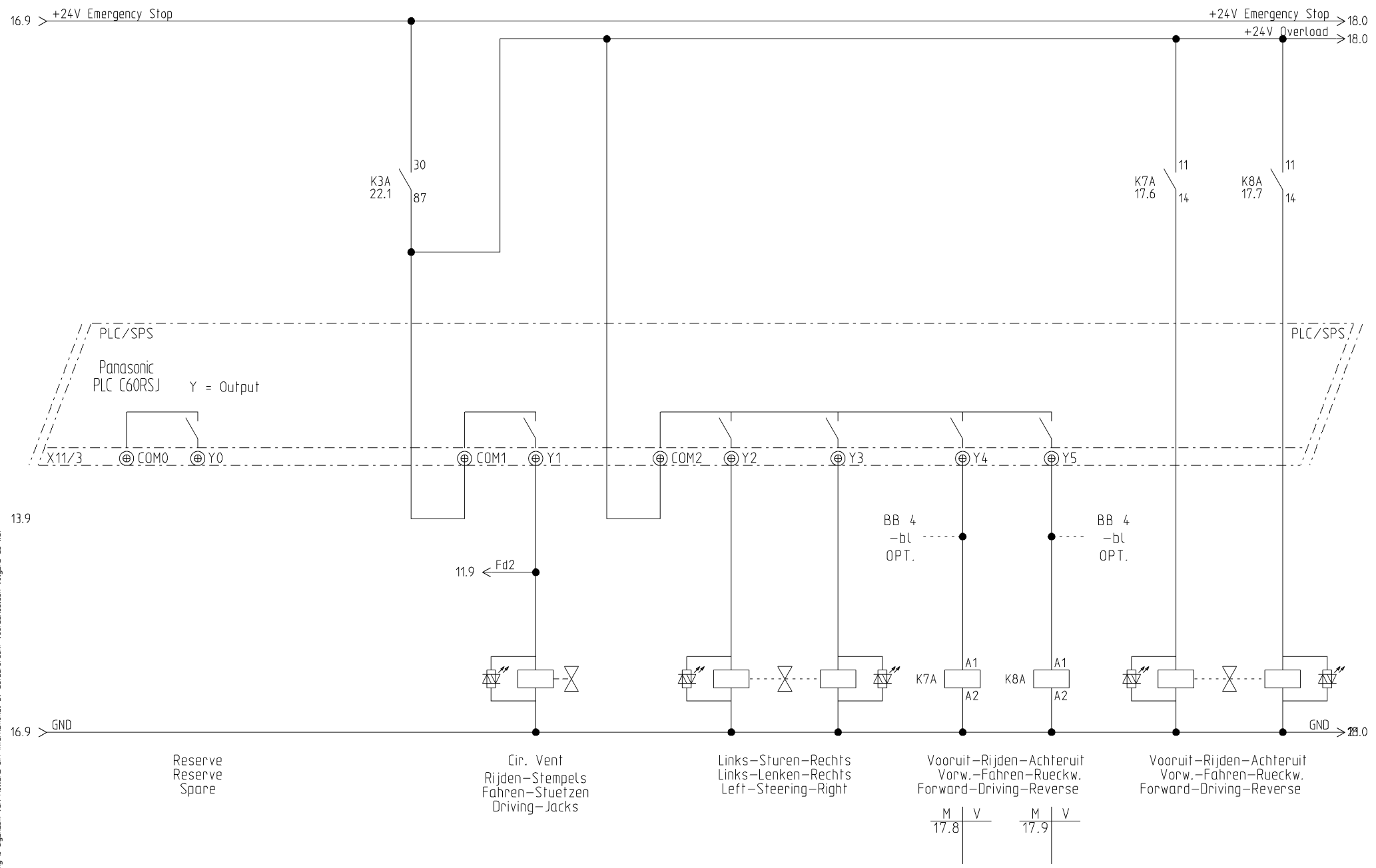

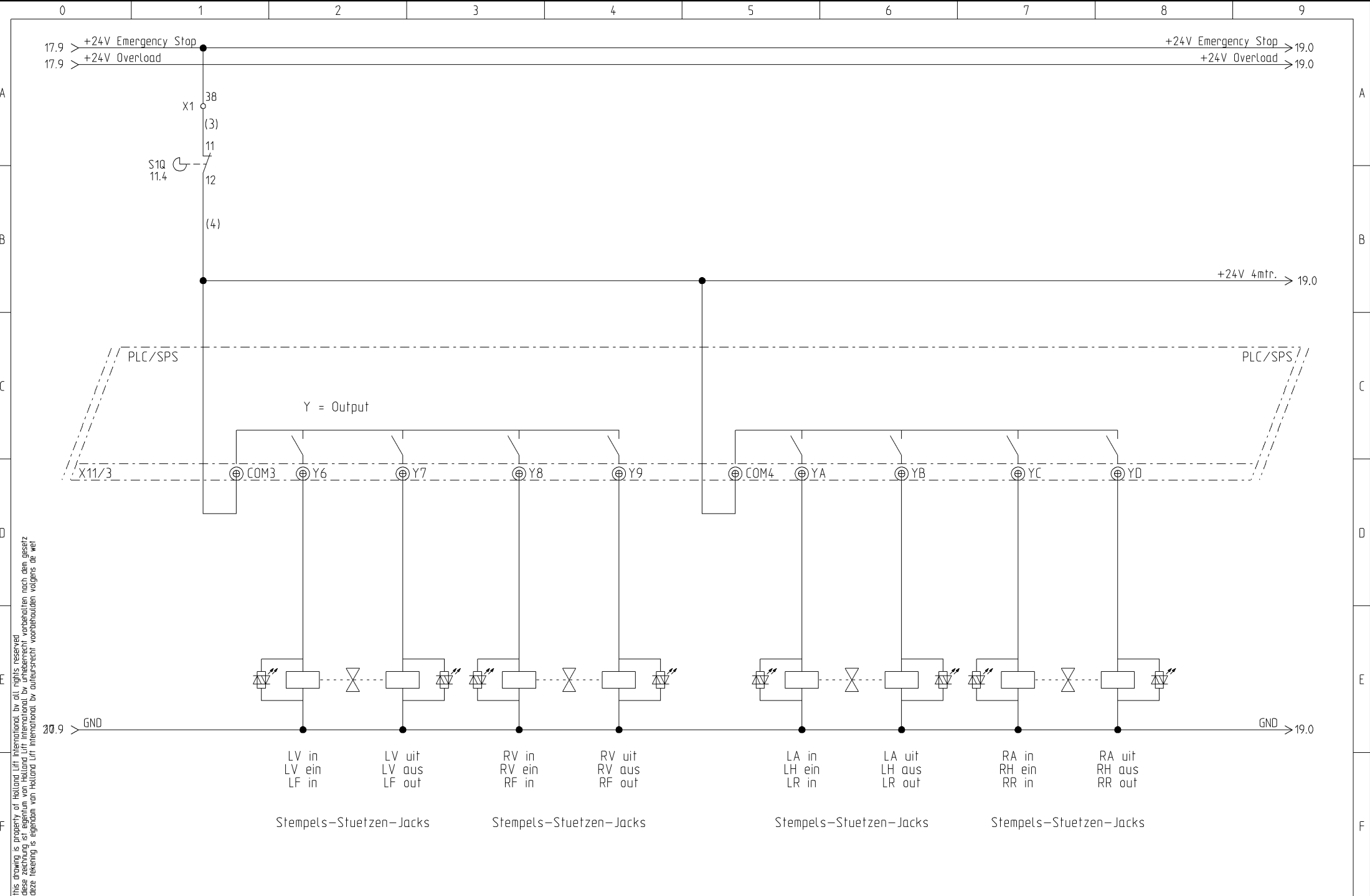

this drawing is property of Holland Lift International. All rights reserved.
 deze tekening is eigendom van Holland Lift International. Alle rechten voorbehouden.
 deze tekening is eigendom van Holland Lift International. Alle rechten voorbehouden volgens de wet.



Holland Lift International B.V.
 Anodeweg 1
 NL-1627 LJ Hoorn The Netherlands
 T/F +31 (0)229-285555 / 285550
 E service@hollandlift.com
 W www.hollandlift.com

STROOMKRINGSCHEMA
 STROMLAUFPLAN
 CIRCUIT DIAGRAM

Projekt:	EQ-23-001	Zeichnungsnummer:	Rev.:	A	erstellt von:	Rothenbusch
Datum:	31.05.2017	Anlage:	Ort:	=	Blatt:	18

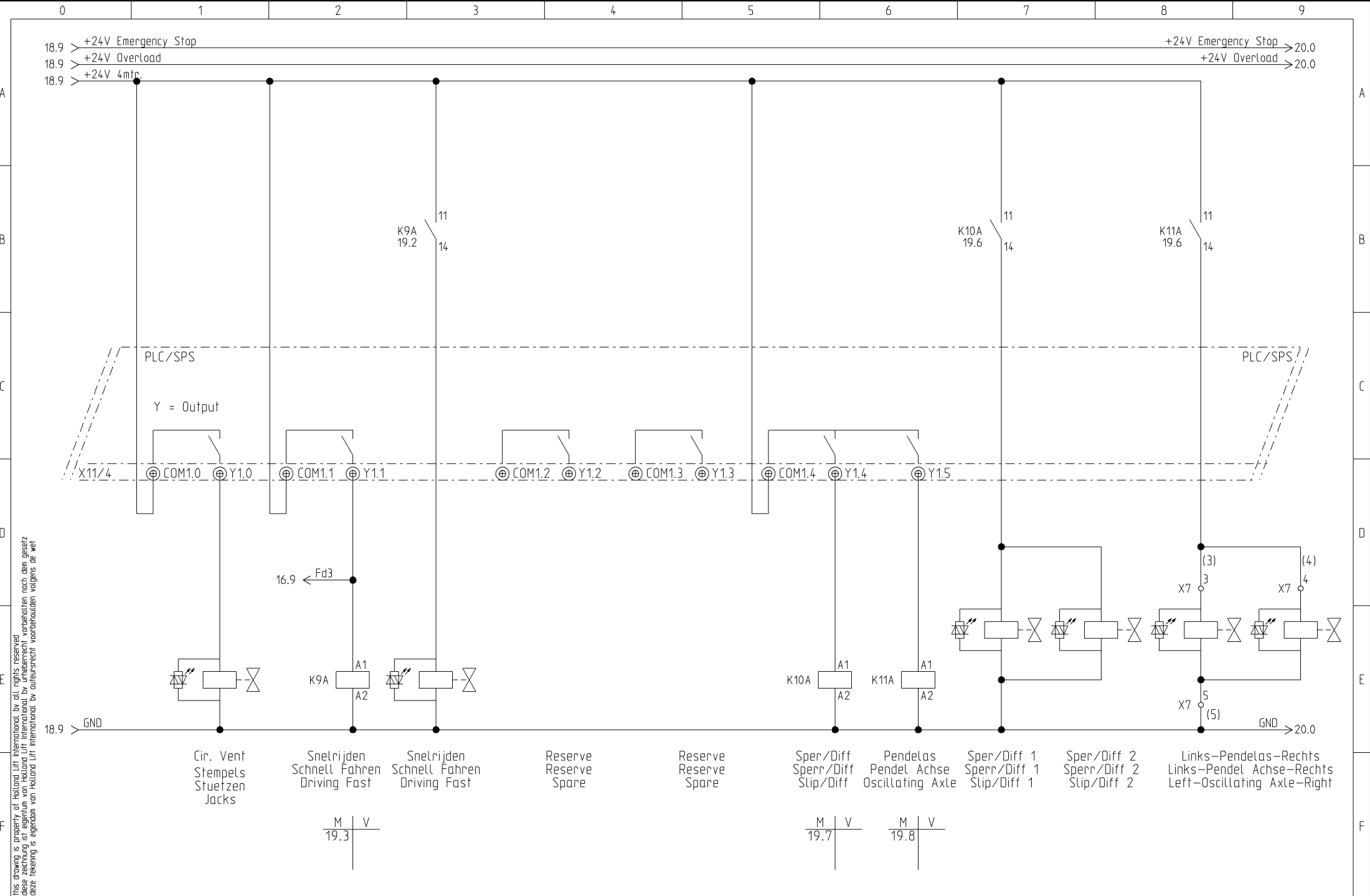

this drawing is property of Holland Lift International, by all rights reserved.
 deze tekening is eigendom van Holland Lift International, by all rights reserved.
 deze tekening is eigendom van Holland Lift International, by all rights reserved.



Holland Lift International B.V.
 Anodeweg 1
 NL-1627 LJ Hoorn The Netherlands
 T/F +31 (0)229-285555 / 285550
 E service@hollandlift.com
 W www.hollandlift.com

STROOMKRINGSHEMA
 STROMLAUFPLAN
 CIRCUIT DIAGRAM

Projekt: EQ-23-001	Zeichnungsnummer:	Rev.: A	erstellt von: Rothenbusch
Datum: 31.05.2017	Anlage: =	Ort: +	Blatt: 19

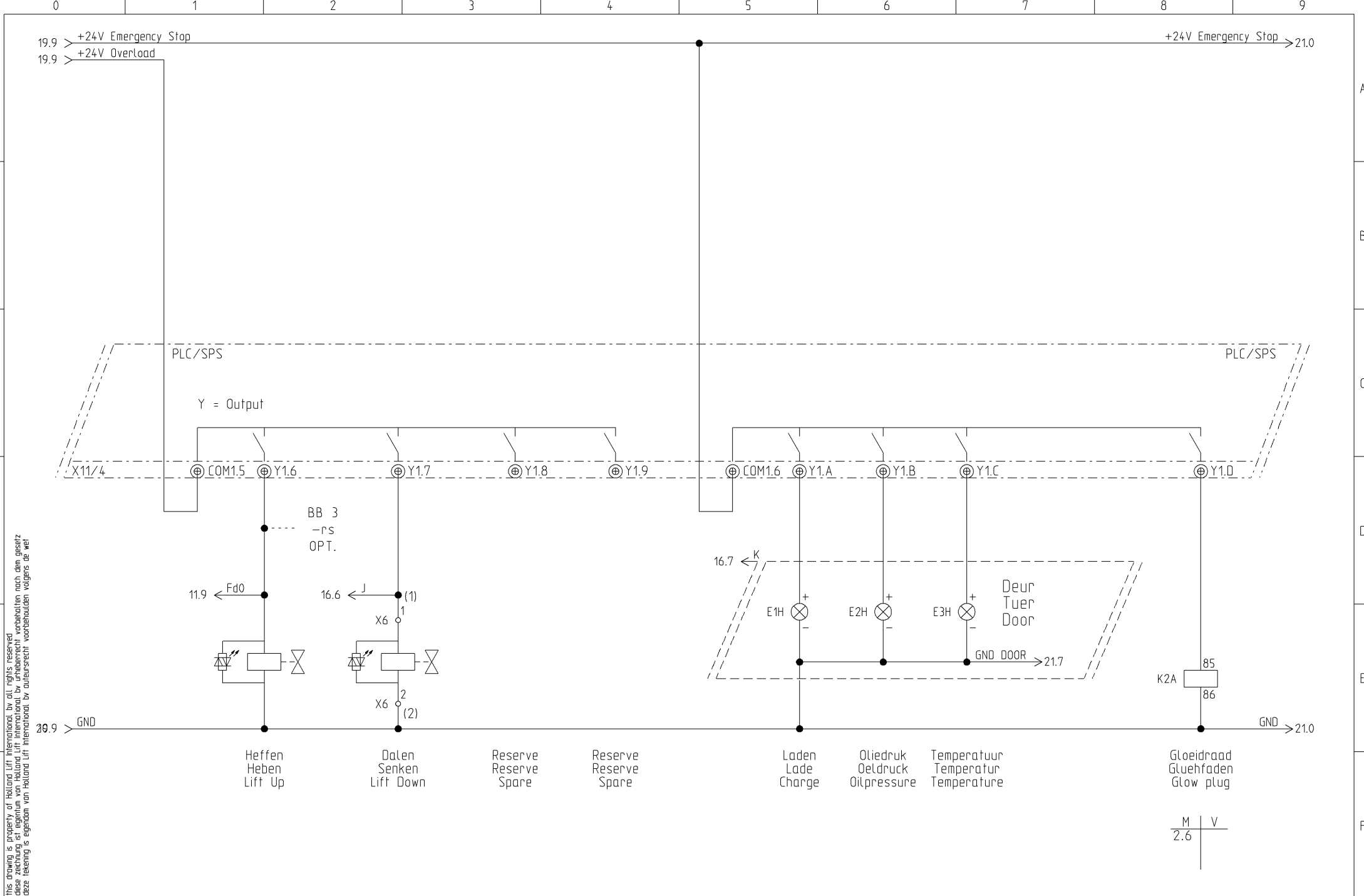

this drawing is property of Holland Lift International, by all rights reserved
 deze tekening is eigendom van Holland Lift International, by all rights reserved
 deze tekening is eigendom van Holland Lift International, by all rights reserved



Holland Lift International B.V.
 Anodeweg 1
 NL-1627 LJ Hoorn The Netherlands
 T/F +31 (0)229-285555 / 285550
 E service@hollandlift.com
 W www.hollandlift.com

STROOMKRINGSHEMA
 STROMLAUFPLAN
 CIRCUIT DIAGRAM

Projekt:	EQ-23-001	Zeichnungsnummer:	Rev.:	A	erstellt von:	Rothenbusch
Datum:	31.05.2017	Anlage:	Ort:	=	Blatt:	20

this drawing is property of Holland Lift International, by all rights reserved.
 deze tekening is eigendom van Holland Lift International, by all rights reserved.
 deze tekening is eigendom van Holland Lift International, by auteursrecht voorbehouden volgens de wet

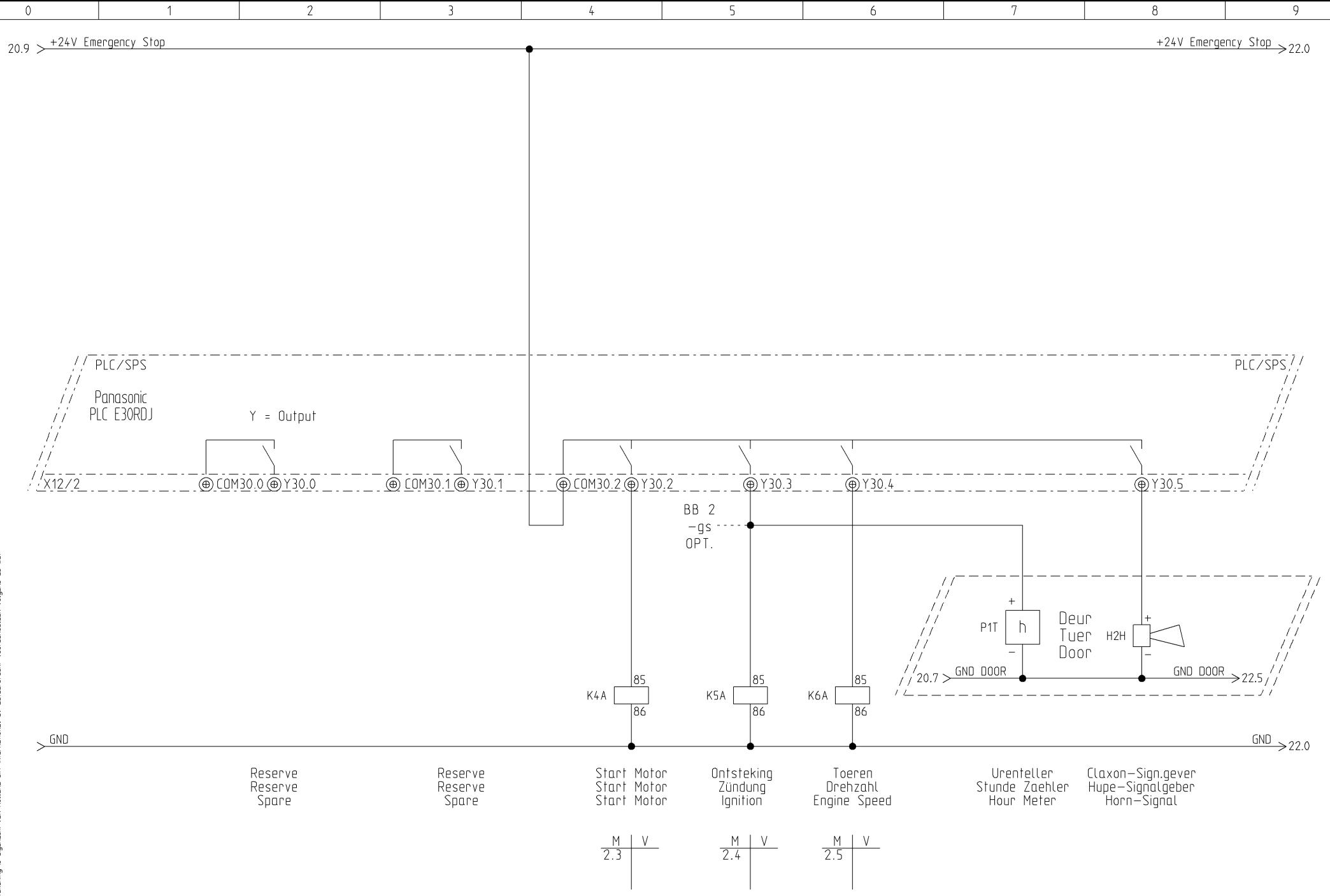

this drawing is property of Holland Lift International. All rights reserved.
 deze tekening is eigendom van Holland Lift International. Alle rechten voorbehouden.
 deze tekening is eigendom van Holland Lift International. Alle rechten voorbehouden volgens de wet

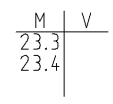
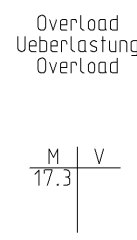
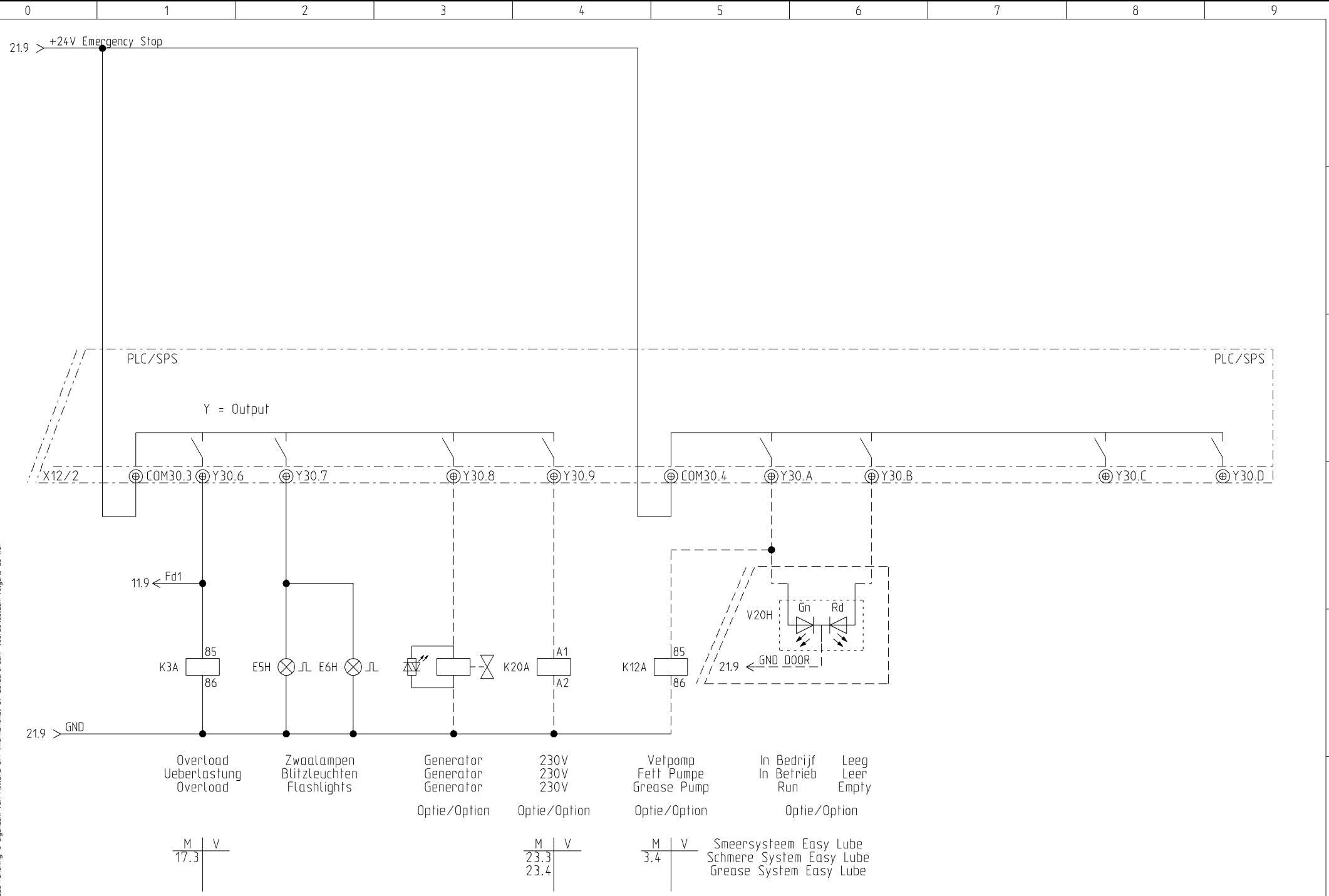

OPTIES
OPTIONEN
OPTIONS

230V AANSLUITING PLATFORM
230V ANSCHLUSS PLATTFORM
230V SUPPLY PLATFORM

<230VPLF>

230V-50Hz/115V-50Hz

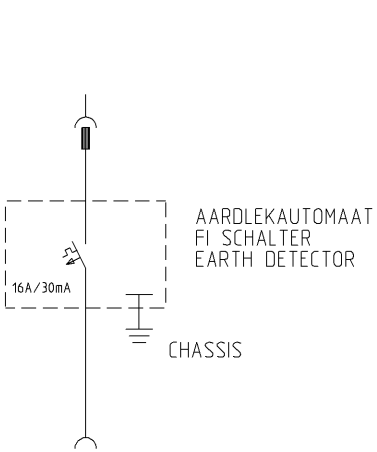

230V AANSLUITING PLATFORM
230V ANSCHLUSS PLATTFORM
230V SUPPLY PLATFORM

<230V-GEN>

230V-50Hz/115V-50Hz

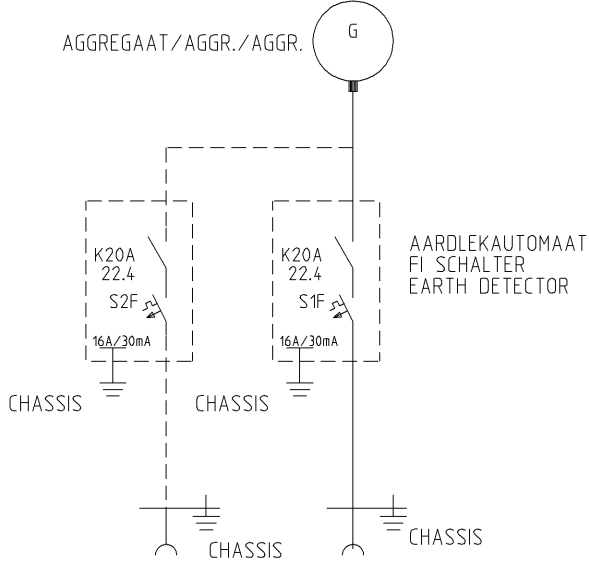

OPTIE BLACK-BOX MINI DAT
OPTION BLACK-BOX MINI DAT
OPTION BLACK-BOX MINI DAT

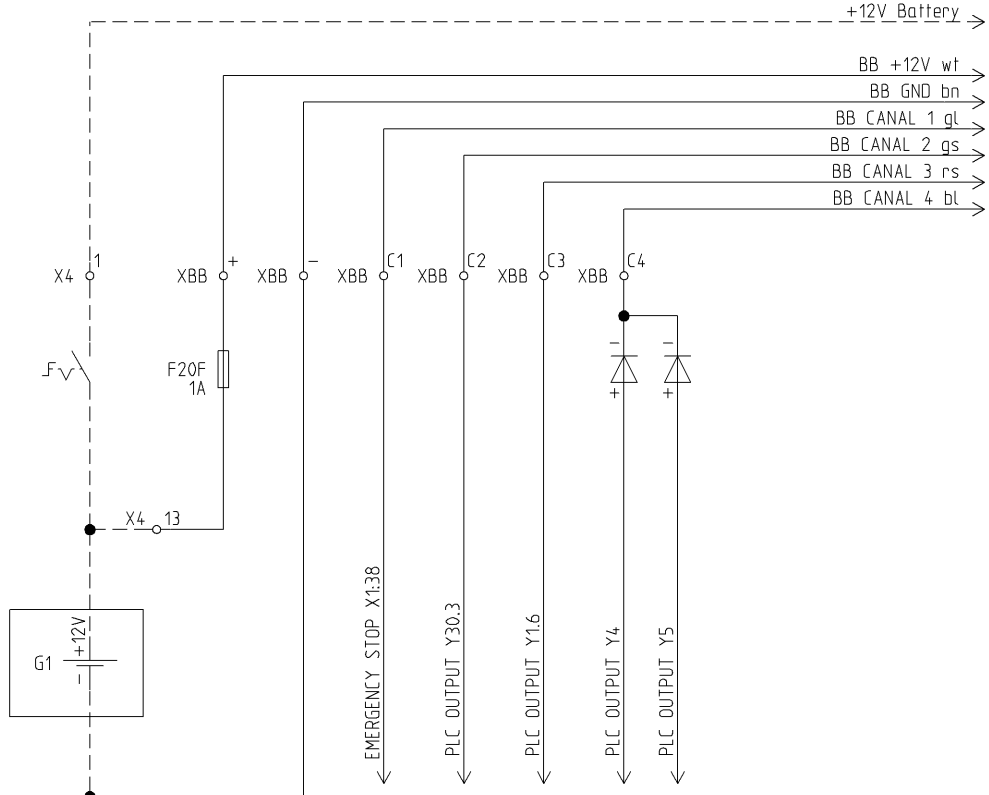

BB-wf	+24V DC	+24V DC	+24V DC	+24V DC
BB-bn	GND	GND	GND	GND
BB-gl	CH1	NOOD-STOP	NOT-AUS	EMERGENCY STOP
BB-gs	CH2	DIESEL AAN	DIESEL EIN	DIESEL ON
BB-rs	CH3	HEFFEN	HEBEN	LIFT UP
BB-bl	CH4	RIJDEN	FAHREN	DRIVING
BB-rd	CH5	RESERVE	RESERVE	SPARE

this drawing is property of Holland Lift International, by all rights reserved
 diese zeichnung ist eigentum von Holland Lift International, by urheberrecht vorbehalten nach dem gesetz
 deze tekening is eigendom van Holland Lift International, by auteursrecht voorbehouden volgens de wet

KLEMMENKAST

KLEMMENKASTEN

CONNECTION BOX

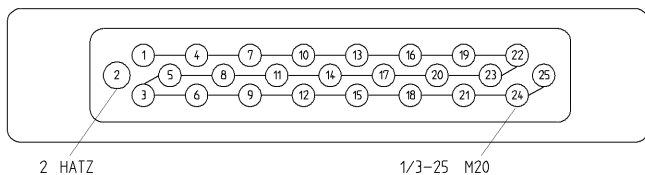
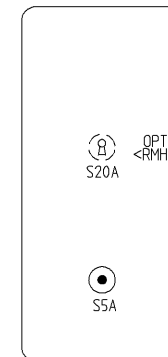
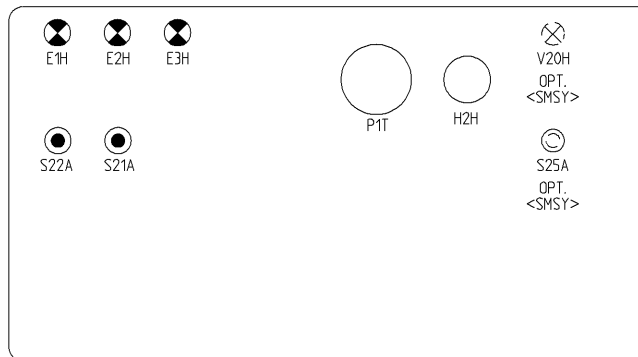
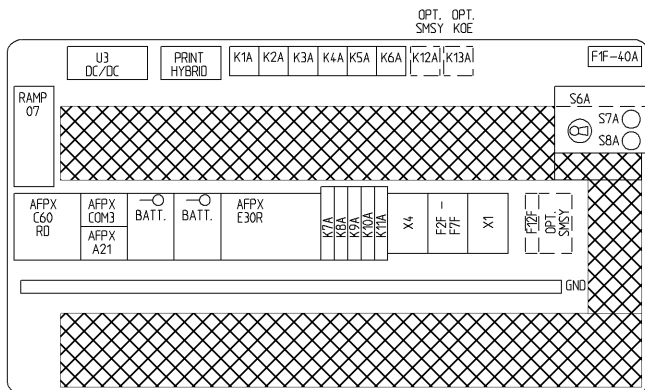

Colour schedule			
Colour	Dutch	English	Deutsch
Rd	Rood	Red	Rot
Bl	Blauw	Blue	Blau
Gl	Geel	Yellow	Gelb
Gn	Groen	Green	Gruen
Zw	Zwart	Black	Schwarz
Wt	Wit	White	Weiss
Bn	Bruin	Brown	Braun
Rs	Roze	Pink	Rosa
Or	Oranje	Orange	Orange
Ps	Paars	Violet	Violett
Tp	Transp.	Transp.	Transp.
Gs	Grijs	Grey	Grau

X4				X1																			
1	4	13	14	15	2	3	5	6	7	31	32	33	37	38	38	38	39						
					8	9	10	11	12	F2F 20A	F3F 20A	F4F 20A	F5F 5A	F6F 5A	F7F 5A	34	35	36	37	38	38	38	39
1	4	13	14	15	8	9	10	11	12	34	35	36	37	38	38	38	39						
					2	3	5	6	7	31	32	33	37	38	38	38	39						

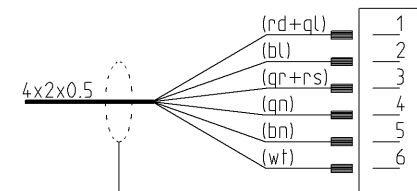
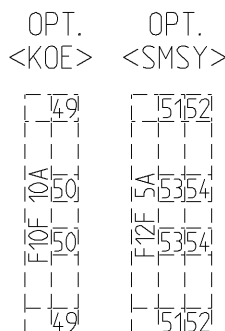

Afscherming niet aansluiten (aftapen)

AANSLUITING OP PLATFORM
ANSCHLUSS AUF PLATTFORM
CONNECTION ON PLATFORM

this drawing is property of Holland Lift International, by all rights reserved.
 deze tekening is eigendom van Holland Lift International, by auteursrecht voorbehouden volgens de wet.
 deze tekening is eigendom van Holland Lift International, by auteursrecht voorbehouden volgens de wet.



Holland Lift International B.V.
 Anodeweg 1
 NL-1627 LJ Hoorn The Netherlands
 T/F +31 (0)229-285555 / 285550
 E service@hollandlift.com
 W www.hollandlift.com

KASTEN/BEKABELING
 KASTEN/KABEL
 BOXES/CABLES

Projekt: EQ-23-001
 Datum: 31.05.2017

Zeichnungsnummer:
 Anlage:
 Ort: =

Rev.: A
 +

erstellt von: Rothenbusch
 Blatt: 24

KLEMMENKAST KLEMMENKASTEN CONNECTION BOX

WARTEL KABELEINF. GLAND NR.	KLEM KLEMMEN TERMINAL NR	FUNKTIE	FUNKTION	FUNCTION
1.1	φ 13	Voeding +12V	Speisung +12V	Power Supply +12V
1.2	GND	Voeding GND	Speisung GND	Power Supply GND
1.1	φ 1	+ Generator	+ Generator	+ Generator
2	DIV/VAR	Diesel X5	Diesel X5	Diesel X5
3.1	φ 38-GND-X7	Scheefstand	Neigung	Inclination
3.2	DIV/VAR	Auto Niv.	Auto Niv.	Auto Niv.
4.1	φ 38-GND-X8	Scheefstand Opt.	Neigung Opt.	Inclination Opt.
4.2	DIV/VAR	4mtr. Afslag S1Q	4mtr. Ausschaltung S1Q	4mtr. Cut-out S1Q
5.1	YA-GND	Stempels LA in	Stuetzen LH ein	Jacks LR in
5.2	YB-GND	Stempels LA uit	Stuetzen LH aus	Jacks LR out
6.1	YC-GND	Stempels RA in	Stuetzen RH ein	Jacks RR in
6.2	YD-GND	Stempels RA uit	Stuetzen RH aus	Jacks RR out
7.1	Y6-GND	Stempels LV in	Stuetzen LV ein	Jacks LF in
7.2	Y7-GND	Stempels LV uit	Stuetzen LV aus	Jacks LF out
8.1	Y8-GND	Stempels RV in	Stuetzen RV ein	Jacks RF in
8.2	Y9-GND	Stempels RV uit	Stuetzen RV aus	Jacks RF out
9	DIV/VAR	Lasdoos voor X6	Verteilerdose vorn X6	Connect. Box front X6
10	DIV/VAR	Lasdoos achter X7	Verteilerdose hinten X7	Connect. Box rear X7
11.1	Y1.2-GND	Sper/Diff. Ventiel	Sperr/Diff. Ventil	Stip/Diff. Valve
11.2	Y1.3-GND	Sper/Diff. Ventiel	Sperr/Diff. Ventil	Stip/Diff. Valve
12.1	K9A:14-GND	Snelrijden	Schnell Fahren	Driving Fast
12.2	Y1-GND	Cir. Vent Ri.-St.	Cir. Vent. Fa.-St.	Cir. Valve Dr.-Ja.
13.1	K7A:14-GND	Rijden Vooruit	Fahren Vorwaerts	Driving Forward
13.2	K8A:14-GND	Rijden Achteruit	Fahren Rueckwaerts	Driving Reverse
14.1	Y1.6-GND	Heffen	Heben	Lift Up
14.2	Y1.0-GND	Cir. Ventiel Stempels	Cir. Ventil Stuetzen	Cir. Valve Jacks
15.1	Y2-GND	Sturen Links Voor	Lenken Links Vorn	Steering Left Front
15.2	Y3-GND	Sturen Rechts Voor	Lenken Rechts Vorn	Steering Right Front

WARTEL KABELEINF. GLAND NR.	KLEM KLEMMEN TERMINAL NR	FUNKTIE	FUNKTION	FUNCTION
16.1	Y30.8-GND	Hydr. Aggregaat Opt.	Hydr. Aggr. Opt.	Hydr. Aggr. Opt.
16.2	DIV/VAR	RPM Teller Gen. Opt.	RPM Zaehler Gen. Opt.	RPM Meter Gen. Opt.
17.1	Y30.9-GND	Relais Aggregaat Opt.	Relais Aggr. Opt.	Relais Aggr. Opt.
17.2	φ 39 -X1.4	Tank leeg	Tank Leer	Tank empty
18	DIV/VAR	WCD Onderwagen 6PM	WCD Unterwagen 6PM	Socket Below 6PM
19.1	Y30.7-GND	Zwaailamp	Blitzleuchte	Flashlight
19.2	Y30.7-GND	Zwaailamp	Blitzleuchte	Flashlight
20.1	DIV/VAR	Smeersysteem Opt.	Schmiere System Opt.	Grease System Opt.
20.2	DIV/VAR	Black-Box Opt.	Black-Box Opt.	Black-Box Opt.
21.1	φ 39 -X1.6	Temp. Hd. Olie	Temp. Hd. Oel	Temp. Hd. Oil
21.2	DIV/VAR	Koeler	Kuehler	Cooler
22.1	φ 14	+12V Omvormer	+12V Wandler	+12V Converter
22.2	φ 15	+24V Omvormer	+24V Wandler	+24V Converter
22.3 & .4	GND	GND Omvormer	GND Wandler	GND Converter

this drawing is property of Holland Lift International, by all rights reserved
 diese zeichnung ist eigentum von Holland Lift International, by alle rechte vorbehalten
 deze tekening is eigendom van Holland Lift International, by auteursrecht voorbehouden volgens de wet

HOLLAND LIFT

Holland Lift International B.V.
 Anodeweg 1
 NL-1627 LJ Hoorn The Netherlands
 T/F +31 (0)229-285555 / 285550
 E service@hollandlift.com
 W www.hollandlift.com

KASTEN/BEKABELING
 KASTEN/KABEL
 BOXES/CABLES

Projekt:	EQ-23-001	Zeichnungsnummer:	Rev.:	A	erstellt von:	Rothenbusch
Datum:	31.05.2017	Anlage:	Ort:	=	Blatt:	25

LASDOOS AFSLAGEN
 VERTEILERDOSE HOEHEAUSSCHALTUNG
 MAXIMUM HEIGHT DISTRBUOR BOX

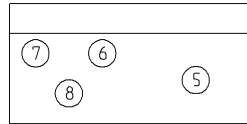
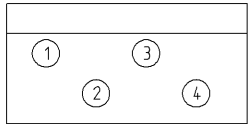
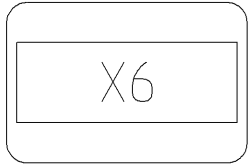

1-4/6-8 M12
 5 PG16

LASDOOS ACHTER
 VERTEILERDOSE HINTEN
 DISTRBUOR BOX REAR

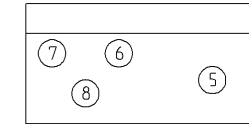
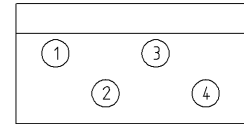
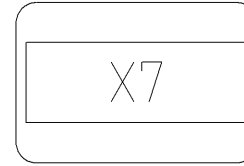

1-4/6-8 M12
 5 PG16

WARTEL KABELEINF. GLAND NR. (X6)	Omschrijving	Beschreibung	Descreption
1	Eindschak. LV in S9Q	Endschalter LV ein S9Q	Limit Switch LF in S9Q
2	Eindschak. LV uit S13Q	Endschalter LV aus S13Q	Limit Switch LF out S13Q
3	Eindschak. RV in S10Q	Endschalter RV ein S10Q	Limit Switch RF in S10Q
4	Eindschak. RV uit S14Q	Endschalter RV aus S14Q	Limit Switch RF out S14Q
5	Kabel Klemmenkast	Kabel Klemmenkasten	Cable Connection Box
6	Druk Meting	Druck Messung	Pressure Measuring
7	Hoekmeting	Winkel Messung	Angle Measuring
8	Dalen	Senken	Lift Down

WARTEL KABELEINF. GLAND NR. (X6)	Omschrijving	Beschreibung	Descreption
1	Eindschak. LA in S11Q	Endschalter LA ein S11A	Limit Switch LR in S11Q
2	Eindschak. LA uit S15Q	Endschalter LA aus S15Q	Limit Switch LR out S15Q
3	Eindschak. RA in S12Q	Endschalter RA ein S12Q	Limit Switch RR in S12Q
4	Eindschak. RA uit S16Q	Endschalter RA aus S16Q	Limit Switch RR out S16Q
5	Kabel Klemmenkast	Kabel Klemmenkasten	Cable Connection Box
6	Pendelas Rechts	Pendel Rechts	Oscillating Right
7	Pendelas Links	Pendel Achse Links	Oscillating Left
8	Pendelas Horizontaal S18Q	Pendel Achse Hor. S18Q	Oscillating Axle S18Q

this drawing is property of Holland Lift International, by all rights reserved.
 deze tekening is eigendom van Holland Lift International, by auteursrecht voorbehouden volgens de wet

BEDIENINGSKAST STEUERPULT CONTROL BOX

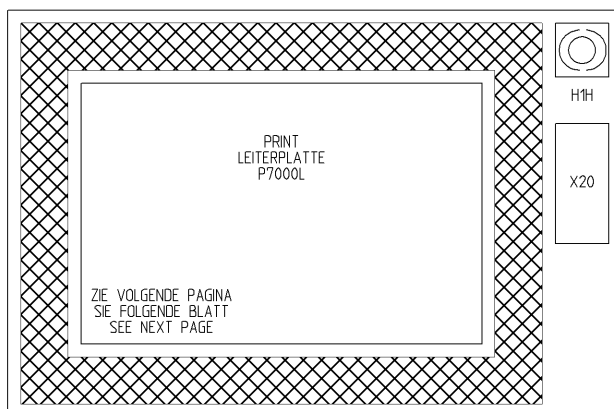
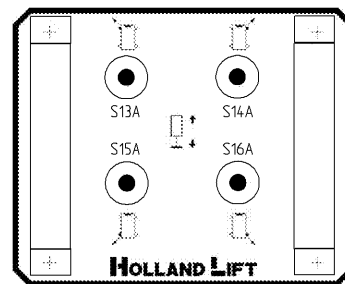
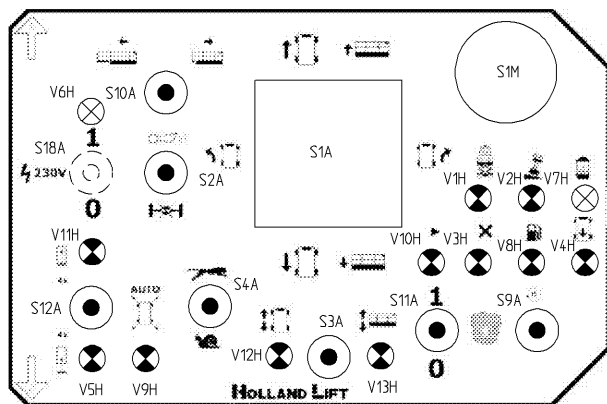

Colour schedule			
Colour	Dutch	English	Deutsch
Rd	Rood	Red	Rot
Bl	Blauw	Blue	Blau
Gl	Geel	Yellow	Gelb
Gn	Groen	Green	Gruen
Zw	Zwart	Black	Schwarz
Wt	Wit	White	Weiss
Bn	Bruin	Brown	Braun
Rs	Roze	Pink	Rosa
Or	Oranje	Orange	Orange
Ps	Poars	Violet	Violett
Tp	Transp.	Transp.	Transp.
Gs	Grijs	Grey	Grau

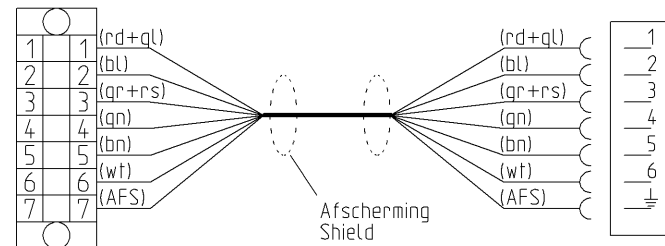
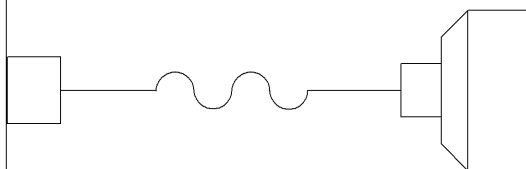

this drawing is property of Holland Lift International, by all rights reserved
 deze tekening is eigendom van Holland Lift International, by auteursrecht voorbehouden volgens de wet

HOLLAND LIFT

Holland Lift International B.V.
 Anodeweg 1
 NL-1627 LJ Hoorn The Netherlands
 T/F +31 (0)229-285555 / 285550
 E service@hollandlift.com
 W www.hollandlift.com

KASTEN/BEKABELING
 KASTEN/KABEL
 BOXES/CABLES

Projekt: EQ-23-001

Zeichnungsnummer:

Rev.: A

erstellt von:
 Rothenbusch

Datum: 31.05.2017

Anlage: =

Ort: +

Blatt: 27

PRINTPLAAT
LEITERPLATTE
CIRCUIT BOARD

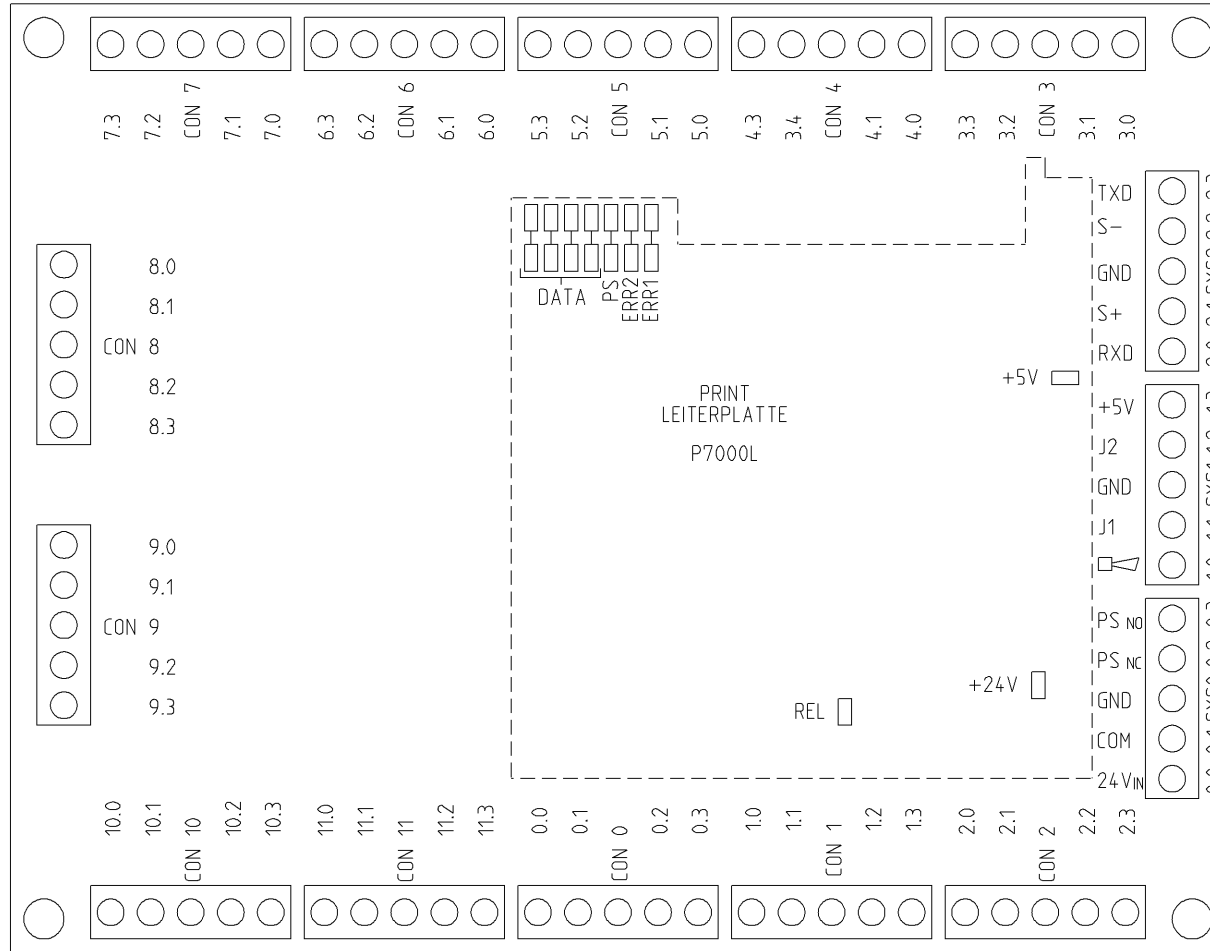

+24V	<input type="checkbox"/>	Groen/Gruen/Green	Voeding Ok	Speisung Ok	Supply Ok
+5V	<input type="checkbox"/>	Groen/Gruen/Green	Voeding Ok	Speisung Ok	Supply Ok
REL	<input type="checkbox"/>	Groen/Gruen/Green	Power Safe aan	Power Safe an	Power Safe on
PS	<input type="checkbox"/>	Geel/Gelb/Yellow	Power Safe uit	Power Safe aus	Power Safe off
Err1	<input type="checkbox"/>	Geel/Gelb/Yellow	Slechte Data Verbinding	Schlechte Data Verbindung	Poor Data Connection
Err2	<input type="checkbox"/>	Rood/Rot/Red	Geen Data Verbinding	Keine Data Verbindung	No Data Connection

this drawing is property of Holland Lift International, by all rights reserved.
 diese zeichnung ist eigentum von Holland Lift International, by urheberrecht vorbehalten nach dem gesetz.
 deze tekening is eigendom van Holland Lift International, by auteursrecht voorbehouden volgens de wet.

HOLLAND LIFT

Holland Lift International B.V.
 Anodeweg 1
 NL-1627 LJ Hoorn The Netherlands
 T/F +31 (0)229-285555 / 285550
 E service@hollandlift.com
 W www.hollandlift.com

PRINTPLAAT
LEITERPLATTE
CIRCUIT BOARD

Projekt:
EQ-23-001

Zeichnungsnummer:

Rev.: A

erstellt von:
Rothenbusch

Datum:
31.05.2017

Anlage:

Ort:
= +

Blatt:
28

this drawing is property of Holland Lift International, by all rights reserved.
 deze tekening is eigendom van Holland Lift International, by all rights reserved.
 deze tekening is eigendom van Holland Lift International, by auteursrecht voorbehouden volgens de wet

0.0	Joystick Op (S1A2)	Fahren Joy. Auf (S1A2)	Joystick On (S1A2)
0.1	Joystick Neer (S1A3)	Fahren Joy. Nied. (S1A3)	Joystick Down (S1A3)
CON 0			
0.2	Sturen Links (S1A4)	Lenken Links (S1A4)	Steering Left (S1A4)
0.3	Sturen Rechts (S1A5)	Lenken Rechts (S1A5)	Steering Right (S1A5)

1.0	Claxon (S2A3)	Hupe (S2A3)	Horn (S2A3)
1.1	Sper/Diff. (S2A1)	Sperr/Diff. (S2A1)	Slip/Diff. (S2A1)
CON 1			
1.2	Heffen/Dalen (S3A1)	Heben/Senken (S3A1)	Lift Up/Down (S3A1)
1.3	Rijden/Sturen (S3A3)	Fahren/Lenken (S3A3)	Driving/Steering (S3A3)

2.0	Snel Rijden (S4A)	Schnell Fahren (S4A)	Driving Fast (S4A)
2.1	Toerental (S9A)	Drehzahl (S9A)	Enging Speed (S9A)
CON 2			
2.2	Reserve	Reserve	Spare
2.3	Dodemansknop (S1A1)	Totmansknopf (S1A1)	Dead Man (S1A1)

0.0	Voeding +24V (S1M)	Speisung +24V (S1M)	Supply +24V (S1M)
0.1	Voeding +24V (S1M)	Speisung +24V (S1M)	Supply +24V (S1M)
SYS0 GND	GND	GND	GND
0.2	Reserve	Reserve	Spare
0.3	Voeding +24V (PS)	Speisung +24V (PS)	Supply +24V (PS)

1.0	+ Zoemer (H1H)	+ Summer (H1H)	+ Buzzer (H1H)
1.1	0-5V Joystick P1	0-5V Joystick P1	0-5V Joystick P1
SYS1 GND	- Zoemer (H1H)	- Summer (H1H)	- Buzzer (H1H)
1.2	Reserve (0-5V)	Reserve (0-5V)	Spare (0-5V)
1.3	Voeding +5V Joy. (P1)	Speisung +5V Joy. (P1)	Supply +5V Joy. (P1)

2.0	Data RXD	Data RXD	Data RXD
2.1	Data S+ (RS485)	Data S+ (RS485)	Data S+ (RS485)
SYS2 GND	Reserve	Reserve	Spare
2.2	Data S- (RS485)	Data S- (RS485)	Data S- (RS485)
2.3	Data TXD	Data TXD	Data TXD

3.0	Reserve	Reserve	Spare
3.1	Reserve	Reserve	Spare
CON 3			
3.2	4x Stempels in (S12A1)	4x Stuetzen ein (S12A1)	4x Jacks in (S12A1)
3.3	4x uit Au. Niv. (S12A3)	4x aus Au. Niv. (S12A3)	4x out Au. Niv.(S12A3)

4.0	Reserve	Reserve	Spare
4.1	Gen. aan Opt. (V6H)	Gen. an Opt. (V6H)	Gen. on Opt. (V6H)
CON 4			
4.2	Scheefstand gn (V2H)	Neigung gn (V2H)	Inclination (V2H)
4.3	Scheefstand rd (V2H)	Neigung rt (V2H)	Inclination rd (V2H)

5.0	Vetpomp Opt. (V7H)	Fett Pumpe Opt. (V7H)	Grease Pu. Opt. (V7H)
5.1	Overload (V1H)	Ueberspannung (V1H)	Overload (V1H)
CON 5			
5.2	Reserve	Reserve	Spare
5.3	Tank leeg (V8H)	Tank leer (V8H)	Tank empty (V8H)

6.0	Start Motor (S11A3)	Start Motor (S11A3)	Start Engine (S11A3)
6.1	Stop Motor (S11A1)	Halte Motor (S11A1)	Stop Engine (S11A1)
CON 6			
6.2	Gen. aan Opt. (S18A3)	Gen. an Opt. (S18A3)	Gen. on Opt. (S18A3)
6.3	Gen. uit Opt. (S18A1)	Gen. aus Opt. (S18A1)	Gen. off Opt. (S18A1)

7.0	Stempels LA in (S15A1)	Stuetzen LH ein (S15A1)	Jacks LR in (S15A1)
7.1	Stemp. LA uit (S15A3)	Stuetzen LH aus (S15A3)	Jacks LR out (S15A3)
CON 7			
7.2	Stempels RA in (S16A1)	Stuetzen RH ein (S16A1)	Jacks RR in (S16A1)
7.3	Stemp. RA uit (S16A3)	Stuetzen RH aus (S16A3)	Jacks RR out (S16A3)

8.0	Stempels LV in (S13A1)	Stuetzen LV ein (S13A1)	Jacks LF in (S13A1)
8.1	Stemp. LV uit (S13A3)	Stuetzen LV aus (S13A3)	Jacks LF out (S13A3)
CON 8			
8.2	Stempels RV in (S14A1)	Stuetzen RV ein (S14A1)	Jacks RF in (S14A1)
8.3	Stemp. RV uit (S14A3)	Stuetzen RV aus (S14A3)	Jacks RF out (S14A3)

9.0	Pendelas Hor. (V4H)	Pendel Achse Hor. (V4H)	Os. Axle Hor. (V4H)
9.1	Stempels in (V11H)	Stuetzen ein (V11H)	Jacks in (V11H)
CON 9			
9.2	Stempels uit (V5H)	Stuetzen aus (V5H)	Jacks out (V5H)
9.3	Auto Niv. (V9H)	Auto Niv. (V9H)	Auto Niv. (V9H)

10.0	In Bedrijf (V10H)	In Betrieb (V10H)	Run (V10H)
10.1	Storing Dieselm. (V3H)	Stoerung Dieselm. (V3H)	Failure Dieselm. (V3H)
CON 10			
10.2	Reserve	Reserve	Spare
10.3	Reserve	Reserve	Spare

11.0	Rijden/Sturen (V12H)	Fahren/Lenken (V12H)	Driving/Steering (V12H)
11.1	Heffen/Dalen (V13H)	Heben/Senken (V13H)	Lift Up/Down (V13H)
CON 11			
11.2	Hybrid Mode (V14H)	Hybrid Mode (V14H)	Hybrid Mode (V14H)
11.3	Electric Mode (V15H)	Elektro Mode (V15H)	Electric Mode (V15H)



Holland Lift International B.V.
 Anodeweg 1
 NL-1627 LJ Hoorn The Netherlands
 T/F +31 (0)229-285555 / 285550
 E service@hollandlift.com
 W www.hollandlift.com

PRINTPLAAT
 LEITERPLATTE
 CIRCUIT BOARD

Projekt:	EQ-23-001	Zeichnungsnummer:	Rev.:	A	erstellt von:	Rothenbusch
Datum:	31.05.2017	Antage:	Ort:	+	Blatt:	29